

Features

- Solid Surface
- Pilot holes for 8" (203 mm) widespread, 4" (102 mm) centerset, or single faucet
- 73-5/8" (1870 mm) x 22-13/16" (579 mm)
- Pre-cut for Verticyl® (K-2881) or other 17" (432 mm) x 14" (356 mm) oval under-mount bathroom sinks (required)

Components

Additional included component/s: Mounting Screws.



Codes/Standards





None Applicable

KOHLER® One-Year Limited Warranty

See website for detailed warranty information.

Available Color/Finishes

Color tiles intended for reference only.

Color	Code	Description
	S33	White Expressions
	S34	Almond Expressions
	S35	Biscuit Expressions
	S36	Ice Grey Expressions

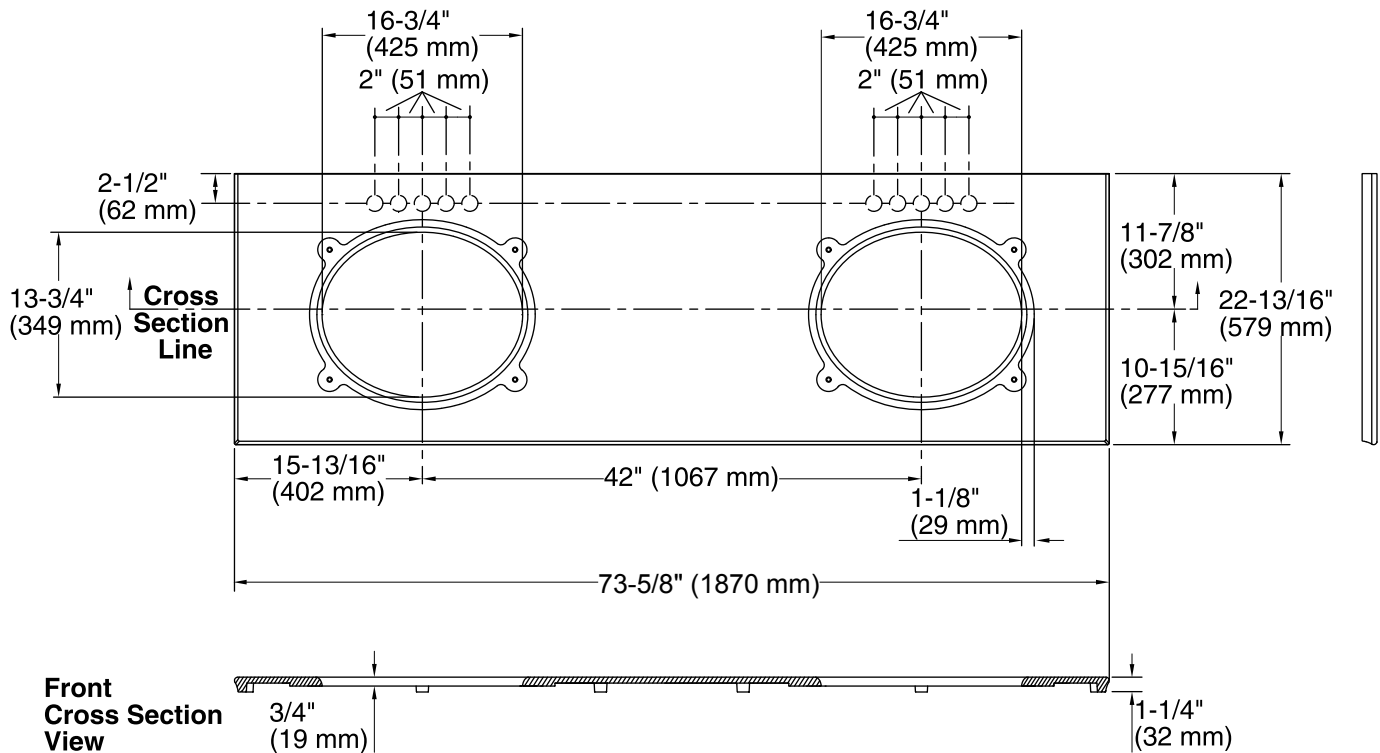

Technical Information

All product dimensions are nominal.

Bowl configuration: Double equal

Installation: Vanity top

Bowl area (Left) Length: 16-3/4" (425 mm)

Width: 13-3/4" (349 mm)

Bowl area (Right) Length: 16-3/4" (425 mm)

Width: 13-3/4" (349 mm)

Notes

Install this product according to the installation instructions.

Observe all local plumbing and building codes.

This countertop is designed to be installed with a KOHLER or standard-size vanity.

Faucet hole and sink-mounting locations are marked on the underside of the countertop.