

### Features

- Recess or surface mount
- Ideal for remodeling: features 1" (2.5 cm) flange to hide gaps, paint lines or any wall imperfections
- Slow-close functionality
- 108-degree in-set adjustable hinge
- Clean interior due to "hidden" shelf adjustments and off-set door hinge (patent pending)
- 3 Mirror construction: front of door, back of door and inside of cabinet
- Low-profile laminated door design
- Thin door and off-set hinge allow for more storage than any cabinet of similar size
- Anodized aluminum construction
- Can be installed as a left- or right-hand door swing
- Four adjustable, cantilever glass shelves
- 20" (50.8 cm) W x 36" (91.4 cm) H x 4-3/4" (12.1 cm) D

## RC2036D4FB1

ALSO RC2036D4FP1

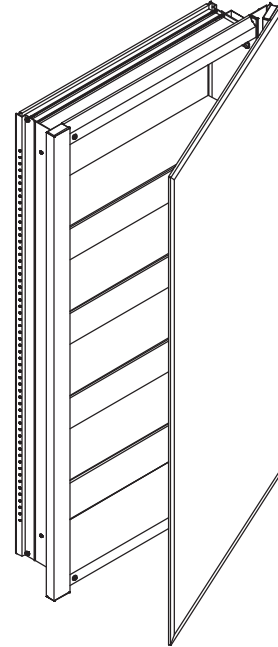

### Codes/Standards Applicable

Specified model meets or exceeds the following:

- None applicable

### Specified Model

Model	Description	
RC2036D4FB1	Beveled edge	<input type="checkbox"/>
RC2036D4FP1	Plain edge	<input type="checkbox"/>
<b>Required Accessories - For Surface Mount Installations Only</b>		
RSMK36D4P	Plain mirror side kit with mounting hardware	<input type="checkbox"/>

# R<sup>3</sup>™ SERIES FLAT DOOR CABINET

## Technical Information

Roughing-in opening	18" (45.7 cm) W x 34" (86.4 cm) H x 4" (10.2 cm) D
Door opening angle	108°

## Installation Notes

Install this product according to the installation guide.

When determining the height of the mirrored cabinet, ensure the mirrored door will clear all obstacles, such as a faucet. A minimum distance of 1" (2.5 cm) is required.

Secure the screws (provided) to a stud to avoid possible property and product damage. If this is not possible, anchors (provided) must be inserted before installing the screws.

Recessed cabinets project 1" (2.5 cm) from wall.

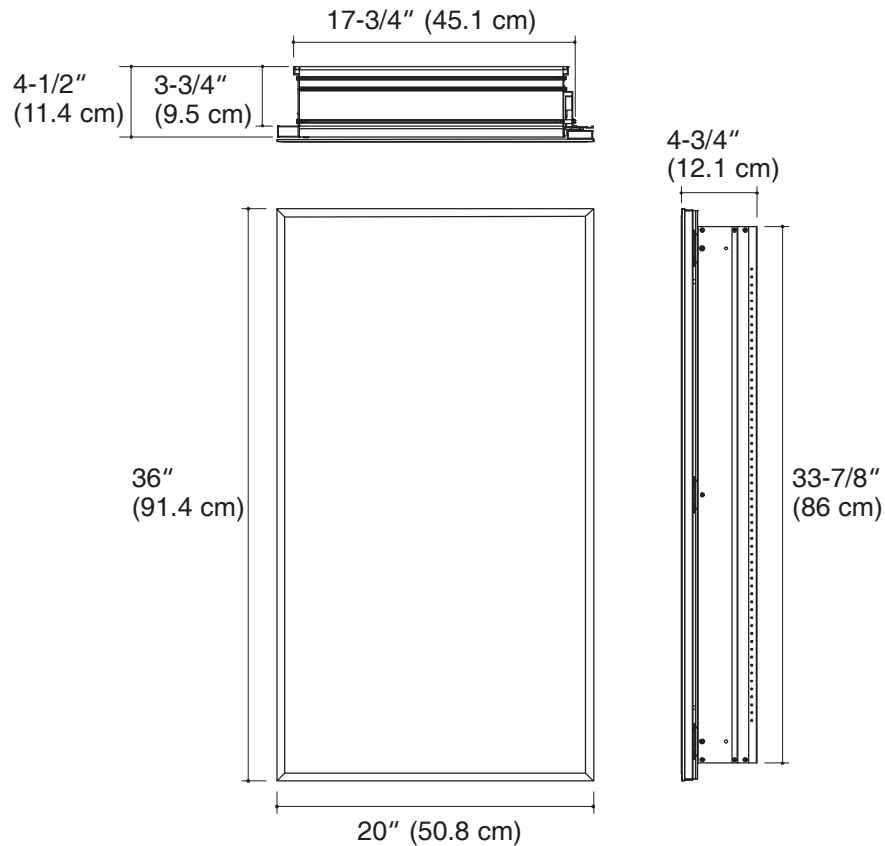

## Product Diagram