

PLEASE CONTACT TRANSOLID FIRST
For Installation Help, Missing or Replacement Parts

(USA)
1-877-632-6322
Mon-Fri 8am – 7pm EST
Saturday 8am – 12pm

POR FAVOR, CONTÁCTESE PRIMERO CON TRANSOLID

Para obtener ayuda de instalación, piezas faltantes o de recambio

1-877-632-6322
Lunes a viernes de 8:00 a 7 hs. (Costa Este)
sábado 8:00 a 12 hs. (Costa Este)

HELPFUL TOOLS

For safety and ease of faucet replacement, Moen recommends the use of these helpful tools.

HERRAMIENTAS ÚTILES

Para que el cambio de la llave sea fácil y seguro, Moen le recomienda usar estas útiles herramientas.

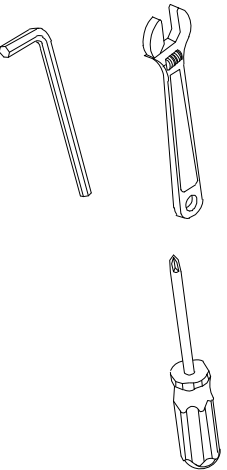

Deck mount single handle pull-out kitchen faucet
Grifo para lavabo de cocina

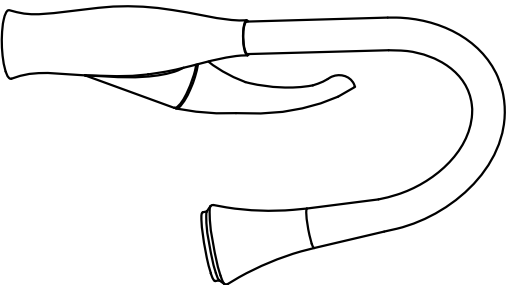

Image is for Reference only
(Style varies by model)

La imagen es sólo como referencia

(El estilo varía por el modelo)

NOTE: This faucet is designed to be installed thru 1 hole; $\Phi 1\text{-}3/8"$ min.

Nota: Este grifo está diseñado para ser instalado a través del orificio de 1, $\Phi 1\text{-}3/8"$ min.

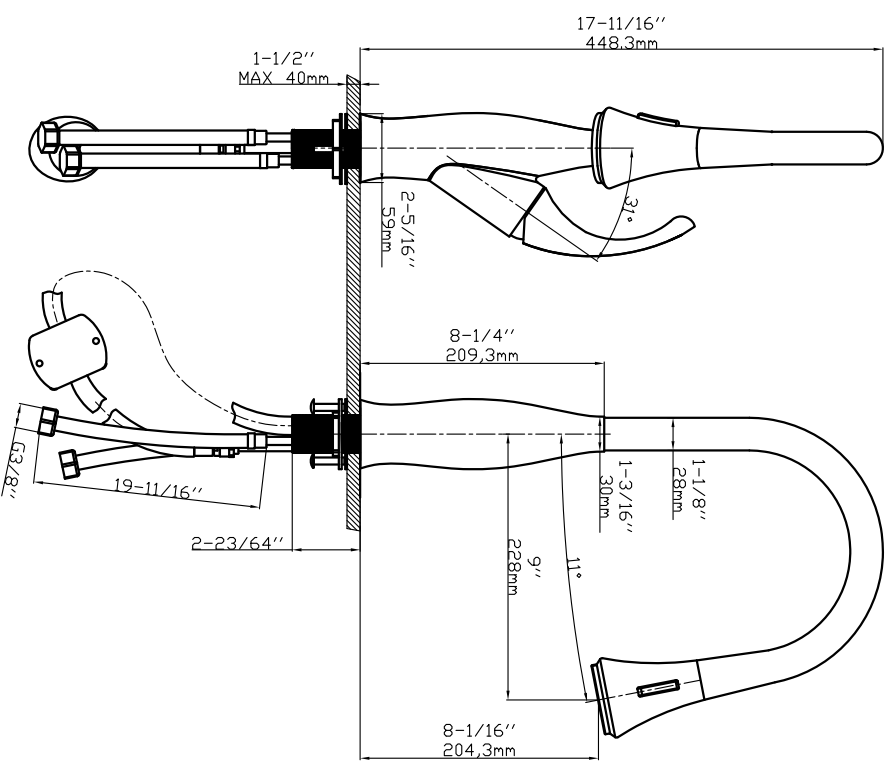
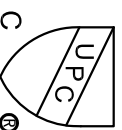

CRITICAL DIMENSIONS
DIMENSIONES CRÍTICAS

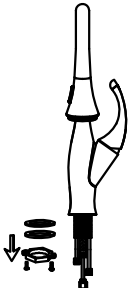
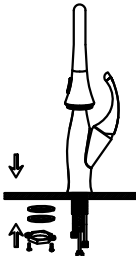
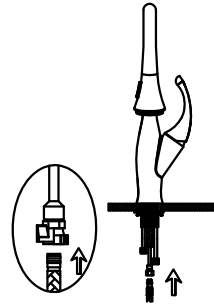
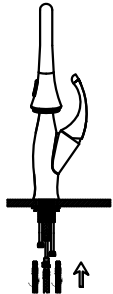
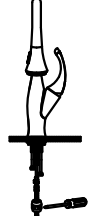
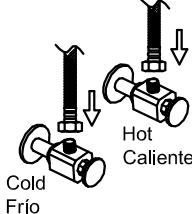
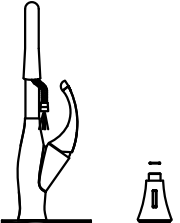
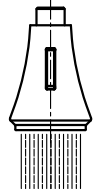
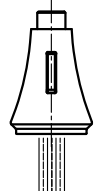
 <p>1. Remove locking-nut, metal and rubber washer and hose connector if installed.</p> <p>1. Retire la tuerca de bloqueo, la arandela de metal y de goma y el conector de manguera si está instalado.</p>	 <p>2. Install faucet through center hole, re-install rubber and metal washer followed by the lock-nut. Re-install hose connector if removed insuring small rubber washer is also installed. Using a screwdriver tighten the lock-nut screws so that the faucet is secure and will not twist.</p> <p>2. Instale el grifo a través del orificio central, vuelva a instalar el caucho y la arandela de metal seguido de la contratuerca. Vuelva a instalar el conector de la manguera si se retira asegurando que también se instala una arandela de goma pequeña. Usando un destornillador, apriete los tornillos de la tuerca de bloqueo para que el grifo esté seguro y no gire.</p>	 <p>3. Push pull-out hose in to the hose connector until you hear a click sound.</p> <p>3. Empuje la manguera de extracción hasta el conector de la manguera hasta que escuche un sonido de clic.</p>
 <p>4. Screw and tighten the hot and cold flexible lines to the corresponding faucet connectors. Using a wrench ensure that the copper faucets lines are stable as you tighten the braided feed lines.</p> <p>4. Atornille y apriete las linea.</p>	 <p>5. Proper installation of the hose weight kit will ensure that the spray head retracts smoothly. On the spray side of the hose, measure 15" down from the body of the faucet. Install the hose weight kit at this point. Pull out on the spray head. It should move easily and retract smoothly. Reposition the hose weight kit as necessary.</p>	 <p>6. Attach flexible hose to water supply.</p>
 <p>7. Hold on to the spray-head hose, unscrew spray head and remove it along with the rubber washer. Turn on the faucet to flush the hose and feed line for 1-minute to flush debris. Turn off faucet and re-install the rubber washer and spray head.</p>	 <p>8. Turn the faucet on and press the top of the spray head button to change to Spray.</p>	 <p>9. Turn the faucet on and press the bottom of the spray head button to change to stream.</p>

Cleaning Instructions

Transolid recommends cleaning the finish with a mild soap, rinsing thoroughly with warm water and drying with a clean, soft cloth. Never use cleaners containing abrasives (including abrasive sponges or steel wool), ammonia, bleach or sodium hypochlorite, organic solvents (e.g. alcohols) or other harsh chemicals (e.g. lime scale removers) to clean the finish, as they may damage the finish. Failure to comply with these cleaning instructions may void Transolid's warranty.

Limited Lifetime Warranty

Transolid products have been manufactured under the highest standards of quality and workmanship. Transolid warrants to the original consumer purchaser for as long as the original consumer purchaser owns their home (the "Warranty Period" for homeowners), that this faucet will be leak- and drip-free during normal use and all parts and finishes of this faucet will be free from defects in material and manufacturing workmanship. All other purchasers (including purchasers for industrial, commercial and business use) are warranted for a period of 5 years from the original date of purchase (the "Warranty Period" for non-homeowners).

If this faucet should ever develop a leak or drip during the Warranty Period, Transolid will FREE OF CHARGE provide the parts necessary to put the faucet back in good working condition and will replace FREE OF CHARGE any part or finish that proves defective in material and manufacturing workmanship, under normal installation, use and service. Replacement parts may be obtained by calling 1-877-632-6322, or by writing to the address shown. Proof of purchase (original sales receipt) from the original consumer purchaser must accompany all warranty claims. Defects or damage caused by the use of other than genuine Transolid parts is not covered by this warranty. This warranty is effective from the date of purchase as shown on purchaser's receipt.

This warranty is extensive in that it covers replacement of all defective parts and finishes. However, damage due to installation error, product abuse, product misuse, or use of cleaners containing abrasives, alcohol, or other organic solvents, whether performed by a contractor, service company, or yourself, are excluded from this warranty. Transolid will not be responsible for labor charges and/or damage incurred in installation, repair or replacement, nor for any indirect, incidental or consequential damages, losses, injury or costs of any nature relating to this faucet. Except as provided by law, this warranty is in lieu of and excludes all other warranties, conditions and guarantees, whether expressed or implied, statutory, or otherwise, including without restriction those of merchantability or of fitness for use.

Some states, provinces and nations do not allow the exclusion or limitation of incidental or consequential damages, so the above limitations or exclusions may not apply to you. This warranty gives you specific legal rights and you may also have other rights which vary from state to state, province to province, nation to nation. Transolid will advise you of the procedure to follow in making warranty claims. Simply write to Transolid using the address below. Explain the defect and include proof of purchase and your name, address, area code and telephone number.