

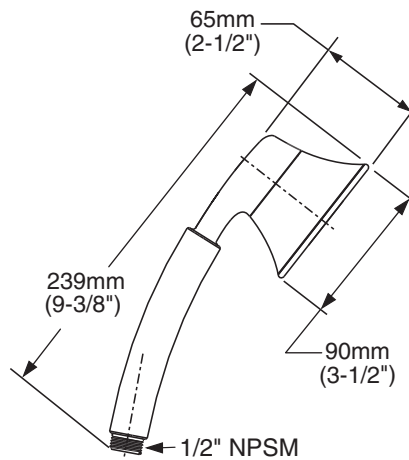

MODEL NUMBER:

- 1660.741 FloWise® Transitional Water Saving Hand Shower



GENERAL DESCRIPTION:

Hand shower uses 40% less water than standard 2.5gpm hand showers. Hand shower rated at 1.5gpm/5.7L/min. maximum flow rate. Hand shower has single spray function using Turbine Technology. Pressure compensating flow control device. Includes check valve.

PRODUCT FEATURES:

Water Saving: Saves 40% in water usage.

Pressure Compensating Flow Control Device: Provides consistent flow over a wide pressure range.

Single Function: Hand Shower provides drenching spray for full coverage of the user.

Easy Clean Spray Nozzles: Easily clean lime and calcium build up. Nozzles will not clog.

SUGGESTED SPECIFICATION

Hand shower shall save 40% in water usage. Hand shower shall always start at 1.5gpm/5.7L/min. Hand shower shall have a pressure compensating control device and shall include a check valve. Fitting shall be American Standard Model # 1660.741._____.





CODES AND STANDARDS

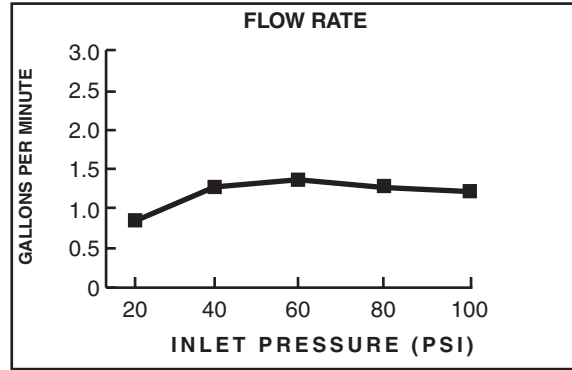

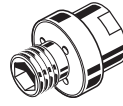

These products meet or exceed the following codes and standards:

ASME A112.18.1
CSA 125.1



Product Number	Description	Finish Options	
		Polished Chrome	PVD Satin Nickel
1660.741	FloWise® Transitional Water Saving Hand Shower	002	295

Hand Shower Accessories	
Product Number	Description
8888.035	59" Metal Shower Hose 
8888.053	79" Metal Shower Hose (Chrome Only) 
1660.400	Vacuum Breaker 
1660.410	Shower Arm Diverter 
8888.096	Shower Arm Bracket 

Hand Shower Accessories	
Product Number	Description
8888.036	Fixed Wall Bracket 
8888.037	Wall Supply 
8888.068	Round Wall Supply 
8888.069	Square Wall Supply 
8888.038	Wall Supply Bracket 