

# Gas Conversion-110C,310C,510C

1W5220  
100267297

This water heater is configured for Natural Gas from the factory. However, if a field conversion to Propane Gas is necessary, the conversion kit supplied with the water heater must be used and installed by a qualified service agency\*. Before you install the components in this Propane Gas conversion kit, verify the type of gas that will be used to fuel the unit. **An improper field conversion could cause potentially dangerous conditions that may cause an explosion or fire resulting in property damage, bodily injury or both.**



## WARNING



- This conversion kit shall be installed by a qualified service agency\* or a gas utility service technician in accordance with Manufacturer's written instructions and all applicable codes and requirements of the authority having jurisdiction. The information in these instructions must be followed to minimize the risk of fire or explosion or to prevent property damage, personal injury or death. The qualified service agency\* is responsible for the proper installation of this kit. The installation is not proper and complete until the operation of the converted appliance is checked as specified in the manufacturer's instructions supplied with the kit.
- If your water heater has been converted to use a different gas type in the past, the manufacturer does NOT recommend converting it again.
- IN CANADA, THE CONVERSION SHALL BE CARRIED OUT IN ACCORDANCE WITH THE REQUIREMENTS OF THE PROVINCIAL AUTHORITIES HAVING JURISDICTION AND IN ACCORDANCE WITH THE REQUIREMENTS OF THE CSA-B149.1, NATURAL GAS AND PROPANE INSTALLATION CODE.

\* A qualified service agency is any individual, firm, corporation or company which either in person or through a representative is engaged in and is responsible for the connection, utilization, repair or servicing of gas utilization equipment or accessories; who is experienced in such work, familiar with all precautions required, and has complied with all of the requirements of the authority having jurisdiction.

## Tools Required:

- Phillips Screwdriver / Manometer / Gas Leak Detector

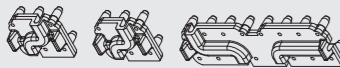
## Included Items: 319143-580

LP Gas Manifold Nozzles	Manifold gasket	Gas Conversion Label
		
Qty: 2 Small / 1 Large	Qty: 1 Part No. : 319143-581	Qty: 1



## WARNING

Before servicing the water heater, make sure that electrical power and gas service to the water heater is turned OFF. Failure to do so may result in bodily injury, death, or property damage.

## Procedure:

- Turn off power supply.
- Turn off both gas and water valves to the water heater.
- Remove the front cover.
- Once the front cover is removed, place it in a safe location to prevent accidental damage. With the internal components exposed, locate the gas manifold near the center of the unit.
- Use a Phillips screwdriver to remove **the 20 screws** on the manifold plate shown in Figure 1.
- Remove the manifold plate. (Figure 2)
- Remove the manifold gasket from the manifold plate. Discard it.
- Install the new manifold gasket onto the manifold plate. Ensure that the gasket is not compromised in any way. If it is, do not install the gasket. Replace it with a new one. (Part number: 319143-581)
- Refer to Figure 3 and identify the proper location for each LP Gas Manifold Nozzle. The nozzle attachments are of two types: One small and one large. The smaller nozzle attachments are for the left two sections and the larger one is for the right section.

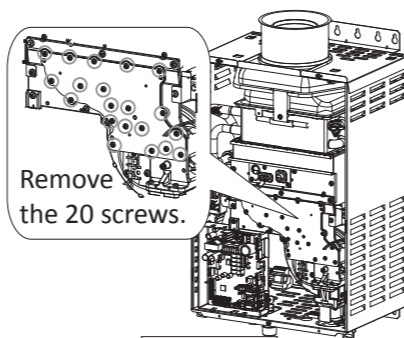

Figure 1

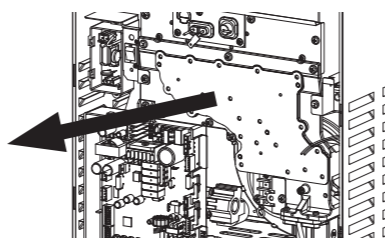

Figure 2



Ensure that each manifold nozzle includes a gasket prior to installation.

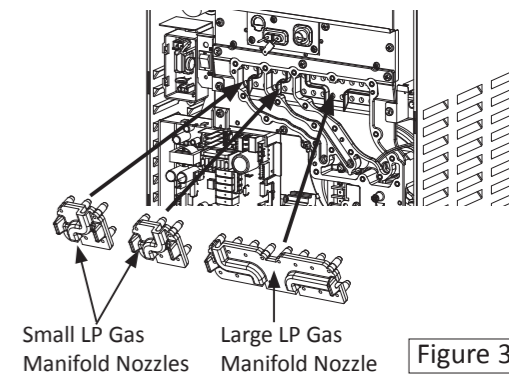

Figure 3

- Install each LP Gas Manifold Nozzle as shown in Figure 3.  
**NOTE:** The parts are keyed and cannot be installed incorrectly.
- After making sure that the manifold nozzles are secure, install the manifold cover using the 20 screws that were removed during step 5. See Figure 1.



Hand tighten the screws. Do not overtighten as this may damage or crack the components. Do not use a powered screwdriver.

- Set the Dip switches on the PCB to the correct position for propane. See the figures below for the proper propane DIP switch settings.

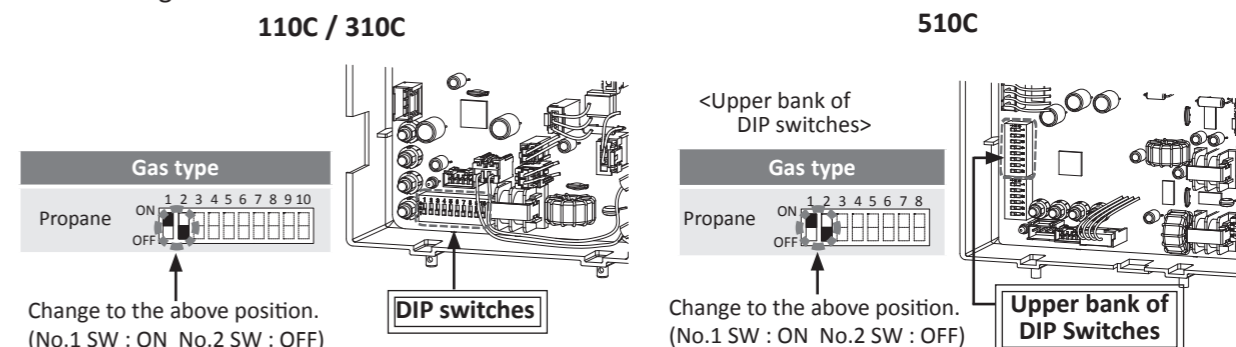

## WARNING

- Turn off the power before changing the DIP switch settings.
- Only change the DIP switches specified above for the conversion to propane.
- Failure to properly set the DIP switches could cause carbon monoxide poisoning, resulting in severe personal injury or death.

- Verify that the gas supply pressure is within an acceptable range. For instructions, see "Gas Supply and Gas Pipe Sizing for Propane" on the reverse side of this instruction sheet.

- Turn power ON and turn on the gas supply.

- Check for gas leaks around the manifold plate as follows:
  - Turn on a nearby hot water faucet.
  - Check for gas leaks by running a gas leak detector along the edges of the manifold plate. If you find a leak, do not proceed. Replace the manifold gasket with a new one. (Part number: 319143-581)

- Turn the water supply off.
- After the water heater has completed its post-purge process, turn off the gas supply and turn off power to the water heater
- Check the manifold pressures as described on the reverse side of this instruction sheet.
- Install the front cover with three screws.
- Fill out all items on the gas conversion sticker with a permanent marker. Affix the label on the heater as shown in Figure 4.
- Restart the water heater according to the Installation Manual and Owner's Guide. Verify proper operation before returning the water heater to service.

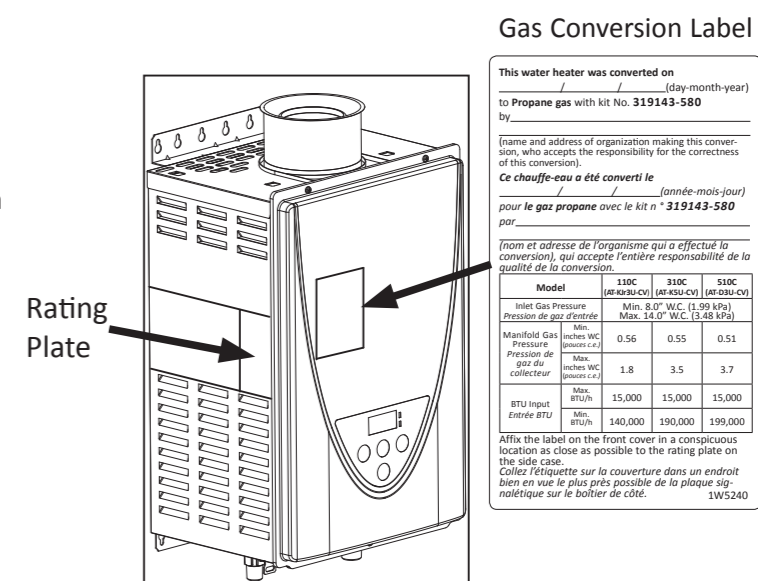

Figure 4

## Gas Conversion Label

This water heater was converted on \_\_\_\_\_ (day-month-year) to Propane gas with kit No. 319143-580 by \_\_\_\_\_

(name and address of organization making this conversion, who accepts the responsibility for the correctness of this conversion).

Ce chauffe-eau a été converti le \_\_\_\_\_ (année-mois-jour) pour le gaz propane avec le kit n° 319143-580 par \_\_\_\_\_

(nom et adresse de l'organisme qui a effectué la conversion), qui accepte l'entière responsabilité de la qualité de la conversion.

Model	110C (AF430-CV)	310C (AF450-CV)	510C (AF530-CV)
Inlet Gas Pressure (AF430-CV)	Min. 8.0" W.C. (1.99 kPa)	Max. 14.0" W.C. (3.48 kPa)	
Manifold Gas Pressure (AF430-CV)	Min. 0.56 inches WC	0.55	0.51
Pressure de gaz du collecteur (AF430-CV)	Max. 1.8 inches WC	3.5	3.7
BTU input, Entree BTU	Min. 15,000	15,000	15,000
	Max. 140,000	190,000	199,000

Affix the label on the front cover in a conspicuous location as close as possible to the rating plate on the side case.  
Collez l'étiquette sur la couverture dans un endroit bien en vue le plus près possible de la plaque signalétique sur le boîtier de côté.

1W5240

(continued overleaf)



Adjusting the manifold pressure can cause unexpected combustion conditions during operation, which can cause a health hazard, damage the water heater, and/or shorten its lifespan. Therefore, the manifold pressure must only be changed by a qualified service agency or a gas utility service technician in accordance with Manufacturer's written instructions and all applicable codes and requirements of the authority having jurisdiction.

### Checking maximum and minimum manifold pressure

- i. Ensure that the water heater is not in operation.
- ii. Remove the screw off the manifold port of the water heater. (Fig.A)
- iii. Connect a manometer to the manifold port using a silicon tube (Fig. B). Ensure that this connection is secure enough to prevent a gas leak.
- iv. Turn on power supply to the water heater.
- v. Turn on both gas and water valves to the water heater.
- vi. Turn on hot water fixtures to produce a high flow. If an isolation valve is installed, hook up a water hose to the hot outlet and run water at maximum rate.
- vii. Verify the MAX and MIN settings as follows:
  - a. Press and hold the "MAX" button on the computer board. (See Figure C.)
  - b. Compare the reading on the manometer to the values in the table below. If it does not fall within the acceptable range, refer to "Adjusting maximum manifold pressure."
  - c. Press and hold the "MIN" button on the computer board. (See Figure C.)
  - d. Compare the reading on the manometer to the values in the table below. If it does not fall within the acceptable range, refer to "Adjusting minimum manifold pressure."

### Adjusting maximum manifold pressure

- Press and hold down the "MAX" button on the computer board. While holding down the "MAX" button, press either the "Increase" or "Decrease" button to increase or decrease the manifold gas pressure, respectively (Fig. C). Do not push the increase or decrease button for more than two seconds at a time. Refer to the manometer to verify that pressure has been set to the desired value.

### Adjusting minimum manifold pressure

- Press and hold down the "MIN" button on the computer board. While holding down the "MIN" button, press either the "Increase" or "Decrease" button to increase or decrease the manifold gas pressure, respectively (Fig. C). Do not push the increase or decrease button for more than two seconds at a time. Refer to the manometer to verify that pressure has been set to the desired value.
- viii. After gas pressure has been set, turn off the power supply and turn off both gas and water valves. Next, remove the manometer tube, and replace the port screw securely. If the screw isn't fastened securely at this time, it may cause a gas leak.

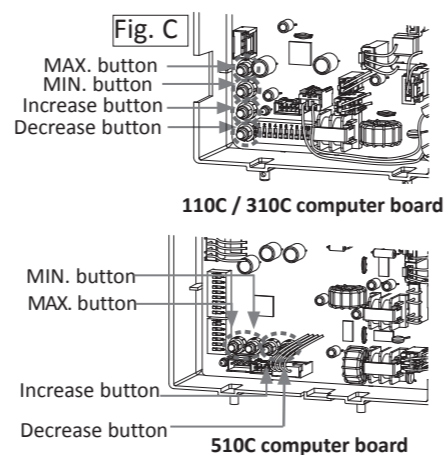
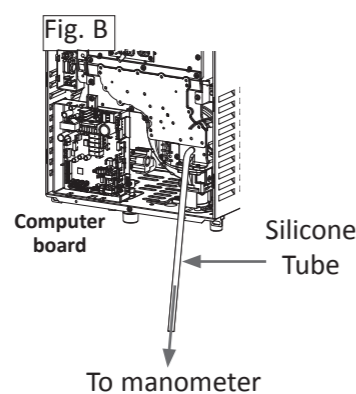
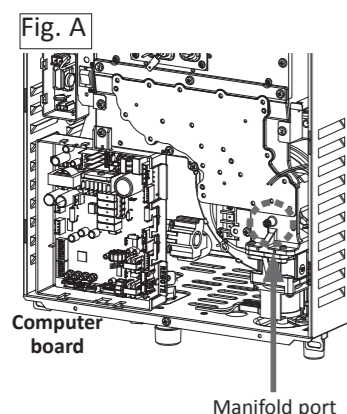

Models for Propane		110C		310C		510C	
Manifold Pressure	Inch W.C. (Pa)	Max.	1.5 to 1.8 (374 to 448)	Max.	2.7 to 3.5 (673 to 872)	Max.	2.9 to 3.7 (722 to 922)
		Min.	0.44 to 0.56 (110 to 139)	Min.	0.44 to 0.56 (110 to 139)	Min.	0.44 to 0.56 (110 to 139)
BTU Input	BTU/h	Max.	140,000	Max.	190,000	Max.	199,000
		Min.	15,000	Min.	15,000	Min.	15,000

## GAS SUPPLY AND GAS PIPE SIZING FOR PROPANE

- The minimum and maximum inlet gas pressures for propane are:

Gas type	Inlet gas pressure
Propane	Min. 8.0" W.C. (1.99 kPa) – Max. 14.0" W.C. (3.48 kPa)



- Size the gas pipe to supply the necessary volume of gas for the water heater. Refer to and follow the requirements listed in the current edition of ANSI Z223.1/NFPA 54 (USA), CAN/CSA B149.1 (Canada), or local codes. Otherwise, flow capabilities and output temperatures will be limited.
- When the gas connections are completed, it is necessary to perform a gas leak test either by applying soapy water to all gas fittings and observing for bubbles or by using a gas leak detection device.
  - i. The water heater and its individual shutoff valve must be disconnected from the gas supply piping system during any pressure testing of that system at test pressures in excess of 1/2 psi (3.5 kPa).
  - ii. The water heater must be isolated from the gas supply piping system by closing its individual manual shutoff valve during any pressure testing of the gas supply piping system at test pressures equal to or less than 1/2 psi (3.5 kPa).
- Regarding high altitude installation after gas conversion, refer to the section of "HIGH ALTITUDE INSTALLATIONS" in the installation manual. (P. 12)

### -Propane (LP) Supply Piping-

Maximum Capacity of Propane (LP) Based on 11" W.C. supply pressure at a 0.5" W.C. pressure drop

Unit: kBtu per hour

Pipe Size Diameter	Length												
	10' (3.0m)	20' (6.1m)	30' (9.1m)	40' (12.2m)	50' (15.2m)	60' (18.3m)	70' (21.3m)	80' (24.4m)	90' (27.4m)	100' (30.5m)	125' (38.1m)	150' (45.7m)	200' (61.0m)
1/2"	268	184	148	126	112	101	93	87	82	77	68	62	53
3/4"	567	393	315	267	237	217	196	185	173	162	146	132	112
1"	1,071	732	590	504	448	409	378	346	322	307	275	252	213
1 1/4"	2,205	1,496	1,212	1,039	913	834	771	724	677	630	567	511	440
1 1/2"	3,307	2,299	1,858	1,559	1,417	1,275	1,181	1,086	1,023	976	866	787	675
2"	6,221	4,331	3,465	2,992	2,646	2,394	2,205	2,047	1,921	1,811	1,606	1,496	1,260