

Brand AXOR
 Art. Name **AXOR Edge** Single-Hole Faucet 280, 1.2 GPM, without Pop-up Drain
 Art. Nr. 46030331
 Surface Polished Black Chrome
 Pos. 1

Product Picture



Features

- Handle design: lever handle
- Spray pattern: Aerated spray
- Maximum flow rate (at 3 bar): 4.5 l/min
- Ceramic cartridge

Drawing

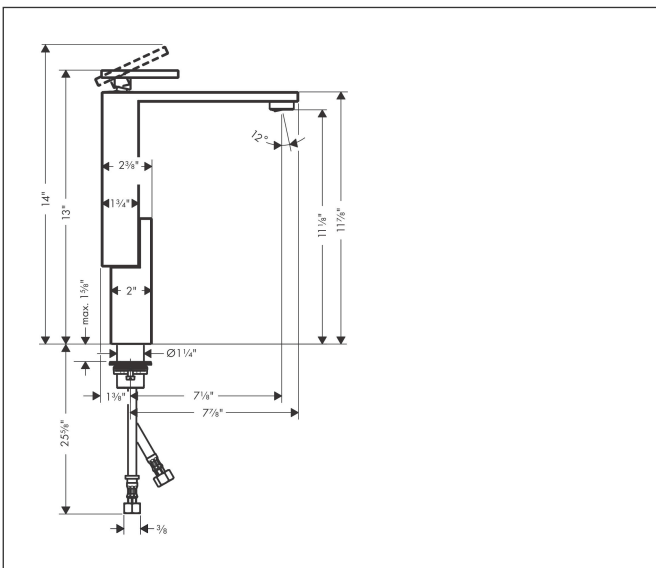

Technology



Brand AXOR
Art. Name **AXOR Edge** Single-Hole Faucet 280, 1.2 GPM, without Pop-up Drain
Art. Nr. 46030331
Surface Polished Black Chrome
Pos. 1

Spare Parts Drawings for build year: >04/20

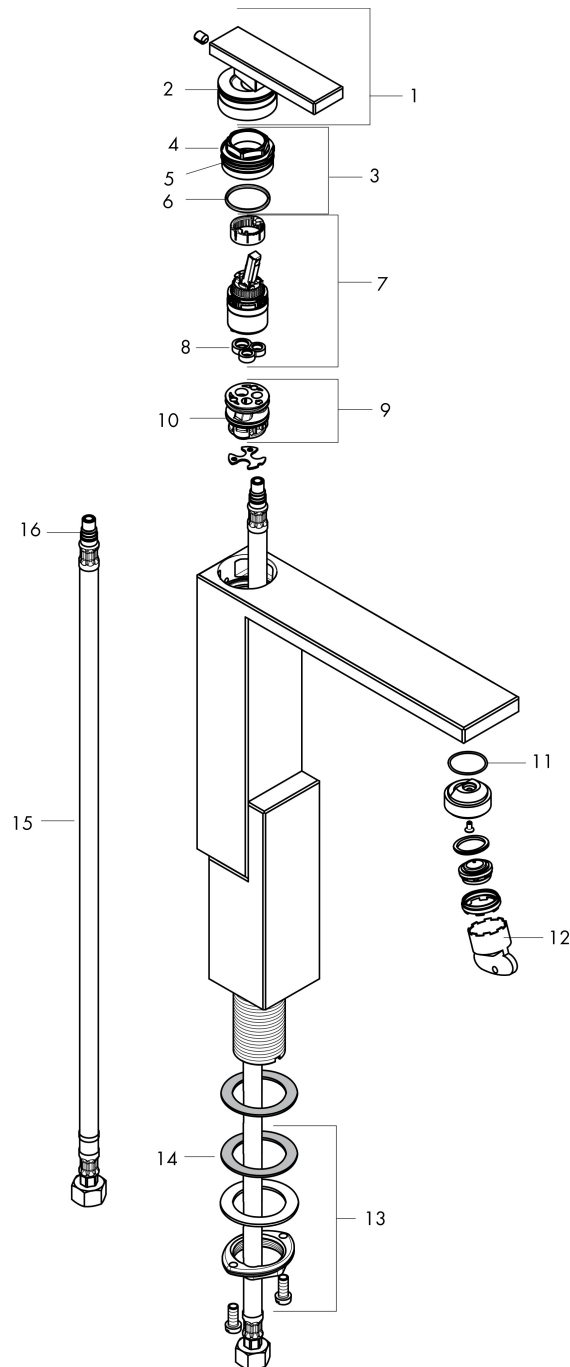

Brand AXOR
 Art. Name **AXOR Edge** Single-Hole Faucet 280, 1.2 GPM, without Pop-up Drain
 Art. Nr. 46030331
 Surface Polished Black Chrome
 Pos. 1

Spare parts list for build year: >04/20

Pos.	Description	Article number
2	O-ring 33x1,5	98164000
3	nut	92926000
4	O-ring 25x1,5	98146000
5	O-ring 30x1,5	98433000
6	O-ring 29x2	98391000
7	cartridge, assy	92900000
8	seal	93383000
9	adapter for cartridge	98866000
10	O-ring 23x2	98398000
11	O-ring 22x1,2	98397000
12	service tool	95661000
13	fixing set (Ø 32)	13961000
14	lever collar	97548000
15	connection hose 35½" M8x0,75 3/8"	96316001
16	O-ring 7x1,5	98422000