

AXOR Universal Accessories Toothbrush Tumbler

Surfaces: **Chrome** Article Number: **42834000**



Description

product features

- drilling distance 108 mm
- material: glass, metal
- wall-mounted
- adapter set no.42870000 must be used when installing on a rail

Design awards



Product image



Scale drawing

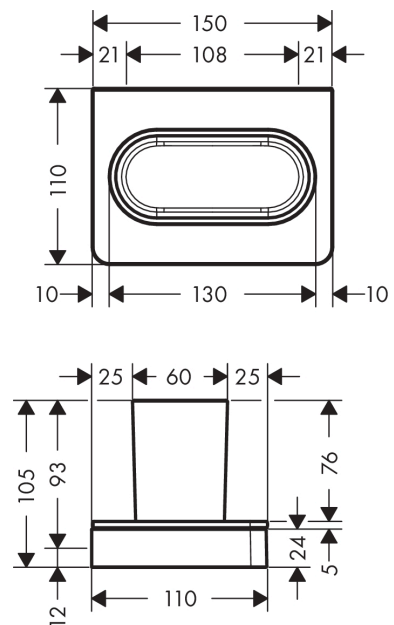

AXOR Universal Accessories

Toothbrush Tumbler

Surfaces: **Chrome** Article Number: **42834000**



Exploded Drawing

Year of production: >11/14

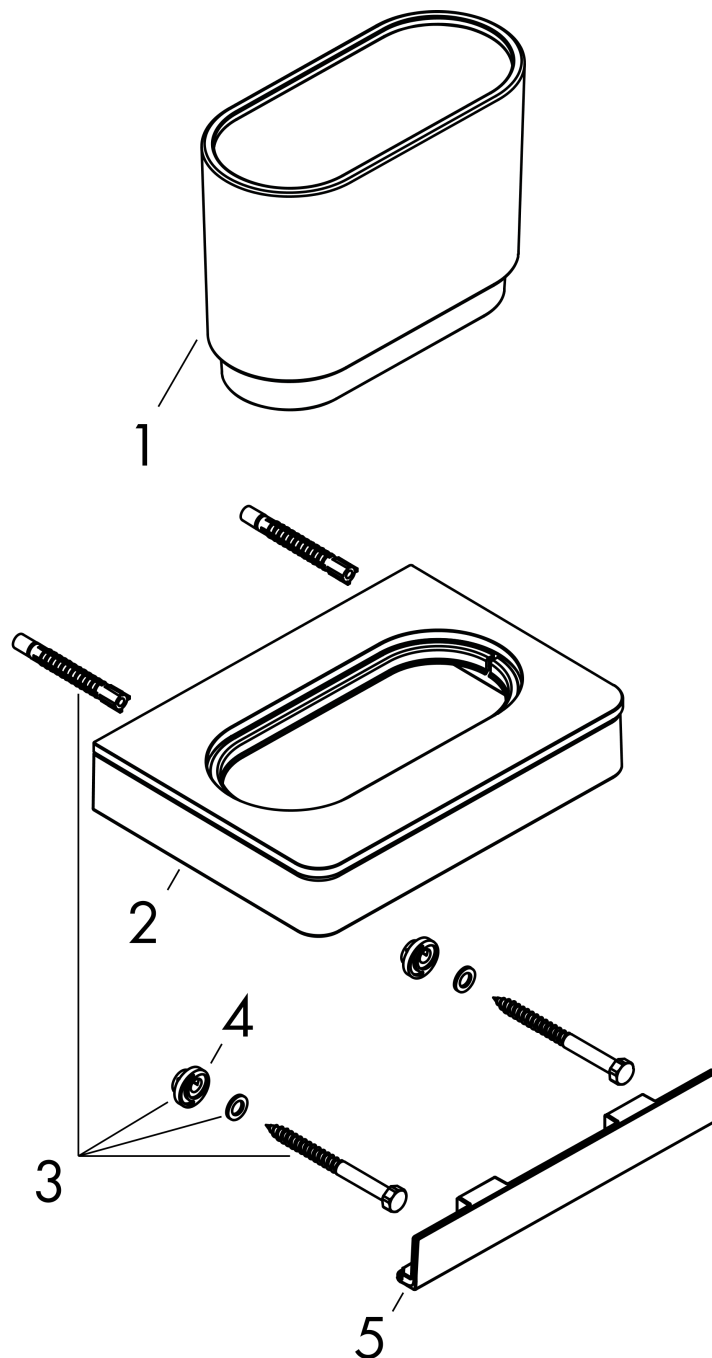

AXOR Universal Accessories

Toothbrush Tumbler

Surfaces: **Chrome** Article Number: **42834000**



Spare part list

Year of production: >11/14

Pos.	Description	Article Number	PC	PU
1	tumbler on its own	92436000	0	1
2	support element	92458000	0	1
3	mounting set	92841000	0	1
4	excentric socket	97604000	0	1
5	cover	92427000	0	1
a	set of adapters	42870000	0	1