

STERLING

A KOHLER COMPANY

Custom Doors ORDER FORMS

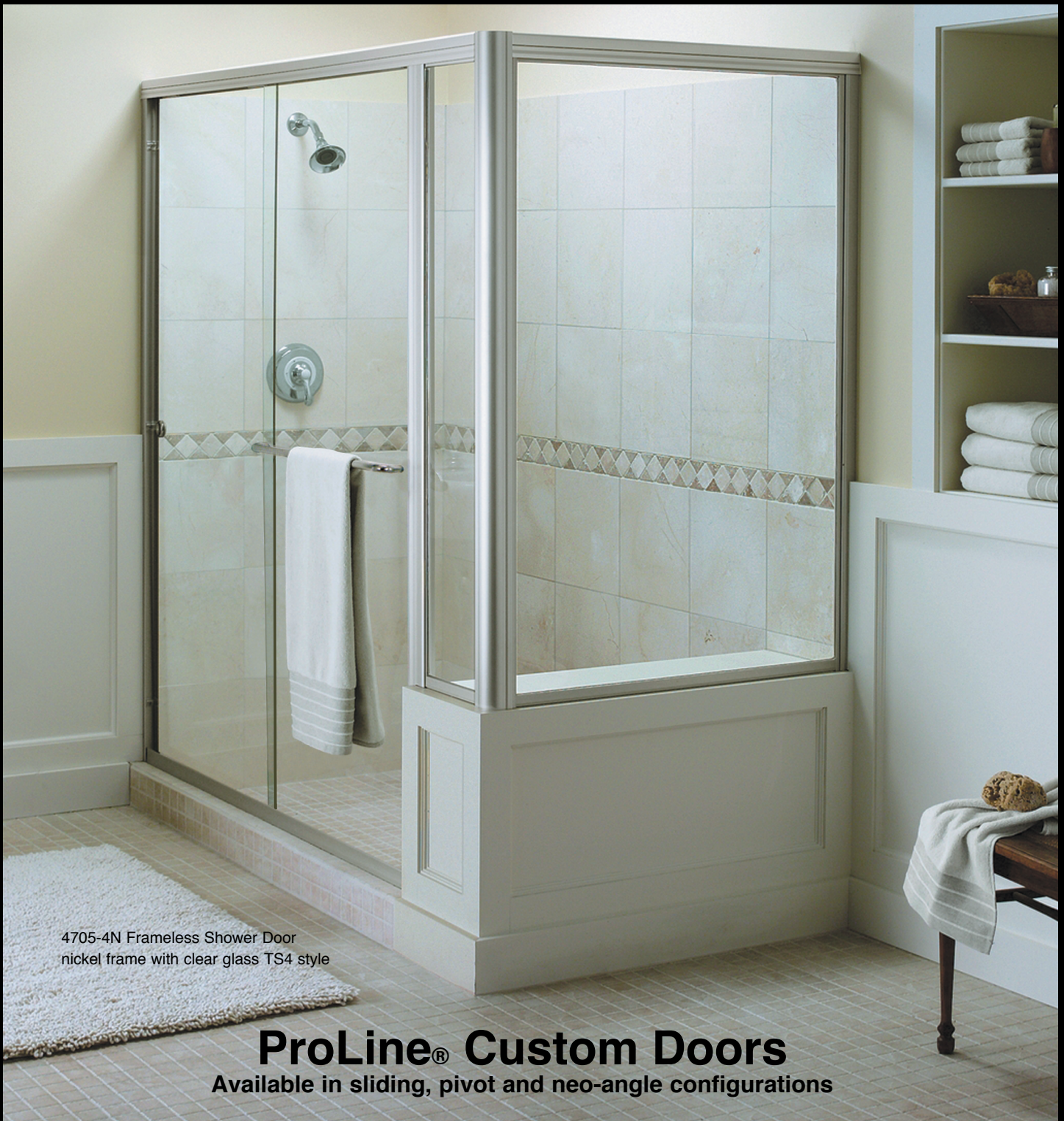

4705-4N Frameless Shower Door
nickel frame with clear glass TS4 style

ProLine® Custom Doors
Available in sliding, pivot and neo-angle configurations



ProLine® Custom Doors

Custom Door Index		Pages
Custom Pivot/Swing Shower Doors	Styles S1 thru S14	4-31
Custom Sliding Bath & Shower Doors	Styles TS1 thru TS9	32-49
Custom Neo Angle Shower Doors	Style N1 thru N5	50-59



1 Select either a bath or shower door.



Bath Door
For a bath or bath/shower combination.



Shower Door
For a unit designed exclusively for showering.

2 Determine your door size.

Step-by-Step Measurement Instructions

Correct measurements are critical.

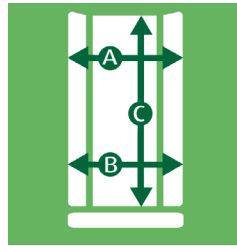
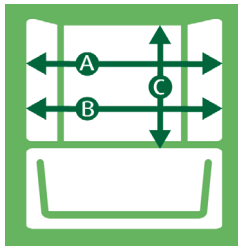

- Measure distance from wall to wall at both top and bottom of opening (A & B). These measurements may vary.
- Select door with maximum opening size equal to, or slightly **greater** than, your largest measurement.
- Measure distance from top of the bath ledge or shower base to top of the bath/shower, shower wall unit or tile wall where you want the door to be located (C).
- Select a door with desired height equal to, or slightly **less** than, your measurement.

IMPORTANT: When measuring the height (C), do not measure to the top of the bath/shower, shower unit or tile wall if there is a beveled or radius top edge. Keep the height measurement to the lowest starting point of the bevel or radius.

3 Choose a door type and frame option.



Sliding

Two overlapping glass panels that slide back and forth along a bottom track.



Pivot

This door swings out from the wall like a traditional door, even when walls are not parallel. Pivot doors provide the greatest range of adjustability.



Neo-Angle/Corner

These space-saving doors include fixed panels on either side of the door and are ideal for smaller bathrooms.



Framed

Aluminum frame mounted to the edges of the glass door panel adds structure to the glass.



Frameless

Minimal metal framing creates a sophisticated look and feel. Thicker glass is used to eliminate the need for structural framing.



4 Select a frame finish that complements your décor.

Available frame finishes will be listed on each door style. See following pages to order.

5 Select a glass texture that completes your space.



Clear



Pebbled

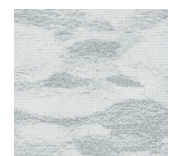

Hammered

STERLING® Custom Pivot/Swing Shower Doors

STERLING® PROLINE® FRAMED STYLE S1

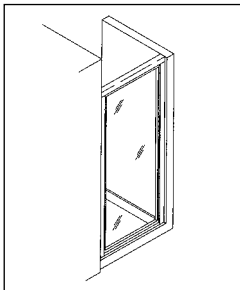

SPECIFICATIONS

PIVOT/SWING - 4800 SERIES - Style S1

Size: Door max. 36" width x 84" height

Features: Proline® pivot/swing framed door. Includes full length handle, no towel bar.

Glass Thickness: 3/16"

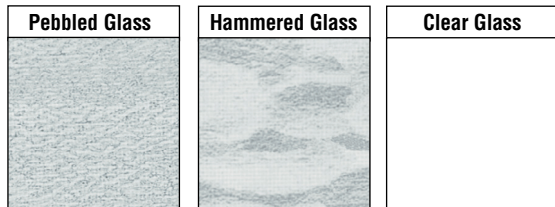
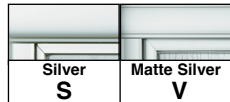

Model No.	Glass Pattern	Frame Finish			
		Silver	Matte Silver	Nickel	Deep Bronze
4800-1	Pebbled	\$651.25	\$725.60	N/A	N/A
4800-1	Hammered	\$651.25	\$725.60	N/A	N/A
4805-1	Clear	\$694.35	\$771.20	N/A	N/A

 **Custom Bath & Shower Doors.**
Allow 6 weeks for delivery. Custom doors not returnable.

STERLING® PROLINE® FRAMELESS STYLE S1

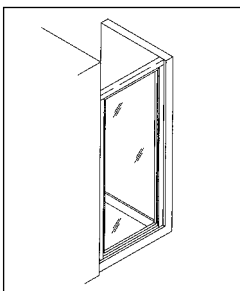

SPECIFICATIONS

PIVOT/SWING - 4900 SERIES - Style S1

Size: Door max. 36" width x 84" height

Features: Proline® pivot/swing door features frameless glass panel. Includes round single towel bar.

Glass Thickness: Frameless Doors with Clear are 1/4", all others 3/16"

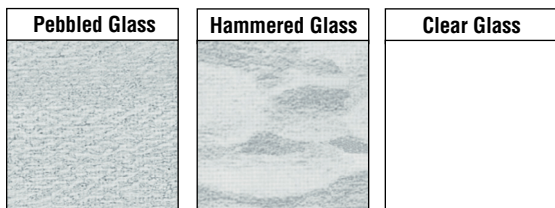
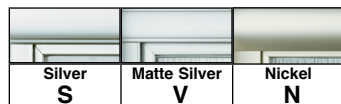

Model No.	Glass Pattern	Frame Finish			
		Silver	Matte Silver	Nickel	Deep Bronze
4900-1	Pebbled	\$777.75	\$857.80	\$835.15	N/A
4900-1	Hammered	\$777.75	\$857.80	\$835.15	N/A
4905-1	Clear	\$820.75	\$903.25	\$878.35	N/A

 **Custom Bath & Shower Doors.**
Allow 6 weeks for delivery. Custom doors not returnable.

NOTES:

CUSTOM MEASURING SHEETS ARE REQUIRED TO PROCESS ALL CUSTOM DOOR ORDERS. Measuring sheets must be faxed to 1-330-399-4426 Attn: Custom Shower Doors or email to: showerdoors@mdcnw.com

Custom door orders can not be processed without receipt of the form. Custom Doors are not returnable.

Notched Panels: Panels can be notched per the measuring sheet for a \$120.00 upcharge to the price.

Steam Units: Steam units are available for Framed ProLine Custom units only (4800 Series Models) at a \$75.00 upcharge to the price.

STERLING® Custom Pivot/Swing Shower Doors

CUSTOM PIVOT/SWING SHOWER DOOR MEASURING SHEET 4800 & 4900 SERIES

Sample Measuring Sheet

Style S1

Model # _____ (fill in from corresponding price page)

ECP Price \$ _____ P.O. # _____

Order Submitted By _____ Store # _____

Store Location _____

Number of Units Required _____

Delivery Address _____

(if different from above)

City _____ State _____ Zip _____

Your Customer Name _____

Your Customer's Phone No. _____

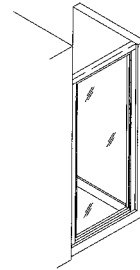

*Framed style shown.

Note: Glass panels are not the exact size of the opening. Allow for framing.

Step #1. Circle desired layout.

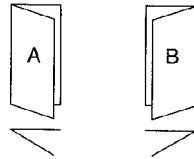

Step #2. Check door style

- Framed (4800 Series) Check here if you require a steam unit. (framed models only \$75.00 upcharge.)
- Frameless (4900 Series)
*For Frameless door style, only door panel(s) is/are frameless

Step #3. Check frame finish

- Silver Nickel (Frameless only)
- Matte Silver

Step #4. Check glass type desired:
(Please check one box only)



Pebbled

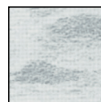

Hammered



Clear

Step #5. Measure installation area and fill in dimensions.

DIM L _____ DIM H _____
Door Width Height (from threshold up)

Door: max. 36" width, max. 84" height

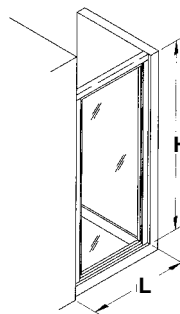

IMPORTANT: CUSTOM MEASURING SHEETS ARE REQUIRED TO PROCESS ALL CUSTOM DOOR ORDERS. Be sure to fill out completely and fax to 1-330-399-4426 attention Custom Shower Doors or email to showerdoors@mdcnw.com. Custom door orders can not be processed without receipt of the form. Custom doors are not returnable.

STERLING® Custom Pivot/Swing Shower Doors



PROLINE® FRAMED STYLE S2

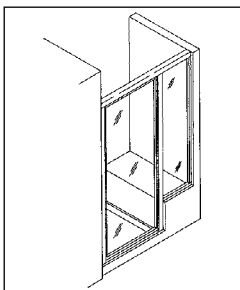

SPECIFICATIONS

PIVOT/SWING - 4800 SERIES - Style S2

Size: max. 60" total width x max. 84" height.

Door: max 36" width. Inline Panel: min. 6"/max. 24" width

Features: Proline® pivot/swing framed door with one inline panel on kneewall.

Includes full length handle, no towel bar.

Glass Thickness: 3/16"

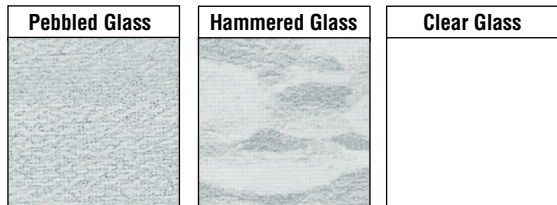
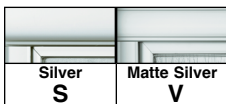

Model No.	Glass Pattern	Frame Finish			
		Silver	Matte Silver	Nickel	Deep Bronze
4800-2	Pebbled	\$873.45	\$957.15	N/A	N/A
4800-2	Hammered	\$873.45	\$957.15	N/A	N/A
4805-2	Clear	\$916.20	\$998.15	N/A	N/A

 **Custom Bath & Shower Doors.**
Allow 6 weeks for delivery. Custom doors not returnable.



PROLINE® FRAMELESS STYLE S1

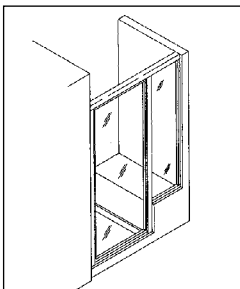

SPECIFICATIONS

PIVOT/SWING - 4900 SERIES - Style S2

Size: max. 60" total width x max. 84" height.

Door: max 36" width. Inline Panel: min. 6"/max. 24" width

Features: Proline® pivot/swing frameless glass panel door with one inline panel on kneewall.

Includes round single towel bar.

Glass Thickness: Frameless Doors with Clear glass are 1/4", all others 3/16"

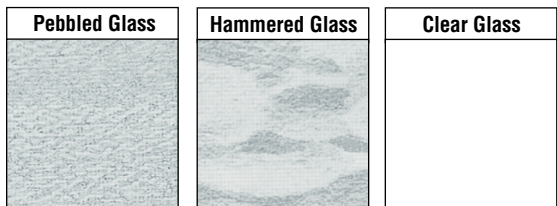

Model No.	Glass Pattern	Frame Finish			
		Silver	Matte Silver	Nickel	Deep Bronze
4900-2	Pebbled	\$999.50	\$1,089.25	\$1,057.30	N/A
4900-2	Hammered	\$999.50	\$1,089.25	\$1,057.30	N/A
4905-2	Clear	\$1,017.05	\$1,130.50	\$1,099.90	N/A

 **Custom Bath & Shower Doors.**
Allow 6 weeks for delivery. Custom doors not returnable.

NOTES:

CUSTOM MEASURING SHEETS ARE REQUIRED TO PROCESS ALL CUSTOM DOOR ORDERS. Measuring sheets must be faxed to 1-330-399-4426 Attn: Custom Shower Doors or email to: showerdoors@mdcnw.com

Custom door orders can not be processed without receipt of the form. Custom Doors are not returnable.

Notched Panels: Panels can be notched per the measuring sheet for a \$120.00 upcharge to the price.

Steam Units: Steam units are available for Framed ProLine Custom units only (4800 Series Models) at a \$75.00 upcharge to the price.

STERLING® Custom Pivot/Swing Shower Doors

CUSTOM PIVOT/SWING SHOWER DOOR MEASURING SHEET 4800 & 4900 SERIES

Sample Measuring Sheet

Style S2

Model # _____ (fill in from corresponding price page)

ECP Price \$ _____ P.O. # _____

Order Submitted By _____ Store # _____

Store Location _____

Number of Units Required _____

Delivery Address _____

(if different from above)

City _____ State _____ Zip _____

Your Customer Name _____

Your Customer's Phone No. _____

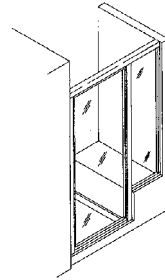

*Framed style shown.

Note: Glass panels are not the exact size of the opening. Allow for framing.

Step #1. Circle desired layout.

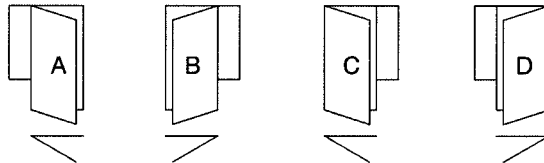

Step #2. Check door style

- Framed (4800 Series) Check here if you require a steam unit. (framed models only \$75.00 upcharge.)
- Frameless (4900 Series)
*For Frameless door style, only door panel(s) is/are frameless

Step #3. Check frame finish

- Silver Nickel (Frameless only)
- Matte Silver

Step #4. Check glass type desired:
(Please check one box only)

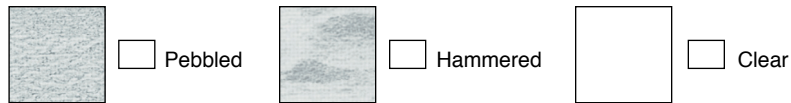

Step #5. Measure installation area and fill in dimensions.

DIM W _____ DIM R _____
Door Width Wall Height (from threshold up)

DIM S _____ DIM H _____
Inline Panel Width Height (from threshold up)
(6"min/24"max)

DIM L _____
Total Width (W+S)

Door: max. 36" width
Inline Panel: min. 6"/max. 24" width
Maximum 60" total width, max. 84" height

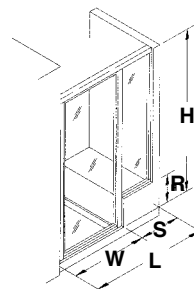

Step #6. If required, measure panel notches and fill in dimensions.

- N _____ P _____ Notched on Right
- O _____ Q _____ Notched on Left

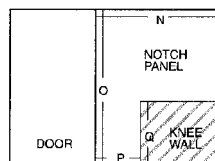

Note: Minimum notched panel dimensions = 4" x 4"
Notched panel must be at least 7" wide (measurement P) to prevent glass from breaking.

IMPORTANT: CUSTOM MEASURING SHEETS ARE REQUIRED TO PROCESS ALL CUSTOM DOOR ORDERS. Be sure to fill out completely and fax to 1-330-399-4426 attention Custom Shower Doors or email to showerdoors@mdcnw.com. Custom door orders can not be processed without receipt of the form. Custom doors are not returnable.

STERLING® Custom Pivot/Swing Shower Doors

STERLING® PROLINE® FRAMED STYLE S3

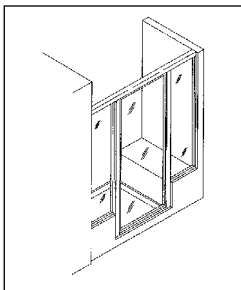

SPECIFICATIONS

PIVOT/SWING - 4800 SERIES - Style S3

Size: max. 84" total width x max. 84" height.

Door: max 36" width. Inline Panel: min. 6"/max. 24" width

Features: Proline® pivot/swing framed door with two inline panels on kneewall.

Includes full length handle, no towel bar.

Glass Thickness: 3/16"

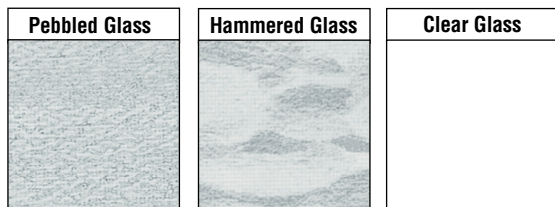
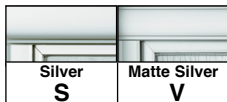

Model No.	Glass Pattern	Frame Finish			
		Silver	Matte Silver	Nickel	Deep Bronze
4800-3	Pebbled	\$1,198.70	\$1,297.55	N/A	N/A
4800-3	Hammered	\$1,198.70	\$1,297.55	N/A	N/A
4805-3	Clear	\$1,239.25	\$1,328.60	N/A	N/A

 **Custom Bath & Shower Doors.**
Allow 6 weeks for delivery. Custom doors not returnable.

STERLING® PROLINE® FRAMELESS STYLE S3

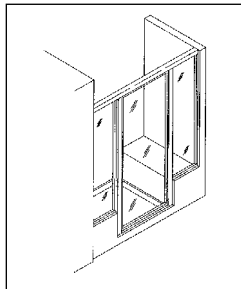

SPECIFICATIONS

PIVOT/SWING - 4900 SERIES - Style S3

Size: max. 84" total width x max. 84" height.

Door: max 36" width. Inline Panel: min. 6"/max. 24" width

Features: Proline® pivot/swing frameless glass panel door with two inline panels on kneewall.

Includes round single towel bar.

Glass Thickness: Frameless Doors with Clear glass are 1/4", all others 3/16"

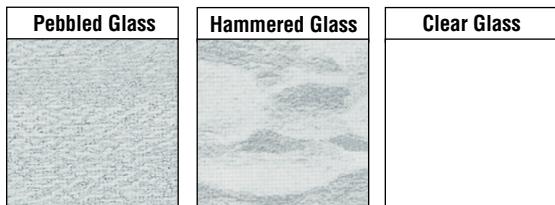

Model No.	Glass Pattern	Frame Finish			
		Silver	Matte Silver	Nickel	Deep Bronze
4900-3	Pebbled	\$1,325.10	\$1,428.50	\$1,382.20	N/A
4900-3	Hammered	\$1,325.10	\$1,428.50	\$1,382.20	N/A
4905-3	Clear	\$1,367.75	\$1,473.80	\$1,425.60	N/A

 **Custom Bath & Shower Doors.**
Allow 6 weeks for delivery. Custom doors not returnable.

NOTES:

CUSTOM MEASURING SHEETS ARE REQUIRED TO PROCESS ALL CUSTOM DOOR ORDERS. Measuring sheets must be faxed to 1-330-399-4426 Attn: Custom Shower Doors or email to: showerdoors@mdcnw.com

Custom door orders can not be processed without receipt of the form. Custom Doors are not returnable.

Notched Panels: Panels can be notched per the measuring sheet for a \$120.00 upcharge to the price.

Steam Units: Steam units are available for Framed ProLine Custom units only (4800 Series Models) at a \$75.00 upcharge to the price.

STERLING® Custom Pivot/Swing Shower Doors

CUSTOM PIVOT/SWING SHOWER DOOR MEASURING SHEET 4800 & 4900 SERIES

Sample Measuring Sheet

Style S3

Model # _____ (fill in from corresponding price page)

ECP Price \$ _____ P.O. # _____

Order Submitted By _____ Store # _____

Store Location _____

Number of Units Required _____

Delivery Address _____

(if different from above)

City _____ State _____ Zip _____

Your Customer Name _____

Your Customer's Phone No. _____

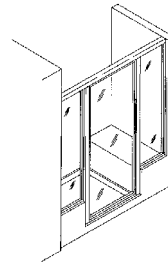

*Framed style shown.

Note: Glass panels are not the exact size of the opening. Allow for framing.

Step #1. Circle desired layout.

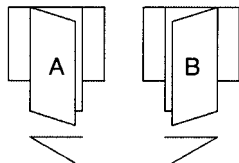

Step #2. Check door style

Framed (4800 Series) Check here if you require a steam unit. (framed models only \$75.00 upcharge.)

Frameless (4900 Series)
*For Frameless door style, only door panel(s) is/are frameless

Step #3. Check frame finish

Silver Nickel (Frameless only)

Matte Silver

Step #4. Check glass type desired:
(Please check one box only)



Pebbled

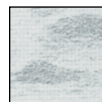

Hammered



Clear

Step #5. Measure installation area and fill in dimensions.

DIM W _____ DIM H _____
Door Width _____ Height (from threshold up)

DIM K _____ DIM T _____
Inline Panel Width (6"min/24"max) Wall Height (from threshold up)

DIM S _____ DIM R _____
Inline Panel Width (6"min/24"max) Wall Height (from threshold up)

DIM L _____
Total Width (W+K+S)

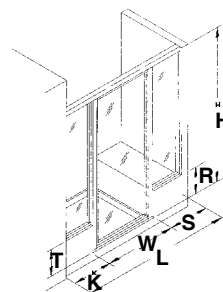

Door: max. 36" width

Inline Panel: min. 6"/max. 24" width

Max. 84" total width, max. 84" height

Step #6. If required, measure panel notches and fill in dimensions.

N _____ P _____ Notched on Right

O _____ Q _____ Notched on Left

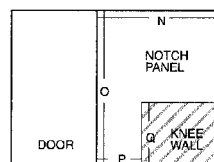

Note: Minimum notched panel dimensions = 4" x 4"
Notched panel must be at least 7" wide (measurement P) to prevent glass from breaking.

IMPORTANT: CUSTOM MEASURING SHEETS ARE REQUIRED TO PROCESS ALL CUSTOM DOOR ORDERS. Be sure to fill out completely and fax to 1-330-399-4426 attention Custom Shower Doors or email to showerdoors@mdcnw.com. Custom door orders can not be processed without receipt of the form. Custom doors are not returnable.

STERLING® Custom Pivot/Swing Shower Doors



PROLINE® FRAMED STYLE S4

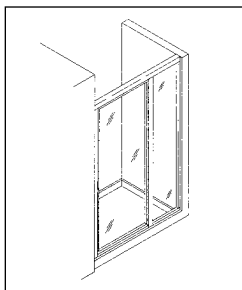

SPECIFICATIONS

PIVOT/SWING - 4800 SERIES - Style S4

Size: max. 60" total width x max. 84" height.

Door: max 36" width. Inline Panel: min. 6"/max. 24" width

Features: Proline® pivot/swing framed door with one floor length inline panel.

Includes full length handle, no towel bar.

Glass Thickness: 3/16"

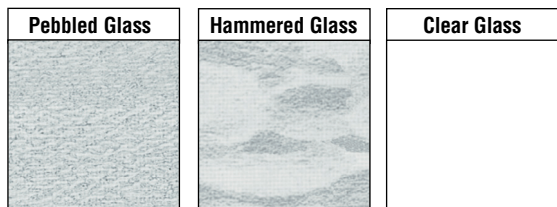
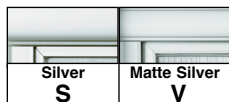

Model No.	Glass Pattern	Frame Finish			
		Silver	Matte Silver	Nickel	Deep Bronze
4800-4	Pebbled	\$913.60	\$998.15	N/A	N/A
4800-4	Hammered	\$913.60	\$998.15	N/A	N/A
4805-4	Clear	\$956.60	\$1,039.55	N/A	N/A

 **Custom Bath & Shower Doors.**
Allow 6 weeks for delivery. Custom doors not returnable.



PROLINE® FRAMELESS STYLE S4

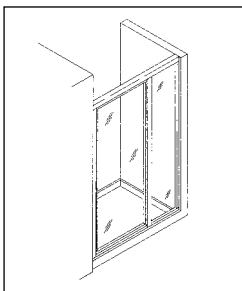

SPECIFICATIONS

PIVOT/SWING - 4900 SERIES - Style S4

Size: max. 60" total width x max. 84" height.

Door: max 36" width. Inline Panel: min. 6"/max. 24" width

Features: Proline® pivot/swing frameless glass panel door with one floor length inline panel.

Includes round single towel bar.

Glass Thickness: Frameless Doors with Clear glass are 1/4", all others 3/16"

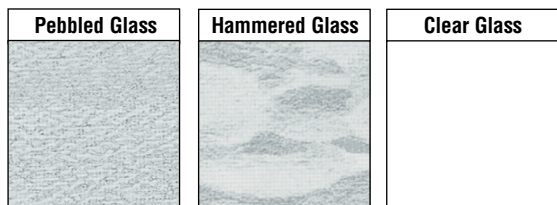
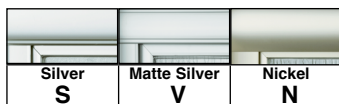

Model No.	Glass Pattern	Frame Finish			
		Silver	Matte Silver	Nickel	Deep Bronze
4900-4	Pebbled	\$1,039.55	\$1,126.30	\$1,097.35	N/A
4900-4	Hammered	\$1,039.55	\$1,126.30	\$1,097.35	N/A
4905-4	Clear	\$1,083.00	\$1,169.65	\$1,140.80	N/A

 **Custom Bath & Shower Doors.**
Allow 6 weeks for delivery. Custom doors not returnable.

NOTES:

CUSTOM MEASURING SHEETS ARE REQUIRED TO PROCESS ALL CUSTOM DOOR ORDERS. Measuring sheets must be faxed to 1-330-399-4426 Attn: Custom Shower Doors or email to: showerdoors@mdcnw.com

Custom door orders can not be processed without receipt of the form. Custom Doors are not returnable.

Notched Panels: Panels can be notched per the measuring sheet for a \$120.00 upcharge to the price.

Steam Units: Steam units are available for Framed ProLine Custom units only (4800 Series Models) at a \$75.00 upcharge to the price.

STERLING® Custom Pivot/Swing Shower Doors

CUSTOM PIVOT/SWING SHOWER DOOR MEASURING SHEET 4800 & 4900 SERIES

Sample Measuring Sheet

Style S4

Model # _____ (fill in from corresponding price page)

ECP Price \$ _____ P.O. # _____

Order Submitted By _____ Store # _____

Store Location _____

Number of Units Required _____

Delivery Address _____

(if different from above)

City _____ State _____ Zip _____

Your Customer Name _____

Your Customer's Phone No. _____

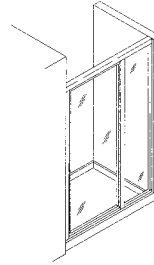

*Framed style shown.

Note: Glass panels are not the exact size of the opening. Allow for framing.

Step #1. Circle desired layout.

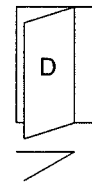
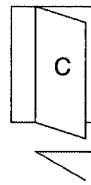
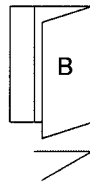

Step #2. Check door style

Framed
(4800 Series)

Check here if you require a steam unit.
(framed models only \$75.00 upcharge.)

Frameless (4900 Series)

*For Frameless door style, only door panel(s) is/are frameless

Step #3. Check frame finish

Silver

Nickel (Frameless only)

Matte Silver

Step #4. Check glass type desired:
(Please check one box only)

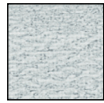

Pebbled

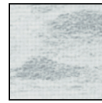

Hammered



Clear

Step #5. Measure installation area and fill in dimensions.

DIM W _____ DIM H _____
Door Width Height (from threshold up)

DIM S _____
Inline Panel Width (6"min/24"max)

DIM L _____
Total Width (W+S)

Door: max. 36" width
Inline Panel: min. 6"/max. 24" width
Maximum 60" total width, max. 84" height

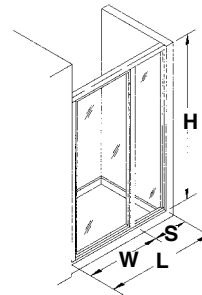

IMPORTANT: CUSTOM MEASURING SHEETS ARE REQUIRED TO PROCESS ALL CUSTOM DOOR ORDERS. Be sure to fill out completely and fax to 1-330-399-4426 attention Custom Shower Doors or email to showerdoors@mdcnw.com. Custom door orders can not be processed without receipt of the form. Custom doors are not returnable.

STERLING® Custom Pivot/Swing Shower Doors



PROLINE® FRAMED STYLE S5

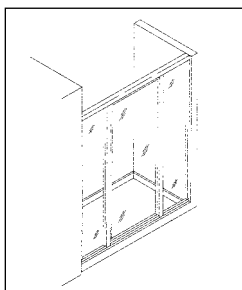

SPECIFICATIONS

PIVOT/SWING - 4800 SERIES - Style S5

Size: max. 84" total width x max. 84" height.

Door: max 36" width. Inline Panel: min. 6"/max. 24" width

Features: Proline® pivot/swing framed door with two floor length inline panels.

Includes full length handle, no towel bar.

Glass Thickness: 3/16"

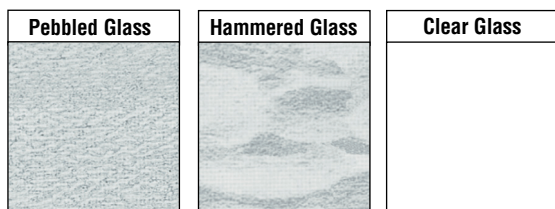
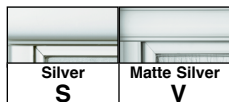

Model No.	Glass Pattern	Frame Finish			
		Silver	Matte Silver	Nickel	Deep Bronze
4800-5	Pebbled	\$1,239.25	\$1,328.60	N/A	N/A
4800-5	Hammered	\$1,239.25	\$1,328.60	N/A	N/A
4805-5	Clear	\$1,282.10	\$1,374.15	N/A	N/A

 **Custom Bath & Shower Doors.**
Allow 6 weeks for delivery. Custom doors not returnable.



PROLINE® FRAMELESS STYLE S5

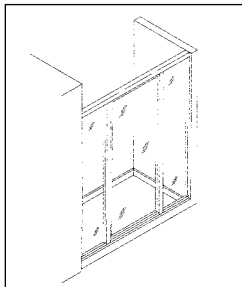

SPECIFICATIONS

PIVOT/SWING - 4900 SERIES - Style S5

Size: max. 84" total width x max. 84" height.

Door: max 36" width. Inline Panel: min. 6"/max. 24" width

Features: Proline® pivot/swing frameless glass panel door with two floor length inline panels.

Includes round single towel bar.

Glass Thickness: Frameless Doors with Clear glass are 1/4", all others 3/16"

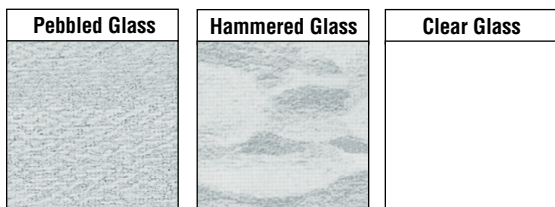

Model No.	Glass Pattern	Frame Finish			
		Silver	Matte Silver	Nickel	Deep Bronze
4900-5	Pebbled	\$1,364.95	\$1,470.90	\$1,423.00	N/A
4900-5	Hammered	\$1,364.95	\$1,470.90	\$1,423.00	N/A
4905-5	Clear	\$1,408.05	\$1,501.90	\$1,465.90	N/A

 **Custom Bath & Shower Doors.**
Allow 6 weeks for delivery. Custom doors not returnable.

NOTES:

CUSTOM MEASURING SHEETS ARE REQUIRED TO PROCESS ALL CUSTOM DOOR ORDERS. Measuring sheets must be faxed to 1-330-399-4426 Attn: Custom Shower Doors or email to: showerdoors@mdcnow.com

Custom door orders can not be processed without receipt of the form. Custom Doors are not returnable.

Notched Panels: Panels can be notched per the measuring sheet for a \$120.00 upcharge to the price.

Steam Units: Steam units are available for Framed ProLine Custom units only (4800 Series Models) at a \$75.00 upcharge to the price.

STERLING® Custom Pivot/Swing Shower Doors

CUSTOM PIVOT/SWING SHOWER DOOR MEASURING SHEET 4800 & 4900 SERIES

Sample Measuring Sheet

Style S5

Model # _____ (fill in from corresponding price page)

ECP Price \$ _____ P.O. # _____

Order Submitted By _____ Store # _____

Store Location _____

Number of Units Required _____

Delivery Address _____

(if different from above)

City _____ State _____ Zip _____

Your Customer Name _____

Your Customer's Phone No. _____

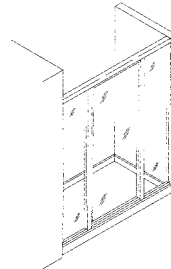

*Framed style shown.

Note: Glass panels are not the exact size of the opening. Allow for framing.

Step #1. Circle desired layout.

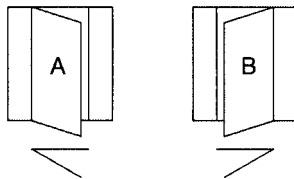

Step #2. Check door style

Framed (4800 Series) Check here if you require a steam unit. (framed models only \$75.00 upcharge.)

Frameless (4900 Series)
*For Frameless door style, only door panel(s) is/are frameless

Step #3. Check frame finish

Silver Nickel (Frameless only)
 Matte Silver

Step #4. Check glass type desired:

(Please check one box only)



Pebbled

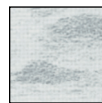

Hammered



Clear

Step #5. Measure installation area and fill in dimensions.

DIM W _____ DIM H _____
Door Width Height (from threshold up)

DIM K _____
Inline Panel Width (6"min/24"max)

DIM S _____
Inline Panel Width (6"min/24"max)

DIM L _____
Total Width (W+K+S)

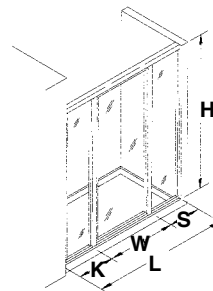

Door: max. 36" width

Inline Panel: min. 6"/max. 24" width

Max. 84" total width, max. 84" height

IMPORTANT: CUSTOM MEASURING SHEETS ARE REQUIRED TO PROCESS ALL CUSTOM DOOR ORDERS. Be sure to fill out completely and fax to 1-330-399-4426 attention Custom Shower Doors or email to showerdoors@mdcnw.com. Custom door orders can not be processed without receipt of the form. Custom doors are not returnable.

STERLING® Custom Pivot/Swing Shower Doors

STERLING® KOHLER COMPANY PROLINE® FRAMED STYLE S6

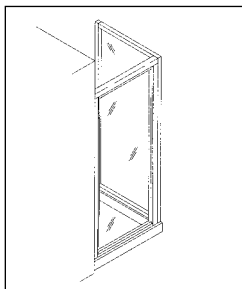

SPECIFICATIONS

PIVOT/SWING - 4800 SERIES - Style S6

Size: max. 84" height.

Door: max 36" width. Return Panel: min. 6"/max. 48" width

Features: Proline® pivot/swing framed door with one floor length return panel.

Includes full length handle, no towel bar.

Glass Thickness: 3/16"

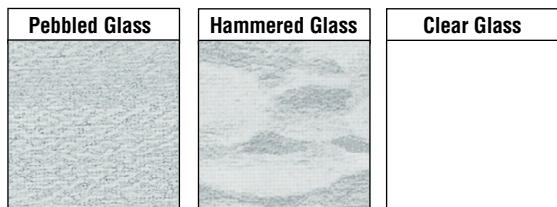
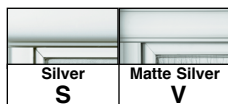

Model No.	Glass Pattern	Frame Finish			
		Silver	Matte Silver	Nickel	Deep Bronze
4800-6	Pebbled	\$1,329.80	\$1,460.95	N/A	N/A
4800-6	Hammered	\$1,329.80	\$1,460.95	N/A	N/A
4805-6	Clear	\$1,369.95	\$1,432.65	N/A	N/A

 **Custom Bath & Shower Doors.**
Allow 6 weeks for delivery. Custom doors not returnable.

STERLING® KOHLER COMPANY PROLINE® FRAMELESS STYLE S6

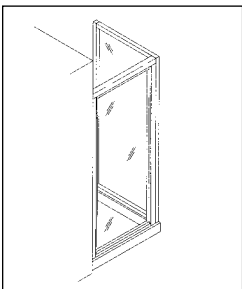

SPECIFICATIONS

PIVOT/SWING - 4900 SERIES - Style S6

Size: max. 84" height.

Door: max 36" width. Return Panel: min. 6"/max. 48" width

Features: Proline® pivot/swing frameless glass panel door with one floor length return panel.

Includes round single towel bar.

Glass Thickness: Frameless Doors with Clear glass are 1/4", all others 3/16"

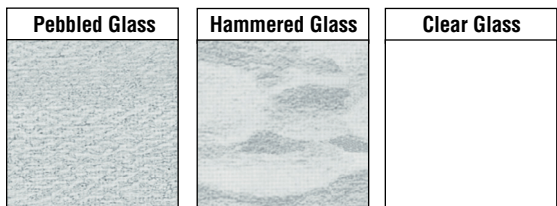
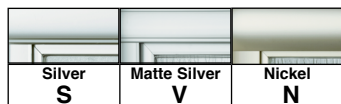

Model No.	Glass Pattern	Frame Finish			
		Silver	Matte Silver	Nickel	Deep Bronze
4900-6	Pebbled	\$1,453.45	\$1,460.95	\$1,511.40	N/A
4900-6	Hammered	\$1,453.45	\$1,460.95	\$1,511.40	N/A
4905-6	Clear	\$1,495.90	\$1,597.25	\$1,553.85	N/A

 **Custom Bath & Shower Doors.**
Allow 6 weeks for delivery. Custom doors not returnable.

NOTES:

CUSTOM MEASURING SHEETS ARE REQUIRED TO PROCESS ALL CUSTOM DOOR ORDERS. Measuring sheets must be faxed to 1-330-399-4426 Attn: Custom Shower Doors or email to: showerdoors@mdcnw.com

Custom door orders can not be processed without receipt of the form. Custom Doors are not returnable.

Notched Panels: Panels can be notched per the measuring sheet for a \$120.00 upcharge to the price.

Steam Units: Steam units are available for Framed ProLine Custom units only (4800 Series Models) at a \$75.00 upcharge to the price.

STERLING® Custom Pivot/Swing Shower Doors

CUSTOM PIVOT/SWING SHOWER DOOR MEASURING SHEET 4800 & 4900 SERIES

Sample Measuring Sheet

Style S6

Model # _____ (fill in from corresponding price page)

ECP Price \$ _____ P.O. # _____

Order Submitted By _____ Store # _____

Store Location _____

Number of Units Required _____

Delivery Address _____
(if different from above)

City _____ State _____ Zip _____

Your Customer Name _____

Your Customer's Phone No. _____

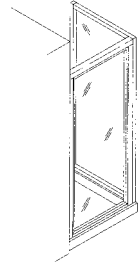

*Framed style shown.

Note: Glass panels are not the exact size of the opening. Allow for framing.

Step #1. Circle desired lay-out.

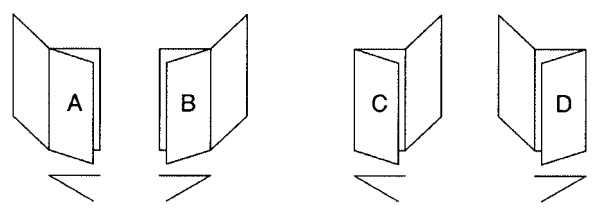

Step #2. Check door style

- Framed (4800 Series)
- Check here if you require a steam unit. (framed models only \$75.00 upcharge.)
- Frameless (4900 Series)
- *For Frameless door style, only door panel(s) is/are frameless*

Step #3. Check frame finish

- Silver
- Nickel (Frameless only)
- Matte Silver

Step #4. Check glass type desired:
(Please check one box only)

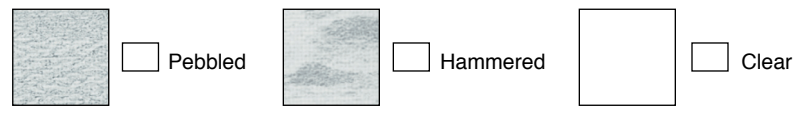

Step #5. Measure installation area and fill in dimensions.

DIM L _____ DIM H _____
Door Width Height (from threshold up)

DIM E _____
Return Panel Width (6"min/48"max)

Door: max. 36" width
Return Panel: min. 6"/max. 48" width
Maximum 84" height

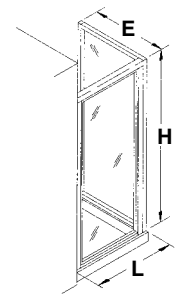

IMPORTANT: CUSTOM MEASURING SHEETS ARE REQUIRED TO PROCESS ALL CUSTOM DOOR ORDERS. Be sure to fill out completely and fax to 1-330-399-4426 attention Custom Shower Doors or email to showerdoors@mdcnw.com. Custom door orders can not be processed without receipt of the form. Custom doors are not returnable.

STERLING® Custom Pivot/Swing Shower Doors

STERLING® PROLINE® FRAMED STYLE S7

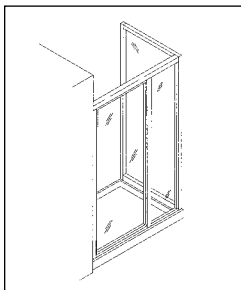

SPECIFICATIONS

PIVOT/SWING - 4800 SERIES - Style S7

Size: max. 60" total width x 84" height. Door: max 36" width.

Inline Panel: min. 6"/max. 24" width. Return Panel: min. 6"/max. 48" width

Features: Proline® pivot/swing framed door with one floor length inline panel and one floor length return panel. Includes full length handle, no towel bar.

Glass Thickness: 3/16"

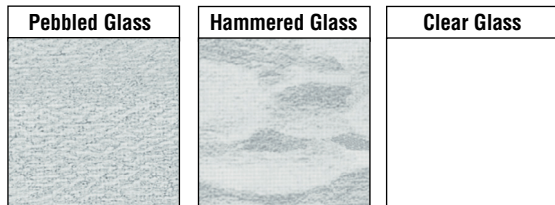
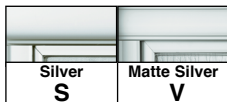

Model No.	Glass Pattern	Frame Finish			
		Silver	Matte Silver	Nickel	Deep Bronze
4800-7	Pebbled	\$1,597.25	\$1,692.25	N/A	N/A
4800-7	Hammered	\$1,597.25	\$1,692.25	N/A	N/A
4805-7	Clear	\$1,640.45	\$1,733.45	N/A	N/A

 **Custom Bath & Shower Doors.**
Allow 6 weeks for delivery. Custom doors not returnable.

STERLING® PROLINE® FRAMELESS STYLE S7

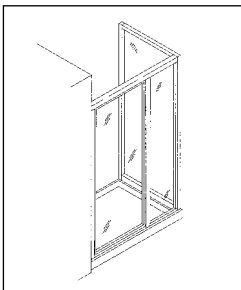

SPECIFICATIONS

PIVOT/SWING - 4900 SERIES - Style S7

Size: max. 60" total width x 84" height. Door: max 36" width.

Inline Panel: min. 6"/max. 24" width. Return Panel: min. 6"/max. 48" width

Features: Proline® pivot/swing frameless glass panel door with one floor length inline panel and one floor length return panel. Includes round single towel bar.

Glass Thickness: Frameless Doors with Clear glass are 1/4", all others 3/16"

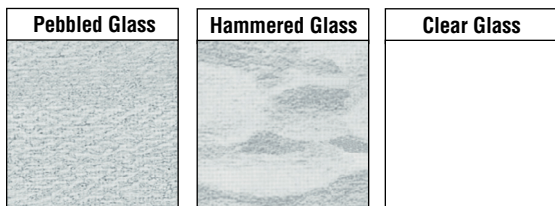

Model No.	Glass Pattern	Frame Finish			
		Silver	Matte Silver	Nickel	Deep Bronze
4900-7	Pebbled	\$1,597.25	\$1,816.15	\$1,785.30	N/A
4900-7	Hammered	\$1,597.25	\$1,816.15	\$1,785.30	N/A
4905-7	Clear	\$1,763.40	\$1,869.85	\$1,822.30	N/A

 **Custom Bath & Shower Doors.**
Allow 6 weeks for delivery. Custom doors not returnable.

NOTES:

CUSTOM MEASURING SHEETS ARE REQUIRED TO PROCESS ALL CUSTOM DOOR ORDERS. Measuring sheets must be faxed to 1-330-399-4426 Attn: Custom Shower Doors or email to: showerdoors@mdcnow.com

Custom door orders can not be processed without receipt of the form. Custom Doors are not returnable.

Notched Panels: Panels can be notched per the measuring sheet for a \$120.00 upcharge to the price.

Steam Units: Steam units are available for Framed ProLine Custom units only (4800 Series Models) at a \$75.00 upcharge to the price.

STERLING® Custom Pivot/Swing Shower Doors

CUSTOM PIVOT/SWING SHOWER DOOR MEASURING SHEET 4800 & 4900 SERIES

Sample Measuring Sheet

Style S7

Model # _____ (fill in from corresponding price page)

ECP Price \$ _____ P.O. # _____

Order Submitted By _____ Store # _____

Store Location _____

Number of Units Required _____

Delivery Address _____

(if different from above)

City _____ State _____ Zip _____

Your Customer Name _____

Your Customer's Phone No. _____

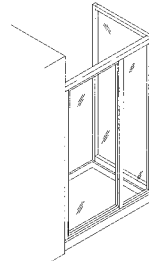

*Framed style shown.

Note: Glass panels are not the exact size of the opening. Allow for framing.

Step #1. Circle desired layout.

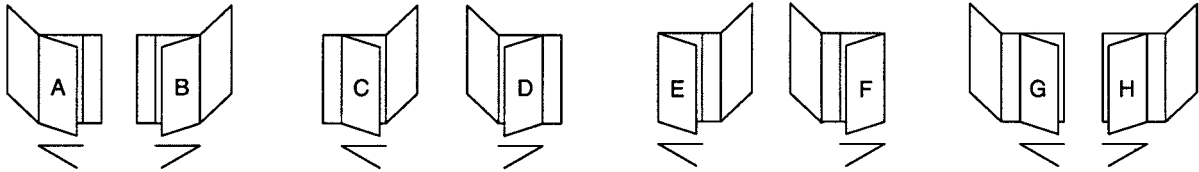

Step #2. Check door style

- Framed (4800 Series) Check here if you require a steam unit. (framed models only \$75.00 upcharge.)
- Frameless (4900 Series)
*For Frameless door style, only door panel(s) is/are frameless

Step #3. Check frame finish

- Silver Nickel (Frameless only)
- Matte Silver

Step #4. Check glass type desired:
(Please check one box only)

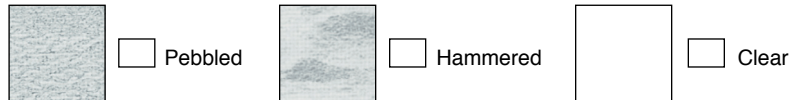

Step #5. Measure installation area and fill in dimensions.

DIM W _____ DIM H _____
Door Width Height (from threshold up)

DIM S _____ DIM E _____
Inline Panel Width (6"min/24"max) Return Panel Width (6"min/48"max)

DIM L _____
Total Width (W+S)

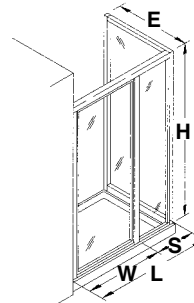

Door: max. 36" width
Inline Panel: min. 6"/max. 24" width
Return Panel: min. 6"/max. 48" width
Max. 60" total width, max. 84" height

IMPORTANT: CUSTOM MEASURING SHEETS ARE REQUIRED TO PROCESS ALL CUSTOM DOOR ORDERS. Be sure to fill out completely and fax to 1-330-399-4426 attention Custom Shower Doors or email to showerdoors@mdcnw.com. Custom door orders can not be processed without receipt of the form. Custom doors are not returnable.

STERLING® Custom Pivot/Swing Shower Doors

STERLING® PROLINE® FRAMED STYLE S8

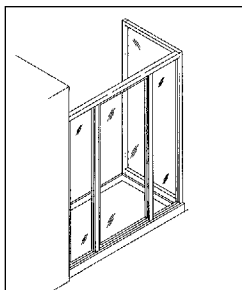

SPECIFICATIONS

PIVOT/SWING - 4800 SERIES - Style S8

Size: max. 84" total width x max. 84" height.

Door: max 36" width.

Inline Panel: min. 6"/max. 24" width. Return Panel: min. 6"/max. 48" width

Features: Proline® pivot/swing framed door with two floor length inline panels and one floor length return panel. Includes full length handle, no towel bar.

Glass Thickness: 3/16"

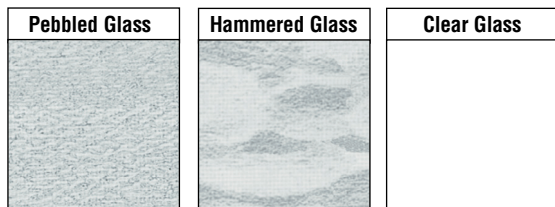
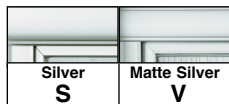

Model No.	Glass Pattern	Frame Finish			
		Silver	Matte Silver	Nickel	Deep Bronze
4800-8	Pebbled	\$1,897.15	\$2,024.85	N/A	N/A
4800-8	Hammered	\$1,897.15	\$2,024.85	N/A	N/A
4805-8	Clear	\$1,940.15	\$2,069.70	N/A	N/A

Custom Bath & Shower Doors.
Allow 6 weeks for delivery. Custom doors not returnable.

STERLING® PROLINE® FRAMELESS STYLE S8

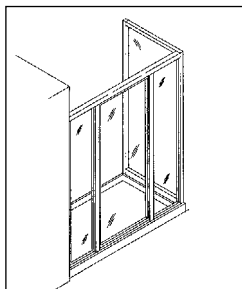

SPECIFICATIONS

PIVOT/SWING - 4900 SERIES - Style S8

Size: max. 84" total width x max. 84" height. Door: max 36" width.

Inline Panel: min. 6"/max. 24" width. Return Panel: min. 6"/max. 48" width

Features: Proline® pivot/swing frameless glass panel door with two floor length inline panels and one floor length return panel. Includes round single towel bar.

Glass Thickness: Frameless Doors with Clear glass are 1/4", all others 3/16"

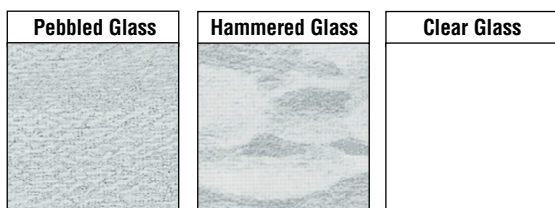
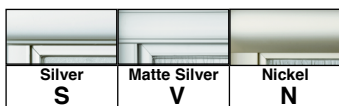

Model No.	Glass Pattern	Frame Finish			
		Silver	Matte Silver	Nickel	Deep Bronze
4900-8	Pebbled	\$2,018.40	\$2,150.40	\$2,075.80	N/A
4900-8	Hammered	\$2,018.40	\$2,150.40	\$2,075.80	N/A
4905-8	Clear	\$2,061.15	\$2,191.90	\$2,200.20	N/A

Custom Bath & Shower Doors.
Allow 6 weeks for delivery. Custom doors not returnable.

NOTES:

CUSTOM MEASURING SHEETS ARE REQUIRED TO PROCESS ALL CUSTOM DOOR ORDERS. Measuring sheets must be faxed to 1-330-399-4426 Attn: Custom Shower Doors or email to: showerdoors@mdcnw.com

Custom door orders can not be processed without receipt of the form. Custom Doors are not returnable.

Notched Panels: Panels can be notched per the measuring sheet for a \$120.00 upcharge to the price.

Steam Units: Steam units are available for Framed ProLine Custom units only (4800 Series Models) at a \$75.00 upcharge to the price.

STERLING® Custom Pivot/Swing Shower Doors

CUSTOM PIVOT/SWING SHOWER DOOR MEASURING SHEET 4800 & 4900 SERIES

Sample Measuring Sheet

Style S8

Model # _____ (fill in from corresponding price page)

ECP Price \$ _____ P.O. # _____

Order Submitted By _____ Store # _____

Store Location _____

Number of Units Required _____

Delivery Address _____

(if different from above)

City _____ State _____ Zip _____

Your Customer Name _____

Your Customer's Phone No. _____

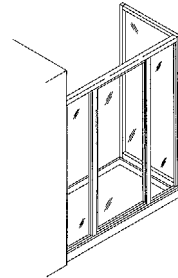

*Framed style shown.

Note: Glass panels are not the exact size of the opening. Allow for framing.

Step #1. Circle desired layout.

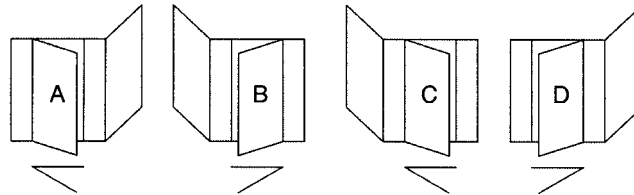

Step #2. Check door style

- Framed (4800 Series) Check here if you require a steam unit. (framed models only \$75.00 upcharge.)
- Frameless (4900 Series)
*For Frameless door style, only door panel(s) is/are frameless

Step #3. Check frame finish

- Silver Nickel (Frameless only)
- Matte Silver

Step #4. Check glass type desired: (Please check one box only)



Pebbled

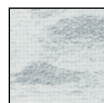

Hammered

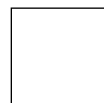

Clear

Step #5. Measure installation area and fill in dimensions.

DIM W _____
Door Width

DIM E _____
Return Panel Width (6"min/48"max)

DIM K _____
Inline Panel Width (6"min/24"max)

DIM H _____
Height (from threshold up)

DIM S _____
Inline Panel Width (6"min/24"max)

DIM L _____
Total Width (W+K+S)

Door: max. 36" width
Inline Panel: min. 6"/max. 24" width
Return Panel: min. 6"/max. 48" width
Max. 84" total width, max. 84" height

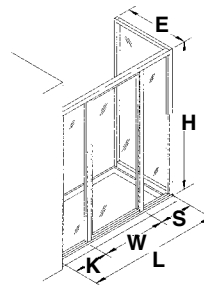

IMPORTANT: CUSTOM MEASURING SHEETS ARE REQUIRED TO PROCESS ALL CUSTOM DOOR ORDERS. Be sure to fill out completely and fax to 1-330-399-4426 attention Custom Shower Doors or email to showerdoors@mdcnw.com. Custom door orders can not be processed without receipt of the form. Custom doors are not returnable.

STERLING® Custom Pivot/Swing Shower Doors

STERLING® PROLINE® FRAMED STYLE S9

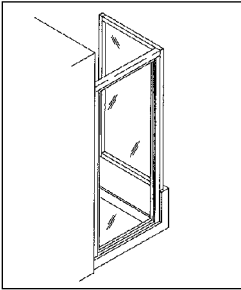

SPECIFICATIONS

PIVOT/SWING - 4800 SERIES - Style S9

Size: max. 84" height.

Door: max 36" width. Return Panel: min. 6"/max. 48" width

Features: Proline® pivot/swing framed door with one return panel on kneewall.

Includes full length handle, no towel bar.

Glass Thickness: 3/16"

Silver S	Matte Silver V	Pol Brass PB	White W

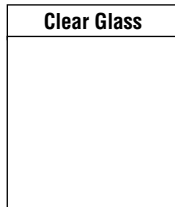
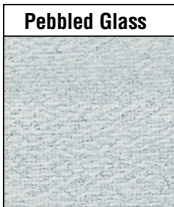

Model No.	Glass Pattern	Frame Finish			
		Silver	Matte Silver	Nickel	Deep Bronze
4800-9	Pebbled	\$1,294.55	\$1,386.45	N/A	N/A
4800-9	Hammered	\$1,294.55	\$1,386.45	N/A	N/A
4805-9	Clear	\$1,335.00	\$1,427.65	N/A	N/A

Custom Bath & Shower Doors.
Allow 6 weeks for delivery. Custom doors not returnable.

STERLING® PROLINE® FRAMELESS STYLE S9

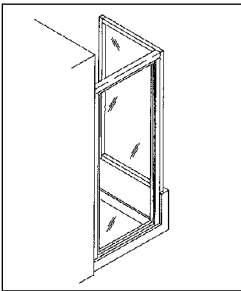

SPECIFICATIONS

PIVOT/SWING - 4900 SERIES - Style S9

Size: max. 84" height.

Door: max 36" width. Return Panel: min. 6"/max. 48" width

Features: Proline® pivot/swing frameless glass panel door with one return panel on kneewall.

Includes round single towel bar.

Glass Thickness: Frameless Doors with Clear glass are 1/4", all others 3/16"

Silver S	Matte Silver V	Nickel N

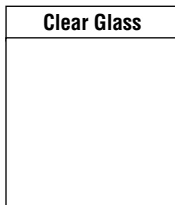
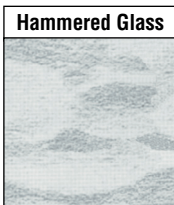
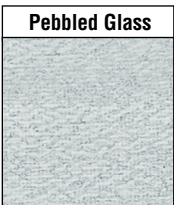

Model No.	Glass Pattern	Frame Finish			
		Silver	Matte Silver	Nickel	Deep Bronze
4900-9	Pebbled	\$1,420.50	\$1,528.65	\$1,478.25	N/A
4900-9	Hammered	\$1,420.50	\$1,528.65	\$1,478.25	N/A
4905-9	Clear	\$1,460.95	\$1,568.35	\$1,518.75	N/A

Custom Bath & Shower Doors.
Allow 6 weeks for delivery. Custom doors not returnable.

NOTES:

CUSTOM MEASURING SHEETS ARE REQUIRED TO PROCESS ALL CUSTOM DOOR ORDERS. Measuring sheets must be faxed to 1-330-399-4426 Attn: Custom Shower Doors or email to: showerdoors@mdcnw.com

Custom door orders can not be processed without receipt of the form. Custom Doors are not returnable.

Notched Panels: Panels can be notched per the measuring sheet for a \$120.00 upcharge to the price.

Steam Units: Steam units are available for Framed ProLine Custom units only (4800 Series Models) at a \$75.00 upcharge to the price.

STERLING® Custom Pivot/Swing Shower Doors

CUSTOM PIVOT/SWING SHOWER DOOR MEASURING SHEET 4800 & 4900 SERIES

Sample Measuring Sheet

Style S9

Model # _____ (fill in from corresponding price page)
 ECP Price \$ _____ P.O. # _____
 Order Submitted By _____ Store # _____
 Store Location _____
 Number of Units Required _____
 Delivery Address _____
 (if different from above)
 City _____ State _____ Zip _____
 Your Customer Name _____
 Your Customer's Phone No. _____

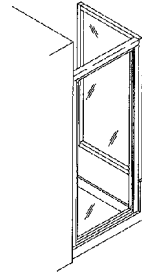

*Framed style shown.

Note: Glass panels are not the exact size of the opening. Allow for framing.

Step #1. Circle desired layout.

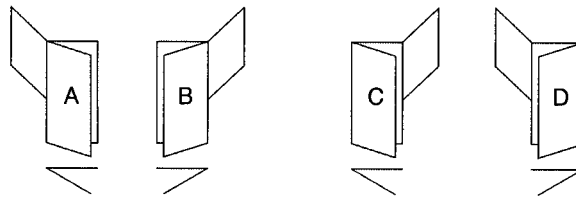



Step #2. Check door style

Framed (4800 Series) Check here if you require a steam unit. (framed models only \$75.00 upcharge.)
 Frameless (4900 Series)
**For Frameless door style, only door panel(s) is/are frameless*

Step #3. Check frame finish

Silver Nickel (Frameless only)
 Matte Silver

Step #4. Check glass type desired:
 (Please check one box only)

 Pebbled  Hammered  Clear

Step #5. Measure installation area and fill in dimensions.

DIM L _____ DIM H _____
 Door Width Height (from threshold up)
 DIM E _____ DIM R _____
 Return Panel Width (6"min/48"max) Wall Height (from threshold up)

Door: max. 36" width
Return Panel: min. 6"/max. 48" width
Maximum 84" height

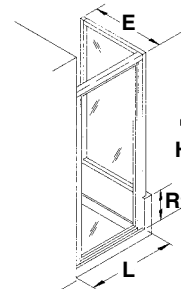

IMPORTANT: CUSTOM MEASURING SHEETS ARE REQUIRED TO PROCESS ALL CUSTOM DOOR ORDERS. Be sure to fill out completely and fax to 1-330-399-4426 attention Custom Shower Doors or email to showerdoors@mdcnw.com. Custom door orders can not be processed without receipt of the form. Custom doors are not returnable.

STERLING® Custom Pivot/Swing Shower Doors



PROLINE® FRAMED STYLE S10

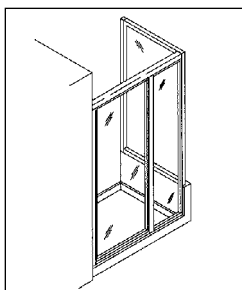

SPECIFICATIONS

PIVOT/SWING - 4800 SERIES - Style S10

Size: max. 60" total width x 84" height. Door: max 36" width.

Inline Panel: min. 6"/max. 24" width. Return Panel: min. 6"/max. 48" width

Features: Proline® pivot/swing framed door with one inline panel and one return panel on kneewall.

Includes full length handle, no towel bar.

Glass Thickness: 3/16"

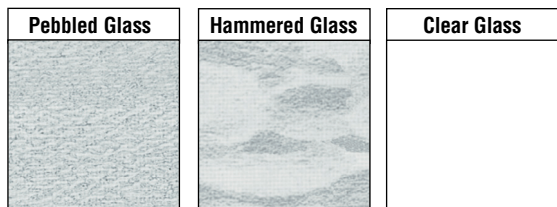
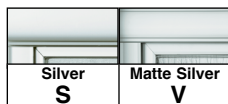

Model No.	Glass Pattern	Frame Finish			
		Silver	Matte Silver	Nickel	Deep Bronze
4800-10	Pebbled	\$1,524.05	\$1,609.55	N/A	N/A
4800-10	Hammered	\$1,524.05	\$1,609.55	N/A	N/A
4805-10	Clear	\$1,567.10	\$1,650.85	N/A	N/A

 **Custom Bath & Shower Doors.**
Allow 6 weeks for delivery. Custom doors not returnable.



PROLINE® FRAMELESS STYLE S10

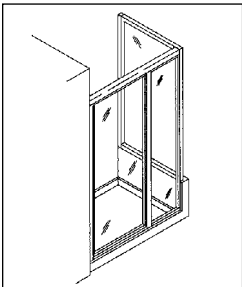

SPECIFICATIONS

PIVOT/SWING - 4900 SERIES - Style S10

Size: max. 60" total width x 84" height. Door: max 36" width.

Inline Panel: min. 6"/max. 24" width. Return Panel: min. 6"/max. 48" width

Features: Proline® pivot/swing frameless glass panel door with one inline panel and one return panel on kneewall. Includes round single towel bar.

Glass Thickness: Frameless Doors with Clear glass are 1/4", all others 3/16"

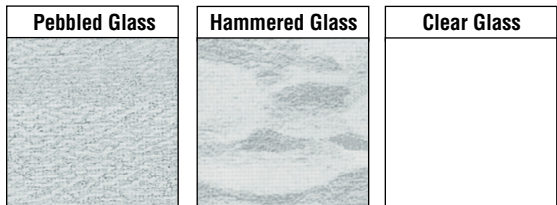

Model No.	Glass Pattern	Frame Finish			
		Silver	Matte Silver	Nickel	Deep Bronze
4900-10	Pebbled	\$1,647.45	\$1,764.40	\$1,705.70	N/A
4900-10	Hammered	\$1,647.45	\$1,764.40	\$1,705.70	N/A
4905-10	Clear	\$1,690.00	\$1,795.40	\$1,737.60	N/A

 **Custom Bath & Shower Doors.**
Allow 6 weeks for delivery. Custom doors not returnable.

NOTES:

CUSTOM MEASURING SHEETS ARE REQUIRED TO PROCESS ALL CUSTOM DOOR ORDERS. Measuring sheets must be faxed to 1-330-399-4426 Attn: Custom Shower Doors or email to: showerdoors@mdcnw.com

Custom door orders can not be processed without receipt of the form. Custom Doors are not returnable.

Notched Panels: Panels can be notched per the measuring sheet for a \$120.00 upcharge to the price.

Steam Units: Steam units are available for Framed ProLine Custom units only (4800 Series Models) at a \$75.00 upcharge to the price.

STERLING® Custom Pivot/Swing Shower Doors

CUSTOM PIVOT/SWING SHOWER DOOR MEASURING SHEET 4800 & 4900 SERIES

Sample Measuring Sheet

Style S10

Model # _____ (fill in from corresponding price page)

ECP Price \$ _____ P.O. # _____

Order Submitted By _____ Store # _____

Store Location _____

Number of Units Required _____

Delivery Address _____

(if different from above)

City _____ State _____ Zip _____

Your Customer Name _____

Your Customer's Phone No. _____

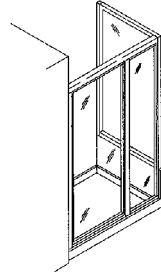

*Framed style shown.

Note: Glass panels are not the exact size of the opening. Allow for framing.

Step #1. Circle desired layout.

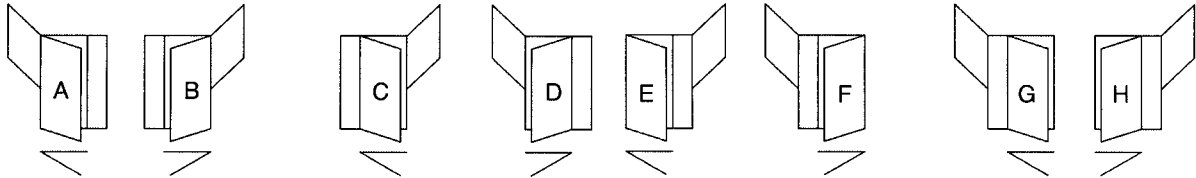

Step #2. Check door style

- Framed (4800 Series) Check here if you require a steam unit. (framed models only \$75.00 upcharge.)
- Frameless (4900 Series)
*For Frameless door style, only door panel(s) is/are frameless

Step #3. Check frame finish

- Silver Nickel (Frameless only)
- Matte Silver

Step #4. Check glass type desired:
(Please check one box only)

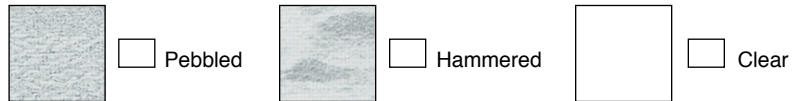

Step #5. Measure installation area and fill in dimensions.

- DIM W _____ Door Width
- DIM E _____ Return Panel Width (6"min/48"max)
- DIM S _____ Inline Panel Width (6"min/24"max)
- DIM R _____ Wall Height (from threshold up)
- DIM L _____ Total Width (W+S)
- DIM H _____ Height (from threshold up)

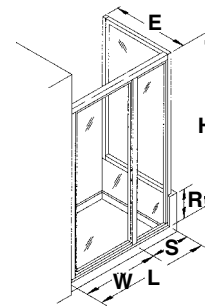

Door: max. 36" width
Inline Panel: min. 6"/max. 24" width
Return Panel: min. 6"/max. 48" width
Max. 60" total width, max. 84" height

Step #6. If required, measure panel notches and fill in dimensions.

- N _____ P _____ Notched on Right
- O _____ Q _____ Notched on Left

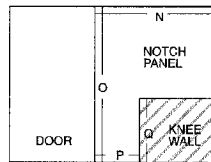

Note: Minimum notched panel dimensions = 4" x 4"
 Notched panel must be at least 7" wide (measurement P) to prevent glass from breaking.

IMPORTANT: CUSTOM MEASURING SHEETS ARE REQUIRED TO PROCESS ALL CUSTOM DOOR ORDERS. Be sure to fill out completely and fax to 1-330-399-4426 attention Custom Shower Doors or email to showerdoors@mdcnw.com. Custom door orders can not be processed without receipt of the form. Custom doors are not returnable.

STERLING® Custom Pivot/Swing Shower Doors



PROLINE® FRAMED STYLE S11

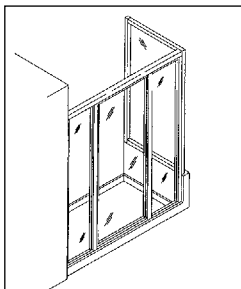

SPECIFICATIONS

PIVOT/SWING - 4800 SERIES - Style S11

Size: max. 84" total width x max. 84" height. Door: max 36" width.

Inline Panel: min. 6"/max. 24" width. Return Panel: min. 6"/max. 48" width

Features: Proline® pivot/swing framed door with two floor length inline panels and one return panel on kneewall. Includes full length handle, no towel bar.

Glass Thickness: 3/16"

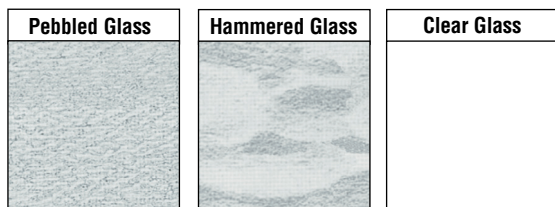
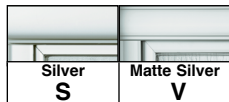

Model No.	Glass Pattern	Frame Finish			
		Silver	Matte Silver	Nickel	Deep Bronze
4800-11	Pebbled	\$1,816.50	\$1,910.90	N/A	N/A
4800-11	Hammered	\$1,816.50	\$1,910.90	N/A	N/A
4805-11	Clear	\$1,859.45	\$1,947.85	N/A	N/A

 **Custom Bath & Shower Doors.**
Allow 6 weeks for delivery. Custom doors not returnable.



PROLINE® FRAMELESS STYLE S11

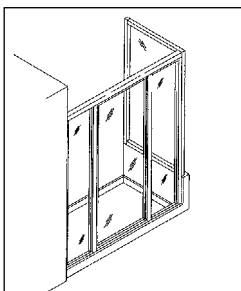

SPECIFICATIONS

PIVOT/SWING - 4900 SERIES - Style S11

Size: max. 84" total width x max. 84" height. Door: max 36" width.

Inline Panel: min. 6"/max. 24" width. Return Panel: min. 6"/max. 48" width

Features: Proline® pivot/swing frameless glass panel door with two floor length inline panels and one return panel on kneewall. Includes round single towel bar.

Glass Thickness: Frameless Doors with Clear glass are 1/4", all others 3/16"

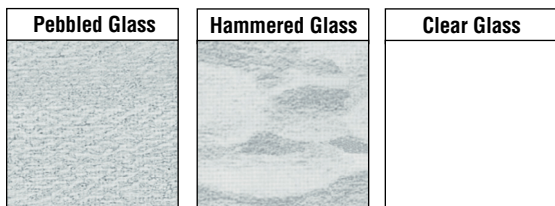

Model No.	Glass Pattern	Frame Finish			
		Silver	Matte Silver	Nickel	Deep Bronze
4900-11	Pebbled	\$1,942.65	\$2,072.55	\$2,000.65	N/A
4900-11	Hammered	\$1,942.65	\$2,072.55	\$2,000.65	N/A
4905-11	Clear	\$1,985.80	\$2,113.65	\$2,043.35	N/A

 **Custom Bath & Shower Doors.**
Allow 6 weeks for delivery. Custom doors not returnable.

NOTES:

CUSTOM MEASURING SHEETS ARE REQUIRED TO PROCESS ALL CUSTOM DOOR ORDERS. Measuring sheets must be faxed to 1-330-399-4426 Attn: Custom Shower Doors or email to: showerdoors@mdcnw.com

Custom door orders can not be processed without receipt of the form. Custom Doors are not returnable.

Notched Panels: Panels can be notched per the measuring sheet for a \$120.00 upcharge to the price.

Steam Units: Steam units are available for Framed ProLine Custom units only (4800 Series Models) at a \$75.00 upcharge to the price.

STERLING® Custom Pivot/Swing Shower Doors

CUSTOM PIVOT/SWING SHOWER DOOR MEASURING SHEET 4800 & 4900 SERIES

Sample Measuring Sheet

Style S11

Model # _____ (fill in from corresponding price page)
 ECP Price \$ _____ P.O. # _____
 Order Submitted By _____ Store # _____
 Store Location _____
 Number of Units Required _____
 Delivery Address _____
 (if different from above)
 City _____ State _____ Zip _____
 Your Customer Name _____
 Your Customer's Phone No. _____

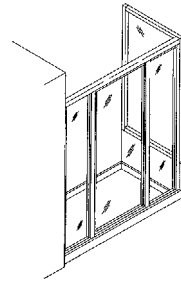

*Framed style shown.

Note: Glass panels are not the exact size of the opening. Allow for framing.

Step #1. Circle desired layout.

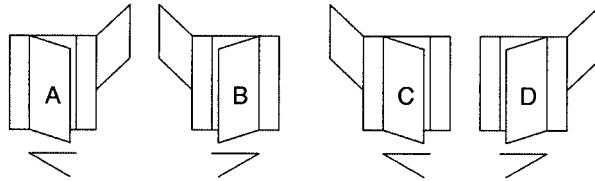

Step #2. Check door style

Framed (4800 Series) Check here if you require a steam unit. (framed models only \$75.00 upcharge.)
 Frameless (4900 Series)
**For Frameless door style, only door panel(s) is/are frameless*

Step #3. Check frame finish

Silver Nickel (Frameless only)
 Matte Silver

Step #4. Check glass type desired:
 (Please check one box only)



Pebbled

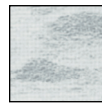

Hammered



Clear

Step #5. Measure installation area and fill in dimensions.

DIM W _____ DIM E _____
 Door Width Return Panel Width (6"min/48"max)
 DIM K _____ DIM R _____
 Inline Panel Width (6"min/24"max) Wall Height (from threshold up)
 DIM S _____ DIM H _____
 Inline Panel Width (6"min/24"max) Height (from threshold up)
 DIM L _____
 Total Width (W+K+S)

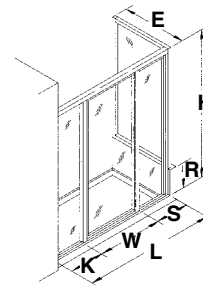

Door: max. 36" width
Inline Panel: min. 6"/max. 24" width
Return Panel: min. 6"/max. 48" width
Max. 84" total width, max. 84" height

Step #6. If required, measure panel notches and fill in dimensions.

N _____ P _____ Notched on Right
 O _____ Q _____ Notched on Left

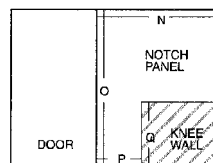

Note: Minimum notched panel dimensions = 4" x 4"
 Notched panel must be at least 7" wide (measurement P) to prevent glass from breaking.

IMPORTANT: CUSTOM MEASURING SHEETS ARE REQUIRED TO PROCESS ALL CUSTOM DOOR ORDERS. Be sure to fill out completely and fax to 1-330-399-4426 attention Custom Shower Doors or email to showerdoors@mdcnw.com. Custom door orders can not be processed without receipt of the form. Custom doors are not returnable.

STERLING® Custom Pivot/Swing Shower Doors



PROLINE® FRAMED STYLE S12

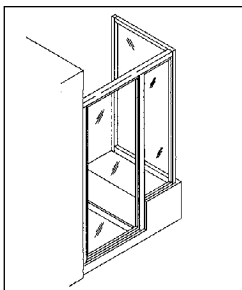

SPECIFICATIONS

PIVOT/SWING - 4800 SERIES - Style S12

Size: max. 60" total width x 84" height. Door: max 36" width.

Inline Panel: min. 6"/max. 24" width. Return Panel: min. 6"/max. 48" width

Features: Proline® pivot/swing framed door with one inline panel on kneewall and return panel on kneewall. Includes full length handle, no towel bar.

Glass Thickness: 3/16"

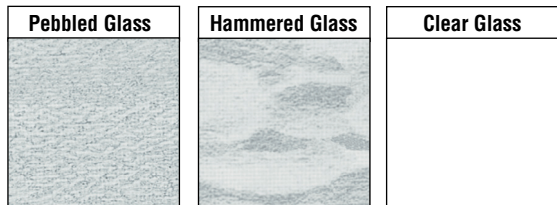
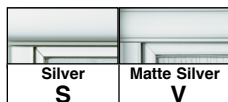

Model No.	Glass Pattern	Frame Finish			
		Silver	Matte Silver	Nickel	Deep Bronze
4800-12	Pebbled	\$1,518.90	\$1,613.75	N/A	N/A
4800-12	Hammered	\$1,518.90	\$1,613.75	N/A	N/A
4805-12	Clear	\$1,562.15	\$1,650.45	N/A	N/A

Custom Bath & Shower Doors.
Allow 6 weeks for delivery. Custom doors not returnable.



PROLINE® FRAMELESS STYLE S12

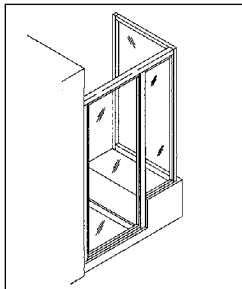

SPECIFICATIONS

PIVOT/SWING - 4900 SERIES - Style S12

Size: max. 60" total width x 84" height. Door: max 36" width.

Inline Panel: min. 6"/max. 24" width. Return Panel: min. 6"/max. 48" width

Features: Proline® pivot/swing frameless glass panel door with one inline panel on kneewall and return panel on kneewall. Includes round single towel bar.

Glass Thickness: Frameless Doors with Clear glass are 1/4", all others 3/16"

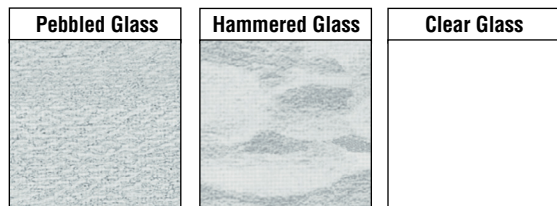

Model No.	Glass Pattern	Frame Finish			
		Silver	Matte Silver	Nickel	Deep Bronze
4900-12	Pebbled	\$1,627.45	\$1,744.10	\$1,685.20	N/A
4900-12	Hammered	\$1,627.45	\$1,744.10	\$1,685.20	N/A
4905-12	Clear	\$1,670.25	\$1,778.80	\$1,728.15	N/A

Custom Bath & Shower Doors.
Allow 6 weeks for delivery. Custom doors not returnable.

NOTES:

CUSTOM MEASURING SHEETS ARE REQUIRED TO PROCESS ALL CUSTOM DOOR ORDERS. Measuring sheets must be faxed to 1-330-399-4426 Attn: Custom Shower Doors or email to: showerdoors@mdcnw.com

Custom door orders can not be processed without receipt of the form. Custom Doors are not returnable.

Notched Panels: Panels can be notched per the measuring sheet for a \$120.00 upcharge to the price.

Steam Units: Steam units are available for Framed ProLine Custom units only (4800 Series Models) at a \$75.00 upcharge to the price.

STERLING® Custom Pivot/Swing Shower Doors

CUSTOM PIVOT/SWING SHOWER DOOR MEASURING SHEET 4800 & 4900 SERIES

Sample Measuring Sheet

Style S12

Model # _____ (fill in from corresponding price page)

ECP Price \$ _____ P.O. # _____

Order Submitted By _____ Store # _____

Store Location _____

Number of Units Required _____

Delivery Address _____

(if different from above)
City _____ State _____ Zip _____

Your Customer Name _____

Your Customer's Phone No. _____

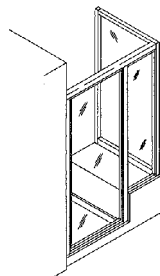

Framed* style shown.

Note: Glass panels are not the exact size of the opening. Allow for framing.

Step #1. Circle desired layout.

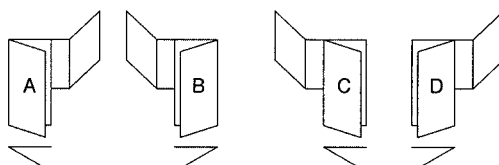

Step #2. Check door style

Framed (4800 Series) Check here if you require a steam unit. (framed models only \$75.00 upcharge.)

Frameless (4900 Series)
**For Frameless door style, only door panel(s) is/are frameless*

Step #3. Check frame finish

Silver Nickel (Frameless only)
 Matte Silver

Step #4. Check glass type desired:
(Please check one box only)



Pebbled

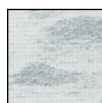

Hammered

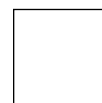

Clear

Step #5. Measure installation area and fill in dimensions.

DIM W _____
Door Width

DIM E _____
Return Panel Width (6"min/48"max)

DIM S _____
Inline Panel Width (6"min/24"max)

DIM R _____
Wall Height (from threshold up)

DIM L _____
Total Width (W+S)

DIM H _____
Height (from threshold up)

Door: max. 36" width
Inline Panel: min. 6"/max. 24" width
Return Panel: min. 6"/max. 48" width
Max. 60" total width, max. 84" height

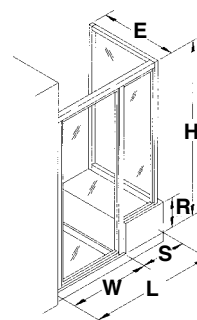

Step #6. If required, measure panel notches and fill in dimensions.

N _____ P _____ Notched on Right

O _____ Q _____ Notched on Left

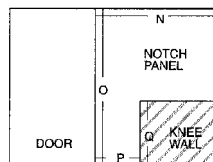

Note: Minimum notched panel dimensions = 4" x 4"
Notched panel must be at least 7" wide (measurement P) to prevent glass from breaking.

IMPORTANT: CUSTOM MEASURING SHEETS ARE REQUIRED TO PROCESS ALL CUSTOM DOOR ORDERS. Be sure to fill out completely and fax to 1-330-399-4426 attention Custom Shower Doors or email to showerdoors@mdcnw.com. Custom door orders can not be processed without receipt of the form. Custom doors are not returnable.

STERLING® Custom Pivot/Swing Shower Doors



PROLINE® FRAMED STYLE S13

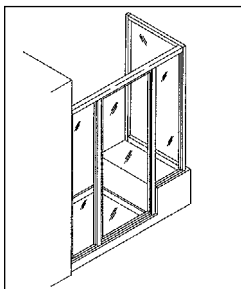

SPECIFICATIONS

PIVOT/SWING - 4800 SERIES - Style S13

Size: max. 84" total width x max. 84" height. Door: max 36" width.

Inline Panel: min. 6"/max. 24" width. Return Panel: min. 6"/max. 48" width

Features: Proline® pivot/swing framed door with one floor length inline panel, one inline panel on kneewall and one return panel on kneewall. Includes full length handle, no towel bar.

Glass Thickness: 3/16"

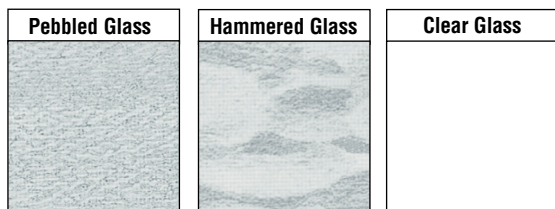
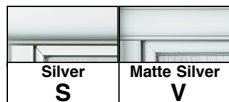

Model No.	Glass Pattern	Frame Finish			
		Silver	Matte Silver	Nickel	Deep Bronze
4800-13	Pebbled	\$1,801.40	\$1,925.25	N/A	N/A
4800-13	Hammered	\$1,801.40	\$1,925.25	N/A	N/A
4805-13	Clear	\$1,844.25	\$1,936.00	N/A	N/A

 **Custom Bath & Shower Doors.**
Allow 6 weeks for delivery. Custom doors not returnable.



PROLINE® FRAMELESS STYLE S13

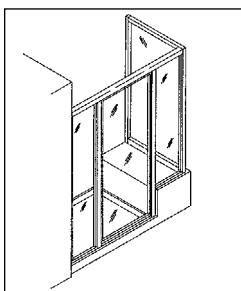

SPECIFICATIONS

PIVOT/SWING - 4900 SERIES - Style S13

Size: max. 84" total width x max. 84" height. Door: max 36" width.

Inline Panel: min. 6"/max. 24" width. Return Panel: min. 6"/max. 48" width

Features: Proline® pivot/swing frameless glass panel door with one floor length inline panel, one inline panel on kneewall and one return panel on kneewall. Includes round single towel bar.

Glass Thickness: Frameless Doors with Clear glass are 1/4", all others 3/16"

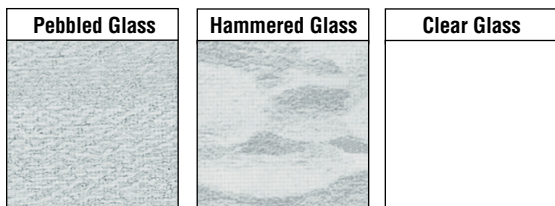

Model No.	Glass Pattern	Frame Finish			
		Silver	Matte Silver	Nickel	Deep Bronze
4900-13	Pebbled	\$1,899.55	\$2,026.75	\$1,957.65	N/A
4900-13	Hammered	\$1,899.55	\$2,026.75	\$1,957.65	N/A
4905-13	Clear	\$1,943.35	\$2,047.20	\$2,000.65	N/A

 **Custom Bath & Shower Doors.**
Allow 6 weeks for delivery. Custom doors not returnable.

NOTES:

CUSTOM MEASURING SHEETS ARE REQUIRED TO PROCESS ALL CUSTOM DOOR ORDERS. Measuring sheets must be faxed to 1-330-399-4426 Attn: Custom Shower Doors or email to: showerdoors@mdcnow.com

Custom door orders can not be processed without receipt of the form. Custom Doors are not returnable.

Notched Panels: Panels can be notched per the measuring sheet for a \$120.00 upcharge to the price.

Steam Units: Steam units are available for Framed ProLine Custom units only (4800 Series Models) at a \$75.00 upcharge to the price.

STERLING® Custom Pivot/Swing Shower Doors

CUSTOM PIVOT/SWING SHOWER DOOR MEASURING SHEET 4800 & 4900 SERIES

Sample Measuring Sheet

Style S13

Model # _____ (fill in from corresponding price page)

ECP Price \$ _____ P.O. # _____

Order Submitted By _____ Store # _____

Store Location _____

Number of Units Required _____

Delivery Address _____

(if different from above)

City _____ State _____ Zip _____

Your Customer Name _____

Your Customer's Phone No. _____

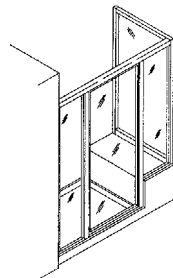

*Framed style shown.

Note: Glass panels are not the exact size of the opening. Allow for framing.

Step #1. Circle desired layout.

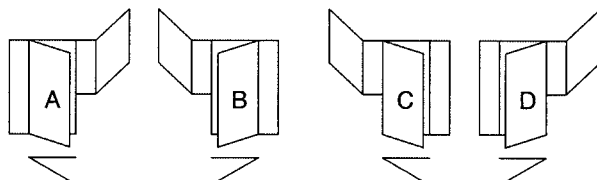

Step #2. Check door style

Framed (4800 Series) Check here if you require a steam unit. (framed models only \$75.00 upcharge.)

Frameless (4900 Series)
*For Frameless door style, only door panel(s) is/are frameless

Step #3. Check frame finish

Silver Nickel (Frameless only)
 Matte Silver

Step #4. Check glass type desired:
(Please check one box only)



Pebbled

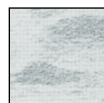

Hammered



Clear

Step #5. Measure installation area and fill in dimensions.

DIM W _____
Door Width

DIM E _____
Return Panel Width (6"min/48"max)

DIM K _____
Inline Panel Width (6"min/24"max)

DIM R _____
Wall Height (from threshold up)

DIM S _____
Inline Panel Width (6"min/24"max)

DIM H _____
Height (from threshold up)

DIM L _____
Total Width (W+K+S)

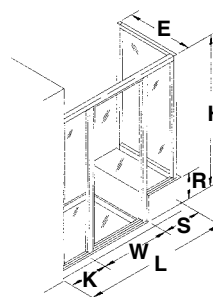

Door: max. 36" width
Inline Panel: min. 6"/max. 24" width
Return Panel: min. 6"/max. 48" width
Max. 84" total width, max. 84" height

Step #6. If required, measure panel notches and fill in dimensions.

N _____ P _____ Notched on Right

O _____ Q _____ Notched on Left

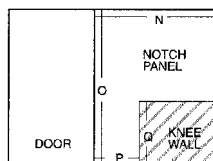

Note: Minimum notched panel dimensions = 4" x 4"
Notched panel must be at least 7" wide (measurement P) to prevent glass from breaking.

IMPORTANT: CUSTOM MEASURING SHEETS ARE REQUIRED TO PROCESS ALL CUSTOM DOOR ORDERS. Be sure to fill out completely and fax to 1-330-399-4426 attention Custom Shower Doors or email to showerdoors@mdcnw.com. Custom door orders can not be processed without receipt of the form. Custom doors are not returnable.

STERLING® Custom Pivot/Swing Shower Doors



PROLINE® FRAMED STYLE S14

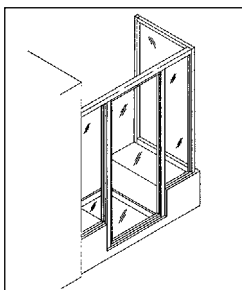

SPECIFICATIONS

PIVOT/SWING - 4800 SERIES - Style S14

Size: max. 84" total width x max. 84" height. Door: max 36" width.

Inline Panel: min. 6"/max. 24" width. Return Panel: min. 6"/max. 48" width

Features: Proline® pivot/swing framed door with two inline panels on kneewall and one return panel on kneewall. Includes full length handle, no towel bar.

Glass Thickness: 3/16"

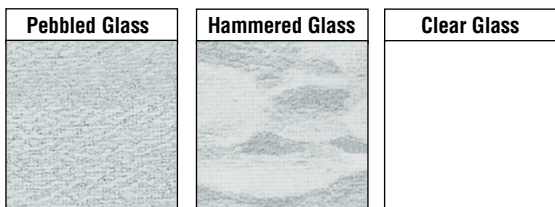
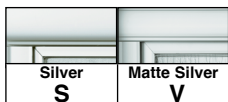

Model No.	Glass Pattern	Frame Finish			
		Silver	Matte Silver	Nickel	Deep Bronze
4800-14	Pebbled	\$1,771.35	\$1,893.55	N/A	N/A
4800-14	Hammered	\$1,771.35	\$1,893.55	N/A	N/A
4805-14	Clear	\$1,814.05	\$1,868.55	N/A	N/A

 **Custom Bath & Shower Doors.**
Allow 6 weeks for delivery. Custom doors not returnable.



PROLINE® FRAMELESS STYLE S14

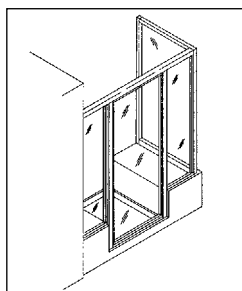

SPECIFICATIONS

PIVOT/SWING - 4900 SERIES - Style S14

Size: max. 84" total width x max. 84" height. Door: max 36" width.

Inline Panel: min. 6"/max. 24" width. Return Panel: min. 6"/max. 48" width

Features: Proline® pivot/swing frameless glass panel door with two inline panels on kneewall and one return panel on kneewall. Includes round single towel bar.

Glass Thickness: Frameless Doors with Clear glass are 1/4", all others 3/16"

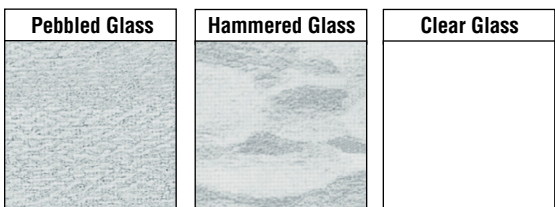
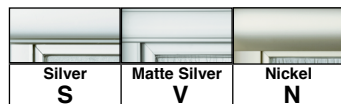

Model No.	Glass Pattern	Frame Finish			
		Silver	Matte Silver	Nickel	Deep Bronze
4900-14	Pebbled	\$2,013.40	\$2,146.45	\$2,317.90	N/A
4900-14	Hammered	\$2,013.40	\$2,146.45	\$2,317.90	N/A
4905-14	Clear	\$2,028.45	\$2,161.95	\$2,086.25	N/A

 **Custom Bath & Shower Doors.**
Allow 6 weeks for delivery. Custom doors not returnable.

NOTES:

CUSTOM MEASURING SHEETS ARE REQUIRED TO PROCESS ALL CUSTOM DOOR ORDERS. Measuring sheets must be faxed to 1-330-399-4426 Attn: Custom Shower Doors or email to: showerdoors@mdcnw.com

Custom door orders can not be processed without receipt of the form. Custom Doors are not returnable.

Notched Panels: Panels can be notched per the measuring sheet for a \$120.00 upcharge to the price.

Steam Units: Steam units are available for Framed ProLine Custom units only (4800 Series Models) at a \$75.00 upcharge to the price.

STERLING® Custom Pivot/Swing Shower Doors

CUSTOM PIVOT/SWING SHOWER DOOR MEASURING SHEET 4800 & 4900 SERIES

Sample Measuring Sheet

Style S14

Model # _____ (fill in from corresponding price page)

ECP Price \$ _____ P.O. # _____

Order Submitted By _____ Store # _____

Store Location _____

Number of Units Required _____

Delivery Address _____

(if different from above)

City _____ State _____ Zip _____

Your Customer Name _____

Your Customer's Phone No. _____

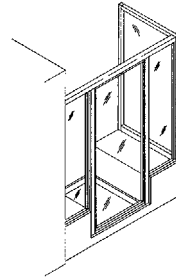

*Framed style shown.

Note: Glass panels are not the exact size of the opening. Allow for framing.

Step #1. Circle desired layout.

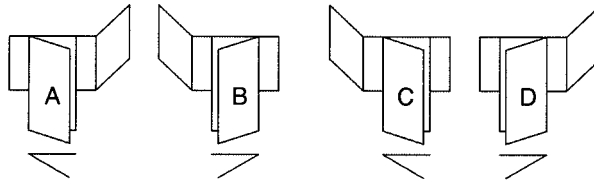

Step #2. Check door style

Framed (4800 Series) Check here if you require a steam unit. (framed models only \$75.00 upcharge.)

Frameless (4900 Series)
*For Frameless door style, only door panel(s) is/are frameless

Step #3. Check frame finish

Silver Nickel (Frameless only)

Matte Silver

Step #4. Check glass type desired:
(Please check one box only)

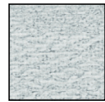

Pebbled

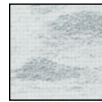

Hammered



Clear

Step #5. Measure installation area and fill in dimensions.

DIM W _____
Door Width

DIM E _____
Return Panel Width (6"min/48"max)

DIM K _____
Inline Panel Width (6"min/24"max)

DIM T _____
Wall Height (from threshold up)

DIM S _____
Inline Panel Width (6"min/24"max)

DIM R _____
Wall Height (from threshold up)

DIM L _____
Total Width (W+K+S)

DIM H _____
Height (from threshold up)

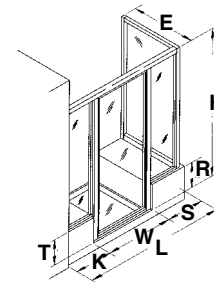

Door: max. 36" width

Inline Panel: min. 6"/max. 24" width

Return Panel: min. 6"/max. 48" width

Max. 84" total width, max. 84" height

Step #6. If required, measure panel notches and fill in dimensions.

N _____ P _____ Notched on Right

O _____ Q _____ Notched on Left

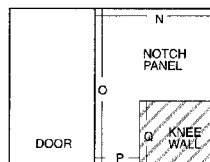

Note: Minimum notched panel dimensions = 4" x 4"
Notched panel must be at least 7" wide (measurement P) to prevent glass from breaking.

IMPORTANT: CUSTOM MEASURING SHEETS ARE REQUIRED TO PROCESS ALL CUSTOM DOOR ORDERS. Be sure to fill out completely and fax to 1-330-399-4426 attention Custom Shower Doors or email to showerdoors@mdcnw.com. Custom door orders can not be processed without receipt of the form. Custom doors are not returnable.

STERLING® Custom Sliding Bath & Shower Doors



PROLINE® FRAMED STYLE TS1

For Bath and Shower -
Bath Door shown

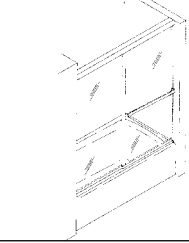

SPECIFICATIONS

SLIDING - 4600 SERIES - Style TS1

Bath Door Size: max. 72" width x max. 60" height

Shower Door Size: max. 60" width x max. 72" height

Features: Proline® sliding framed bath or shower door. Includes single towel bar.

Glass Thickness: 3/16"

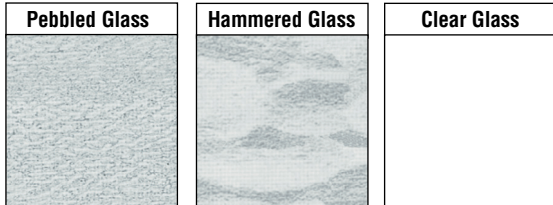

Model No.	Glass Pattern	Frame Finish			
		Silver	Matte Silver	Nickel	Deep Bronze
4600-1	Pebbled	\$936.45	\$1,023.00	N/A	N/A
4600-1	Hammered	\$936.45	\$1,023.00	N/A	N/A
4605-1	Clear	\$976.85	\$1,060.30	N/A	N/A

 **Custom Bath & Shower Doors.**
Allow 6 weeks for delivery. Custom doors not returnable.



PROLINE® FRAMELESS STYLE TS1

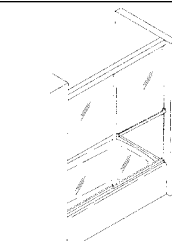

For Bath and Shower -
Bath Door shown

SPECIFICATIONS

SLIDING - 4700 SERIES - Style TS1

Bath Door Size: max. 72" width x max. 60" height

Shower Door Size: max. 60" width x max. 72" height Features: Proline® sliding bath or shower door features frameless glass panel. Includes single towel bar.

Glass Thickness: Frameless Doors with Clear glass are 1/4", all others 3/16"

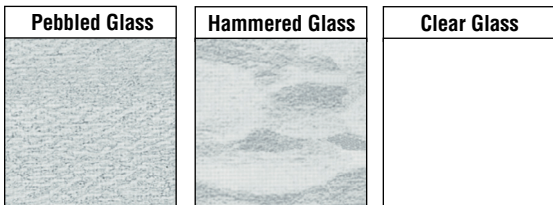

Model No.	Glass Pattern	Frame Finish			
		Silver	Matte Silver	Nickel	Deep Bronze
4700-1	Pebbled	\$1,016.80	\$1,107.80	\$1,074.60	N/A
4700-1	Hammered	\$1,016.80	\$1,107.80	\$1,074.60	N/A
4705-1	Clear	\$1,057.30	\$1,147.00	\$1,115.50	N/A

 **Custom Bath & Shower Doors.**
Allow 6 weeks for delivery. Custom doors not returnable.

NOTES:

CUSTOM MEASURING SHEETS ARE REQUIRED TO PROCESS ALL CUSTOM DOOR ORDERS. Measuring sheets must be faxed to 1-330-399-4426 Attn: Custom Shower Doors or email to: showerdoors@mdcnw.com

Custom door orders can not be processed without receipt of the form. Custom Doors are not returnable.

Notched Panels: Panels can be notched per the measuring sheet for a \$120.00 upcharge to the price.

Steam Units: Steam units are available for Framed ProLine Custom units only (4600 Series Models) at a \$150.00 upcharge to the price.

STERLING® Custom Sliding Bath & Shower Doors

CUSTOM SLIDING BATH & SHOWER DOOR MEASURING SHEET 4600 & 4700 SERIES

Sample Measuring Sheet

Style TS1

Model # _____ (fill in from corresponding price page)

ECP Price \$ _____ P.O. # _____

Order Submitted By _____ Store # _____

Store Location _____

Number of Units Required _____

Delivery Address _____

(if different from above)

City _____ State _____ Zip _____

Your Customer Name _____

Your Customer's Phone No. _____



*Framed style shown.

Note: Glass panels are not the exact size of the opening. Allow for framing.

Step #1. Check door style

Framed (4600 Series) Check here if you require a steam unit. (framed models only \$150.00 upcharge.)

Frameless (4700 Series)
*For Frameless door style, only door panel(s) is/are frameless

Step #2. Check frame finish

Silver Nickel (Frameless only)

Matte Silver

Step #3. Check glass type desired:

(Please check one box only)



Pebbled

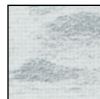

Hammered



Clear

Step #4. Measure installation area and fill in dimensions.

DIM L _____

Door Width

DIM H _____

Height (from threshold up)

Bath Door: max. 72" width, max. 60" height

Shower Door: max. 60" width, max. 72" height

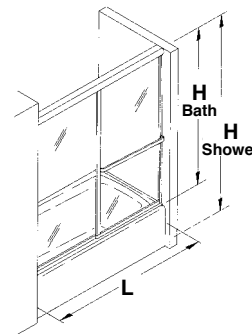

Bath Door shown.

IMPORTANT: CUSTOM MEASURING SHEETS ARE REQUIRED TO PROCESS ALL CUSTOM DOOR ORDERS. Be sure to fill out completely and fax to 1-330-399-4426 attention Custom Shower Doors or email to showerdoors@mdcnw.com. Custom door orders can not be processed without receipt of the form. Custom doors are not returnable.

STERLING® Custom Sliding Bath & Shower Doors



PROLINE® FRAMED STYLE TS2

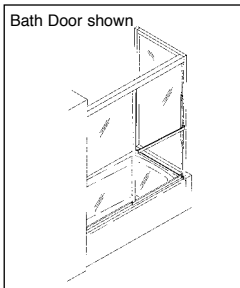

SPECIFICATIONS

SLIDING - 4600 SERIES - Style TS2
 Bath Door Size: max. 72" width x max. 60" height
 Shower Door Size: max. 60" width x max. 72" height
 Return Panel: min. 7"/max. 48" width
 Features: Proline® sliding framed bath or shower door with one return panel.
 Includes single towel bar.
 Glass Thickness: 3/16"

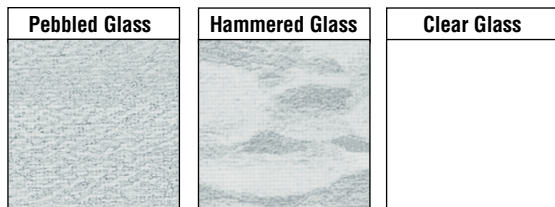
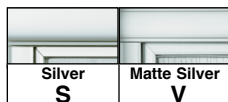

Model No.	Glass Pattern	Frame Finish			
		Silver	Matte Silver	Nickel	Deep Bronze
4600-2	Pebbled	\$1,385.30	\$1,471.10	N/A	N/A
4600-2	Hammered	\$1,385.30	\$1,471.10	N/A	N/A
4605-2	Clear	\$1,425.75	\$1,516.65	N/A	N/A

 **Custom Bath & Shower Doors.**
 Allow 6 weeks for delivery. Custom doors not returnable.



PROLINE® FRAMELESS STYLE TS2

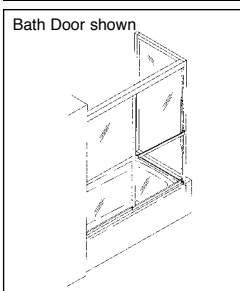

SPECIFICATIONS

SLIDING - 4700 SERIES - Style TS2
 Bath Door Size: max. 72" width x 60" height
 Shower Door Size: max. 60" width x 72" height
 Return Panel: min. 7"/max. 48" width
 Features: Proline® sliding bath or shower door with one return panel. Features frameless glass panel door. Includes single towel bar.
 Glass Thickness: Frameless Doors with Clear glass are 1/4", all others 3/16"

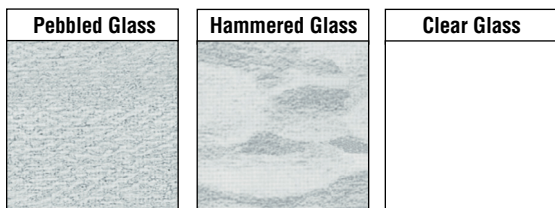

Model No.	Glass Pattern	Frame Finish			
		Silver	Matte Silver	Nickel	Deep Bronze
4700-2	Pebbled	\$1,471.10	\$1,562.15	\$1,569.25	N/A
4700-2	Hammered	\$1,471.10	\$1,562.15	\$1,569.25	N/A
4705-2	Clear	\$1,511.60	\$1,601.25	\$1,569.25	N/A

 **Custom Bath & Shower Doors.**
 Allow 6 weeks for delivery. Custom doors not returnable.

NOTES:

CUSTOM MEASURING SHEETS ARE REQUIRED TO PROCESS ALL CUSTOM DOOR ORDERS. Measuring sheets must be faxed to 1-330-399-4426 Attn: Custom Shower Doors or email to: showerdoors@mdcnw.com

Custom door orders can not be processed without receipt of the form. Custom Doors are not returnable.

Notched Panels: Panels can be notched per the measuring sheet for a \$120.00 upcharge to the price.

Steam Units: Steam units are available for Framed ProLine Custom units only (4600 Series Models) at a \$150.00 upcharge to the price.

STERLING® Custom Sliding Bath & Shower Doors

CUSTOM SLIDING BATH & SHOWER DOOR MEASURING SHEET 4600 & 4700 SERIES

Sample Measuring Sheet

Style TS2

Model # _____ (fill in from corresponding price page)

ECP Price \$ _____ P.O. # _____

Order Submitted By _____ Store # _____

Store Location _____

Number of Units Required _____

Delivery Address _____

(if different from above)

City _____ State _____ Zip _____

Your Customer Name _____

Your Customer's Phone No. _____

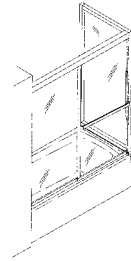

*Framed style shown.

Note: Glass panels are not the exact size of the opening. Allow for framing.

Step #1. Check door style

Framed (4600 Series) Check here if you require a steam unit. (framed models only \$150.00 upcharge.)

Frameless (4700 Series)
*For Frameless door style, only door panel(s) is/are frameless

Step #2. Designate return panel.

Right

Left

Step #3. Check frame finish

Silver Nickel (Frameless only)

Matte Silver

Step #4. Check glass type desired: (Please check one box only)



Pebbled

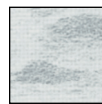

Hammered



Clear

Step #5. Measure installation area and fill in dimensions.

DIM L _____
Door Width

DIM E _____
Return Panel Width (7"min/48"max)

DIM H _____
Height (from top of bath or threshold up)

Bath Door: max. 72" width, max. 60" height
Shower Door: max. 60" width, max. 72" height
Return Panel: min. 7"/max. 48" width

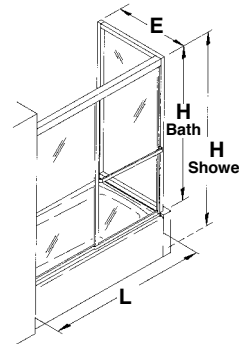

IMPORTANT: CUSTOM MEASURING SHEETS ARE REQUIRED TO PROCESS ALL CUSTOM DOOR ORDERS. Be sure to fill out completely and fax to 1-330-399-4426 attention Custom Shower Doors or email to showerdoors@mdcnw.com. Custom door orders can not be processed without receipt of the form. Custom doors are not returnable.

STERLING® Custom Sliding Bath & Shower Doors

STERLING PROLINE® FRAMED STYLE TS3

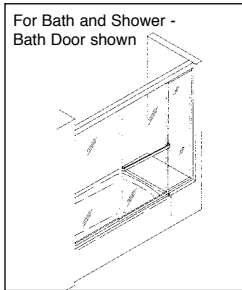

SPECIFICATIONS

SLIDING - 4600 SERIES - Style TS3

Bath Door Size: max. 72" width x max. 60" height Bath Door & Inline: max. 96" width

Shower Door Size: max. 60" width x max. 72" height. Shwr Dr & Inline: max. 84" w

Inline Panel: min. 7"/max. 24" width

Features: Proline® sliding framed bath or shower door with one inline panel.

Includes single towel bar.

Glass Thickness: 3/16"

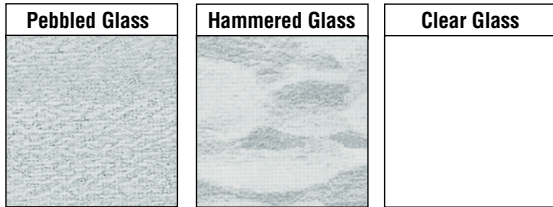

Model No.	Glass Pattern	Frame Finish			
		Silver	Matte Silver	Nickel	Deep Bronze
4600-3	Pebbled	\$1,299.90	\$1,386.10	N/A	N/A
4600-3	Hammered	\$1,299.90	\$1,386.10	N/A	N/A
4605-3	Clear	\$1,340.05	\$1,427.65	N/A	N/A

 **Custom Bath & Shower Doors.**
Allow 6 weeks for delivery. Custom doors not returnable.

STERLING PROLINE® FRAMELESS STYLE TS3

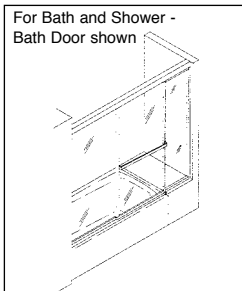

SPECIFICATIONS

SLIDING - 4700 SERIES - Style TS3

Bath Door Size: max. 72" width x 60" height Bath Door & Inline: max. 96" width

Shower Door Size: max. 60" width x 72" height. Shwr Dr & Inline: max. 84" w

Inline Panel: min. 7"/max. 24" width

Features: Proline® sliding Bath or Shower Door with one inline panel.

Features frameless glass panel door. Includes single towel bar.

Glass Thickness: Frameless Doors with Clear glass are 1/4", all others 3/16"

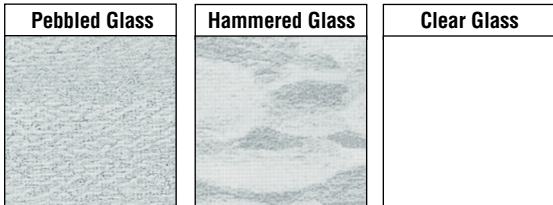

Model No.	Glass Pattern	Frame Finish			
		Silver	Matte Silver	Nickel	Deep Bronze
4700-3	Pebbled	\$1,387.80	\$1,477.35	\$1,445.65	N/A
4700-3	Hammered	\$1,387.80	\$1,477.35	\$1,445.65	N/A
4705-3	Clear	\$1,427.65	\$1,518.75	\$1,485.75	N/A

 **Custom Bath & Shower Doors.**
Allow 6 weeks for delivery. Custom doors not returnable.

NOTES:

CUSTOM MEASURING SHEETS ARE REQUIRED TO PROCESS ALL CUSTOM DOOR ORDERS. Measuring sheets must be faxed to 1-330-399-4426 Attn: Custom Shower Doors or email to: showerdoors@mdcnw.com

Custom door orders can not be processed without receipt of the form. Custom Doors are not returnable.

Notched Panels: Panels can be notched per the measuring sheet for a \$120.00 upcharge to the price.

Steam Units: Steam units are available for Framed ProLine Custom units only (4600 Series Models) at a \$150.00 upcharge to the price.

STERLING® Custom Sliding Bath & Shower Doors

CUSTOM SLIDING BATH & SHOWER DOOR MEASURING SHEET 4600 & 4700 SERIES

Sample Measuring Sheet

Style TS3

Model # _____ (fill in from corresponding price page)
 ECP Price \$ _____ P.O. # _____
 Order Submitted By _____ Store # _____
 Store Location _____
 Number of Units Required _____
 Delivery Address _____
 (if different from above)
 City _____ State _____ Zip _____
 Your Customer Name _____
 Your Customer's Phone No. _____

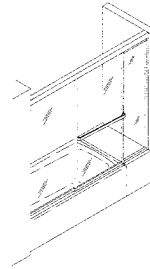

*Framed style shown.

Note: Glass panels are not the exact size of the opening. Allow for framing.

Step #1. Check door style

- Framed (4600 Series) Check here if you require a steam unit. (framed models only \$150.00 upcharge.)
- Frameless (4700 Series)
**For Frameless door style, only door panel(s) is/are frameless*

Step #2. Check frame finish

- Silver Nickel (Frameless only)
- Matte Silver

Step #3. Check glass type desired:

(Please check one box only)



Pebbled

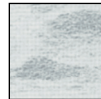

Hammered



Clear

Step #4. Measure installation area and fill in dimensions.

DIM W _____ DIM H _____
 Door Width Height (from top of bath or threshold up)

DIM S _____
 Inline Panel Width (7"min/24"max)

DIM L _____
 Total Width (W+S)

Bath Door: max. 72" width, max. 60" height
Shower Door: max. 60" width, max. 72" height
Inline Panel: min. 7"/max. 24" width
Bath Door and Inline: max 96" width
Shower Door and Inline: max. 84" width

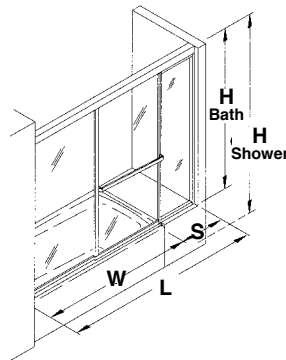

IMPORTANT: CUSTOM MEASURING SHEETS ARE REQUIRED TO PROCESS ALL CUSTOM DOOR ORDERS. Be sure to fill out completely and fax to 1-330-399-4426 attention Custom Shower Doors or email to showerdoors@mdcnw.com. Custom door orders can not be processed without receipt of the form. Custom doors are not returnable.

STERLING® Custom Sliding Bath & Shower Doors

STERLING® PROLINE® FRAMED STYLE TS4

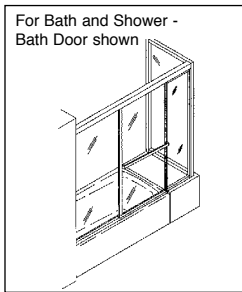

SPECIFICATIONS

SLIDING - 4600 SERIES - Style TS4

Bath Door Size: max. 72" width x max. 60" height Bath Door & Inline: max. 96" width
 Shower Door Size: max. 60" width x max. 72" height. Shower Door & Inline: max. 84" w
 Inline Panel: min. 7"/max. 24" width. Return Panel: min. 7"/max. 48" width.
 Features: Proline® sliding framed bath or shower door with one inline panel and one return panel. Includes single towel bar.
 Glass Thickness: 3/16"

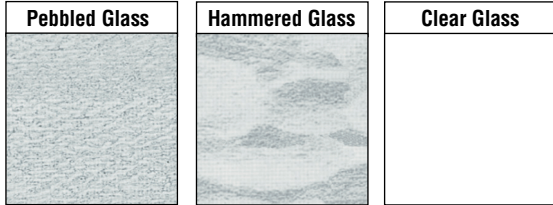

Model No.	Glass Pattern	Frame Finish			
		Silver	Matte Silver	Nickel	Deep Bronze
4600-4	Pebbled	\$1,728.30	\$1,849.30	N/A	N/A
4600-4	Hammered	\$1,728.30	\$1,849.30	N/A	N/A
4605-4	Clear	\$1,768.65	\$1,891.00	N/A	N/A

 **Custom Bath & Shower Doors.**
 Allow 6 weeks for delivery. Custom doors not returnable.

STERLING® PROLINE® FRAMELESS STYLE TS4

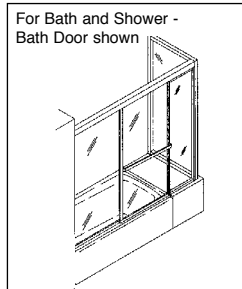

SPECIFICATIONS

SLIDING - 4700 SERIES - Style TS4

Bath Door Size: max. 72" width x max. 60" height Bath Door & Inline: max. 96" width
 Shower Door Size: max. 60" width x max. 72" height. Shower Door & Inline: max. 84" w
 Inline Panel: min. 7"/max. 24" width. Return Panel: min. 7"/max. 48" width.
 Features: Proline® sliding bath or shower door with one inline panel and one return panel.
 Features frameless glass panel door. Includes single towel bar.
 Glass Thickness: Frameless Doors with Clear glass are 1/4", all others 3/16"

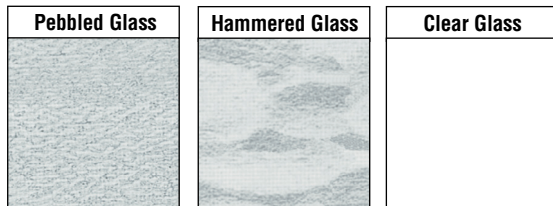

Model No.	Glass Pattern	Frame Finish			
		Silver	Matte Silver	Nickel	Deep Bronze
4700-4	Pebbled	\$1,818.90	\$1,943.90	\$1,876.90	N/A
4700-4	Hammered	\$1,818.90	\$1,943.90	\$1,876.90	N/A
4705-4	Clear	\$1,859.45	\$1,988.15	\$1,920.25	N/A

 **Custom Bath & Shower Doors.**
 Allow 6 weeks for delivery. Custom doors not returnable.

NOTES:

CUSTOM MEASURING SHEETS ARE REQUIRED TO PROCESS ALL CUSTOM DOOR ORDERS. Measuring sheets must be faxed to 1-330-399-4426 Attn: Custom Shower Doors or email to: showerdoors@mdcnw.com

Custom door orders can not be processed without receipt of the form. Custom Doors are not returnable.

Notched Panels: Panels can be notched per the measuring sheet for a \$120.00 upcharge to the price.

Steam Units: Steam units are available for Framed ProLine Custom units only (4600 Series Models) at a \$150.00 upcharge to the price.

STERLING® Custom Sliding Bath & Shower Doors

CUSTOM SLIDING BATH & SHOWER DOOR MEASURING SHEET 4600 & 4700 SERIES

Sample Measuring Sheet

Style TS4

Model # _____ (fill in from corresponding price page)

ECP Price \$ _____ P.O. # _____

Order Submitted By _____ Store # _____

Store Location _____

Number of Units Required _____

Delivery Address _____

(if different from above)

City _____ State _____ Zip _____

Your Customer Name _____

Your Customer's Phone No. _____

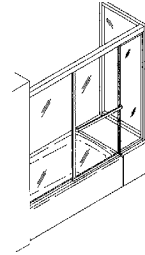

*Framed style shown.

Note: Glass panels are not the exact size of the opening. Allow for framing.

Step #1. Check door style

Framed (4600 Series) Check here if you require a steam unit. (framed models only \$150.00 upcharge.)

Frameless (4700 Series)
*For Frameless door style, only door panel(s) is/are frameless

Step #2. Designate return panel.

Right

Left

Step #3. Check frame finish

Silver Nickel (Frameless only)

Matte Silver

Step #4. Check glass type desired: (Please check one box only)



Pebbled

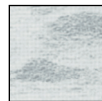

Hammered



Clear

Step #5. Measure installation area and fill in dimensions.

DIM W _____ DIM H _____
Door Width Height (from top of bath or threshold up)

DIM S _____ DIM E _____
Inline Panel Width (7"min/24"max) Return Panel Width (7"min/48"max)

DIM L _____
Total Width (W+S)

Bath Door: max. 72" width, max. 60" height
Shower Door: max. 60" width, max. 72" height
Inline Panel: min. 7"/max. 24" width
Return Panel: min. 7"/max. 48" width
Bath Door and Inline: max 96" width
Shower Door and Inline: max. 84" width

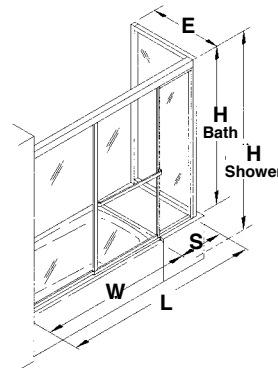

IMPORTANT: CUSTOM MEASURING SHEETS ARE REQUIRED TO PROCESS ALL CUSTOM DOOR ORDERS. Be sure to fill out completely and fax to 1-330-399-4426 attention Custom Shower Doors or email to showerdoors@mdcnw.com. Custom door orders can not be processed without receipt of the form. Custom doors are not returnable.

STERLING® Custom Sliding Bath & Shower Doors

STERLING® PROLINE® FRAMED STYLE TS5

For Bath and Shower -
Bath Door shown

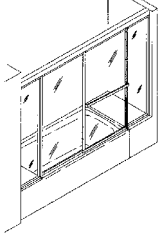

SPECIFICATIONS

SLIDING - 4600 SERIES - Style TS5

Bath Door Size: max. 72" width x max. 60" height Bath Door & Inline: max. 96" width

Shower Door Size: max. 60" width x max. 72" height. Shower Door & Inline: max. 84" w.

Inline Panel: min. 7"/max. 24" width. **Note: Not to exceed total width: Bath 96", Shower 96"**

Features: Proline® sliding framed bath or shower door with two inline panels. Includes single towel bar

Glass Thickness: 3/16"

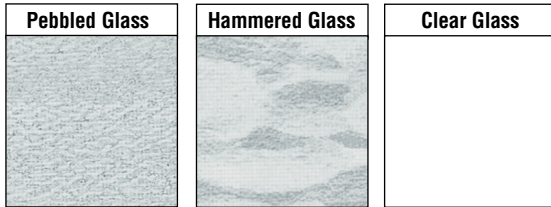

Model No.	Glass Pattern	Frame Finish			
		Silver	Matte Silver	Nickel	Deep Bronze
4600-5	Pebbled	\$1,632.45	\$1,718.00	N/A	N/A
4600-5	Hammered	\$1,632.45	\$1,718.00	N/A	N/A
4605-5	Clear	\$1,673.00	\$1,760.35	N/A	N/A

 **Custom Bath & Shower Doors.**
Allow 6 weeks
for delivery. Custom
doors not returnable.

STERLING® PROLINE® FRAMELESS STYLE TS5

For Bath and Shower -
Bath Door shown

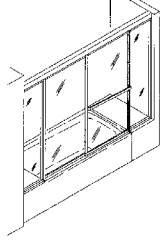

SPECIFICATIONS

SLIDING - 4700 SERIES - Style TS5

Bath Door Size: max. 72" width x max. 60" height Bath Door & Inline: max. 96" width

Shower Door Size: max. 60" width x max. 72" height. Shower Door & Inline: max. 84" w.

Inline Panel: min. 7"/max. 24" width. **Note: Not to exceed total width: Bath 96", Shower 96"**

Features: Proline® sliding bath or shower door with two inline panels. Features frameless glass panel door.

Includes single towel bar. Glass Thickness: Frameless Doors with Clear glass are 1/4", all others 3/16"

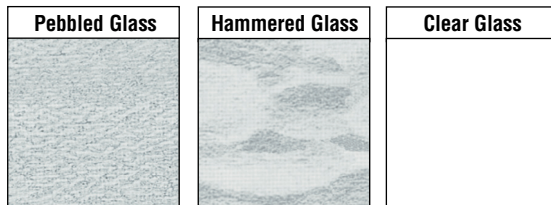
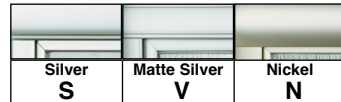

Model No.	Glass Pattern	Frame Finish			
		Silver	Matte Silver	Nickel	Deep Bronze
4700-5	Pebbled	\$1,723.30	\$1,843.50	\$1,781.15	N/A
4700-5	Hammered	\$1,723.30	\$1,843.50	\$1,781.15	N/A
4705-5	Clear	\$1,859.45	\$1,885.95	\$1,821.50	N/A

 **Custom Bath & Shower Doors.**
Allow 6 weeks
for delivery. Custom
doors not returnable.

NOTES:

CUSTOM MEASURING SHEETS ARE REQUIRED TO PROCESS ALL CUSTOM DOOR ORDERS. Measuring sheets must be faxed to 1-330-399-4426 Attn: Custom Shower Doors or email to: showerdoors@mdcnw.com

Custom door orders can not be processed without receipt of the form. Custom Doors are not returnable.

Notched Panels: Panels can be notched per the measuring sheet for a \$120.00 upcharge to the price.

Steam Units: Steam units are available for Framed ProLine Custom units only (4600 Series Models) at a \$150.00 upcharge to the price.

STERLING® Custom Sliding Bath & Shower Doors

CUSTOM SLIDING BATH & SHOWER DOOR MEASURING SHEET 4600 & 4700 SERIES

Sample Measuring Sheet

Style TS5

Model # _____ (fill in from corresponding price page)

ECP Price \$ _____ P.O. # _____

Order Submitted By _____ Store # _____

Store Location _____

Number of Units Required _____

Delivery Address _____

(if different from above)

City _____ State _____ Zip _____

Your Customer Name _____

Your Customer's Phone No. _____

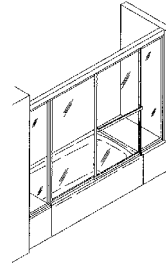

*Framed style shown.

Note: Glass panels are not the exact size of the opening. Allow for framing.

Step #1. Check door style

Framed (4600 Series) Check here if you require a steam unit. (framed models only \$150.00 upcharge.)

Frameless (4700 Series)
*For Frameless door style, only door panel(s) is/are frameless

Step #2. Check frame finish

Silver Nickel (Frameless only)

Matte Silver

Step #3. Check glass type desired: (Please check one box only)



Pebbled

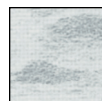

Hammered



Clear

Step #4. Measure installation area and fill in dimensions.

DIM W _____
Door Width

DIM H _____
Height (from top of bath or threshold up)

DIM K _____
Inline Panel Width (7"min/24"max)

DIM S _____
Inline Panel Width (7"min/24"max)

DIM L _____
Total Width (W+K+S)

Bath Door: max. 72" width, max. 60" height
Shower Door: max. 60" width, max. 72" height
Inline Panel: min. 7"/max. 24" width

Not to exceed total width: Bath 96", Shower 96"

Bath Door shown

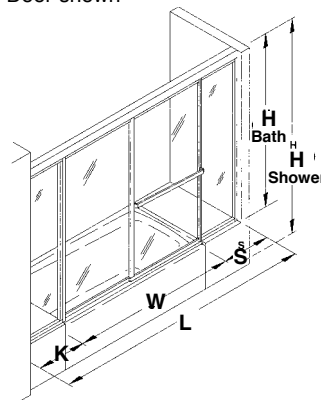

IMPORTANT: CUSTOM MEASURING SHEETS ARE REQUIRED TO PROCESS ALL CUSTOM DOOR ORDERS. Be sure to fill out completely and fax to 1-330-399-4426 attention Custom Shower Doors or email to showerdoors@mdcnw.com. Custom door orders can not be processed without receipt of the form. Custom doors are not returnable.

STERLING® Custom Sliding Bath & Shower Doors



PROLINE® FRAMED STYLE TS6

For Bath and Shower -
Bath Door shown

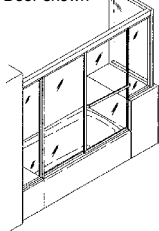

SPECIFICATIONS

SLIDING - 4600 SERIES - Style TS6

Bath Door Size: max. 72" width x max. 60" height

Shower Door Size: max. 60" width x max. 72" height. Inline Panel: min. 7"/max. 24" width.

Return Panel: min. 7"/max 48" width. **Note: Not to exceed total width: Bath 96", Shower 96"**

Features: Proline® sliding framed bath or shower door with one full length inline panel, one inline panel and one return panel on kneewall. Includes single towel bar.

Glass Thickness: 3/16"

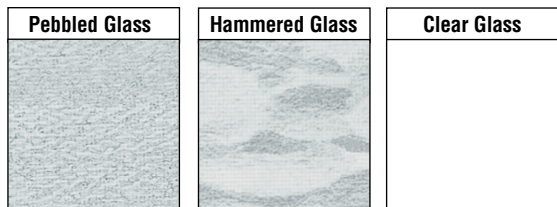
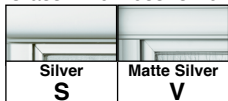

Model No.	Glass Pattern	Frame Finish			
		Silver	Matte Silver	Nickel	Deep Bronze
4600-6	Pebbled	\$1,783.90	\$1,860.80	N/A	N/A
4600-6	Hammered	\$1,783.90	\$1,860.80	N/A	N/A
4605-6	Clear	\$1,824.05	\$1,949.05	N/A	N/A

 **Custom Bath & Shower Doors.**
Allow 6 weeks for delivery. Custom doors not returnable.



PROLINE® FRAMELESS STYLE TS6

For Bath and Shower -
Bath Door shown

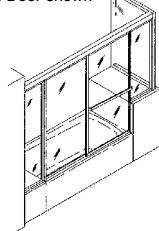

SPECIFICATIONS

SLIDING - 4700 SERIES - Style TS6

Bath Door Size: max. 72" width x max. 60" height

Shower Door Size: max. 60" width x max. 72" height. Inline Panel: min. 7"/max. 24" width.

Return Panel: min. 7"/max. 48" width. **Note: Not to exceed total width: Bath 96", Shower 96"**

Features: Proline® sliding bath or shower door with with one full length inline panel, one inline panel and one return panel on kneewall. Features frameless glass panel door. Includes single towel bar.

Glass Thickness: Frameless Doors with Clear glass are 1/4", all others 3/16"

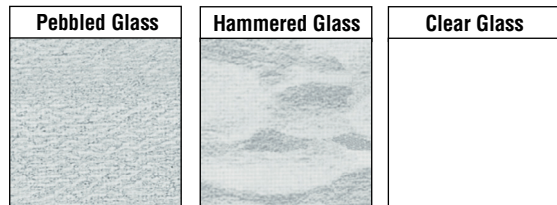
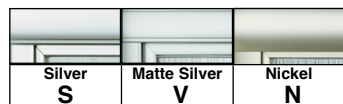

Model No.	Glass Pattern	Frame Finish			
		Silver	Matte Silver	Nickel	Deep Bronze
4700-6	Pebbled	\$1,869.60	\$1,995.95	\$1,926.50	N/A
4700-6	Hammered	\$1,869.60	\$1,995.95	\$1,926.50	N/A
4705-6	Clear	\$1,592.80	\$2,038.45	\$1,968.55	N/A

 **Custom Bath & Shower Doors.**
Allow 6 weeks for delivery. Custom doors not returnable.

NOTES:

CUSTOM MEASURING SHEETS ARE REQUIRED TO PROCESS ALL CUSTOM DOOR ORDERS. Measuring sheets must be faxed to 1-330-399-4426 Attn: Custom Shower Doors or email to: showerdoors@mdcnw.com

Custom door orders can not be processed without receipt of the form. Custom Doors are not returnable.

Notched Panels: Panels can be notched per the measuring sheet for a \$120.00 upcharge to the price.

Steam Units: Steam units are available for Framed ProLine Custom units only (4600 Series Models) at a \$150.00 upcharge to the price.

STERLING® Custom Sliding Bath & Shower Doors

CUSTOM SLIDING BATH & SHOWER DOOR MEASURING SHEET 4600 & 4700 SERIES

Sample Measuring Sheet

Style TS6

Model # _____ (fill in from corresponding price page)

ECP Price \$ _____ P.O. # _____

Order Submitted By _____ Store # _____

Store Location _____

Number of Units Required _____

Delivery Address _____

(if different from above)

City _____ State _____ Zip _____

Your Customer Name _____

Your Customer's Phone No. _____

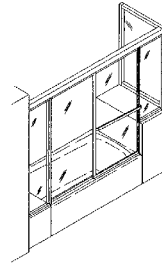

*Framed style shown.

Note: Glass panels are not the exact size of the opening. Allow for framing.

Step #1. Check door style

- Framed (4600 Series) Check here if you require a steam unit. (framed models only \$150.00 upcharge.)
- Frameless (4700 Series)
*For Frameless door style, only door panel(s) is/are frameless

Step #2. Designate return panel.

- Right
- Left

Step #3. Check frame finish

- Silver Nickel (Frameless only)
- Matte Silver

Step #4. Check glass type desired: (Please check one box only)



Pebbled

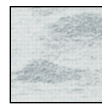

Hammered



Clear

Step #5. Measure installation area and fill in dimensions.

- DIM W _____ DIM H _____
Door Width Height (from top of bath or threshold up)
- DIM K _____ DIM E _____
Inline Panel Width (7"min/24"max) Return Panel Width (7"min/48"max)
- DIM S _____ DIM R _____
Inline Panel Width (7"min/24"max) Wall Height (from top of bath or threshold up)
- DIM L _____
Total Width (W+K+S)

Bath Door shown

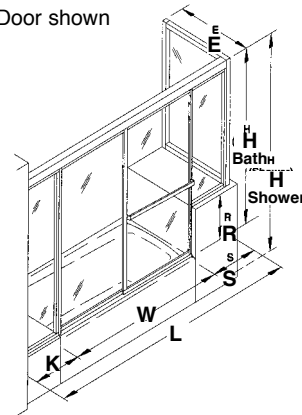

Bath Door: max. 72" width, max. 60" height
Shower Door: max. 60" width, max. 72" height
Inline Panel: min. 7"/max. 24" width
Return Panel: min. 7"/max. 48" width

Not to exceed total width: Bath 96", Shower 96"

Step #6. If required, measure panel notches and fill in dimensions.

- N _____ P _____ Notched on Right
- O _____ Q _____ Notched on Left

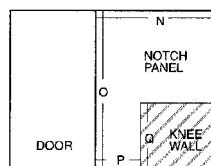

Note: Minimum notched panel dimensions = 4" x 4"
 Notched panel must be at least 7" wide (measurement P) to prevent glass from breaking.

IMPORTANT: CUSTOM MEASURING SHEETS ARE REQUIRED TO PROCESS ALL CUSTOM DOOR ORDERS. Be sure to fill out completely and fax to 1-330-399-4426 attention Custom Shower Doors or email to showerdoors@mdcnw.com. Custom door orders can not be processed without receipt of the form. Custom doors are not returnable.

STERLING® Custom Sliding Bath & Shower Doors

STERLING® PROLINE® FRAMED STYLE TS7

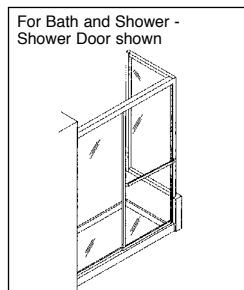

SPECIFICATIONS

SLIDING - 4600 SERIES - Style TS7
 Bath Door Size: max. 72" width x max. 60" height
 Shower Door Size: max. 60" width x max. 72" height. Return Panel: min. 7"/max. 48" width
 Features: Proline® sliding framed bath or shower door with one return panel on kneewall. Includes single towel bar.
 Glass Thickness: 3/16"

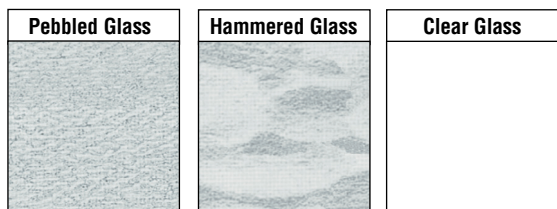
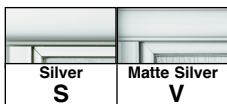

Model No.	Glass Pattern	Frame Finish			
		Silver	Matte Silver	Nickel	Deep Bronze
4600-7	Pebbled	\$1,367.90	\$1,456.75	N/A	N/A
4600-7	Hammered	\$1,367.90	\$1,456.75	N/A	N/A
4605-7	Clear	\$1,408.35	\$1,492.25	N/A	N/A

 **Custom Bath & Shower Doors.**
 Allow 6 weeks for delivery. Custom doors not returnable.

STERLING® PROLINE® FRAMELESS STYLE TS7

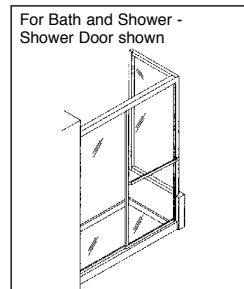

SPECIFICATIONS

SLIDING - 4700 SERIES - Style TS7
 Bath Door Size: max. 72" width x 60" height
 Shower Door Size: max. 60" width x 72" height. Return Panel: min. 7"/max. 48" width
 Features: Proline® sliding bath or shower door with one return panel on kneewall.
 Features frameless glass panel door. Includes single towel bar.
 Glass Thickness: Frameless Doors with Clear glass are 1/4", all others 3/16"

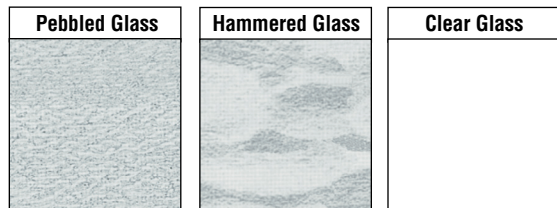
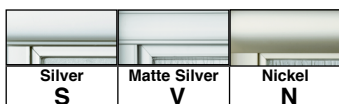

Model No.	Glass Pattern	Frame Finish			
		Silver	Matte Silver	Nickel	Deep Bronze
4700-7	Pebbled	\$1,443.35	\$1,535.20	\$1,501.00	N/A
4700-7	Hammered	\$1,443.35	\$1,535.20	\$1,501.00	N/A
4705-7	Clear	\$1,483.60	\$1,575.30	\$1,541.35	N/A

 **Custom Bath & Shower Doors.**
 Allow 6 weeks for delivery. Custom doors not returnable.

NOTES:

CUSTOM MEASURING SHEETS ARE REQUIRED TO PROCESS ALL CUSTOM DOOR ORDERS. Measuring sheets must be faxed to 1-330-399-4426 Attn: Custom Shower Doors or email to: showerdoors@mdcnw.com

Custom door orders can not be processed without receipt of the form. Custom Doors are not returnable.

Notched Panels: Panels can be notched per the measuring sheet for a \$120.00 upcharge to the price.

Steam Units: Steam units are available for Framed ProLine Custom units only (4600 Series Models) at a \$150.00 upcharge to the price.

STERLING® Custom Sliding Bath & Shower Doors

CUSTOM SLIDING BATH & SHOWER DOOR MEASURING SHEET 4600 & 4700 SERIES

Sample Measuring Sheet

Style TS7

Model # _____ (fill in from corresponding price page)

ECP Price \$ _____ P.O. # _____

Order Submitted By _____ Store # _____

Store Location _____

Number of Units Required _____

Delivery Address _____

(if different from above)

City _____ State _____ Zip _____

Your Customer Name _____

Your Customer's Phone No. _____

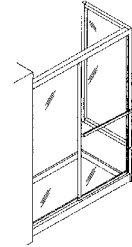

*Framed style shown.

Note: Glass panels are not the exact size of the opening. Allow for framing.

Step #1. Check door style

Framed (4600 Series) Check here if you require a steam unit. (framed models only \$150.00 upcharge.)

Frameless (4700 Series)
*For Frameless door style, only door panel(s) is/are frameless

Step #2. Designate return panel.

Right

Left

Step #3. Check frame finish

Silver Nickel (Frameless only)

Matte Silver

Step #4. Check glass type desired:

(Please check one box only)



Pebbled

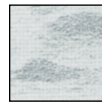

Hammered



Clear

Step #5. Measure installation area and fill in dimensions.

DIM L _____
Door Width

DIM E _____
Return Panel Width (7"min/48"max)

DIM H _____
Height
(from top of bath or threshold up)

DIM R _____
Wall Height
(from top of bath or threshold up)

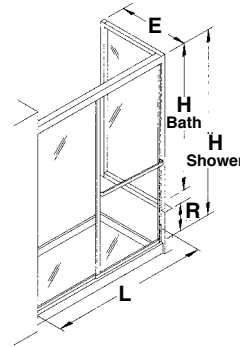

Bath Door: max. 72" width, max. 60" height

Shower Door: max. 60" width, max. 72" height

Return Panel: min. 7"/max. 48" width

Step #6. If required, measure panel notches and fill in dimensions.

N _____ P _____ Notched on Right

O _____ Q _____ Notched on Left

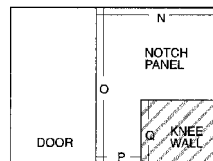

Note: Minimum notched panel dimensions = 4" x 4"
Notched panel must be at least 7" wide (measurement P) to prevent glass from breaking.

IMPORTANT: CUSTOM MEASURING SHEETS ARE REQUIRED TO PROCESS ALL CUSTOM DOOR ORDERS. Be sure to fill out completely and fax to 1-330-399-4426 attention Custom Shower Doors or email to showerdoors@mdcnw.com. Custom door orders can not be processed without receipt of the form. Custom doors are not returnable.

STERLING® Custom Sliding Bath & Shower Doors



PROLINE® FRAMED STYLE TS8

For Bath and Shower - Shower Door shown

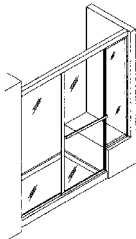

SPECIFICATIONS

SLIDING - 4600 SERIES - Style TS8

Bath Door Size: max. 72" width x max. 60" height Bath Door & Inline: max. 96" width

Shower Door Size: max. 60" width x max. 72" height. Shwr Dr & Inline: max. 84" w

Inline Panel: min. 7"/max. 24" width. **Note: Not to exceed total width: Bath 96", Shower 96"**

Features: Proline® sliding framed bath or shower door with one inline panel on kneewall.

Includes single towel bar.

Glass Thickness: 3/16"

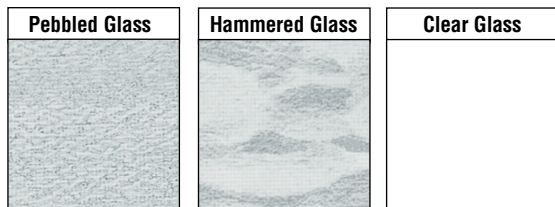
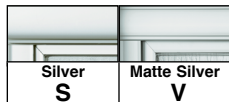

Model No.	Glass Pattern	Frame Finish			
		Silver	Matte Silver	Nickel	Deep Bronze
4600-8	Pebbled	\$1,287.40	\$1,374.45	N/A	N/A
4600-8	Hammered	\$1,287.40	\$1,374.45	N/A	N/A
4605-8	Clear	\$1,326.70	\$1,415.45	N/A	N/A

 **Custom Bath & Shower Doors.**
Allow 6 weeks for delivery. Custom doors not returnable.



PROLINE® FRAMELESS STYLE TS8

For Bath and Shower - Shower Door shown

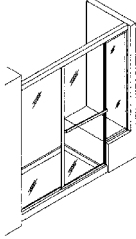

SPECIFICATIONS

SLIDING - 4700 SERIES - Style TS8

Bath Door Size: max. 72" width x 60" height Bath Door & Inline: max. 96" width

Shower Door Size: max. 60" width x 72" height. Shwr Dr & Inline: max. 84" w

Inline Panel: min. 7"/max. 24" width. **Note: Not to exceed total width: Bath 96", Shower 96"**

Features: Proline® sliding Bath or Shower Door with one inline panel on kneewall.

Features frameless glass panel door. Includes single towel bar.

Glass Thickness: Frameless Doors with Clear glass are 1/4", all others 3/16"

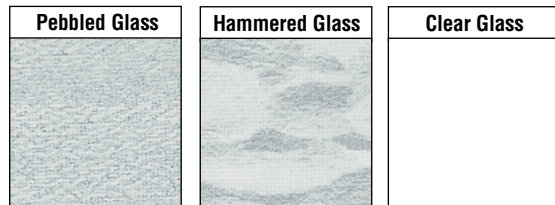

Model No.	Glass Pattern	Frame Finish			
		Silver	Matte Silver	Nickel	Deep Bronze
4700-8	Pebbled	\$1,367.90	\$1,473.00	\$1,425.60	N/A
4700-8	Hammered	\$1,367.90	\$1,473.00	\$1,425.60	N/A
4705-8	Clear	\$1,408.35	\$1,498.20	\$1,465.90	N/A

 **Custom Bath & Shower Doors.**
Allow 6 weeks for delivery. Custom doors not returnable.

NOTES:

CUSTOM MEASURING SHEETS ARE REQUIRED TO PROCESS ALL CUSTOM DOOR ORDERS. Measuring sheets must be faxed to 1-330-399-4426 Attn: Custom Shower Doors or email to: showerdoors@mdcnw.com

Custom door orders can not be processed without receipt of the form. Custom Doors are not returnable.

Notched Panels: Panels can be notched per the measuring sheet for a \$120.00 upcharge to the price.

Steam Units: Steam units are available for Framed ProLine Custom units only (4600 Series Models) at a \$150.00 upcharge to the price.

STERLING® Custom Sliding Bath & Shower Doors

CUSTOM SLIDING BATH & SHOWER DOOR MEASURING SHEET 4600 & 4700 SERIES

Sample Measuring Sheet

Style TS8

Model # _____ (fill in from corresponding price page)

ECP Price \$ _____ P.O. # _____

Order Submitted By _____ Store # _____

Store Location _____

Number of Units Required _____

Delivery Address _____

(if different from above)

City _____ State _____ Zip _____

Your Customer Name _____

Your Customer's Phone No. _____

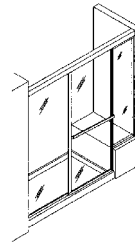

*Framed style shown.

Note: Glass panels are not the exact size of the opening. Allow for framing.

Step #1. Check door style

Framed (4600 Series) Check here if you require a steam unit. (framed models only \$150.00 upcharge.)

Frameless (4700 Series)
*For Frameless door style, only door panel(s) is/are frameless

Step #2. Check frame finish

Silver Nickel (Frameless only)

Matte Silver

Step #3. Check glass type desired:

(Please check one box only)



Pebbled

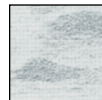

Hammered



Clear

Step #4. Measure installation area and fill in dimensions.

DIM W _____ DIM H _____
Door Width Height (from top of bath or threshold up)

DIM S _____ DIM R _____
Inline Panel Width (7"min/24"max) Wall Height
(from top of bath or threshold up)

DIM L _____
Total Width (W+S)

Bath Door: max. 72" width, max. 60" height
Shower Door: max. 60" width, max. 72" height
Inline Panel: min. 7"/max. 24" width

Not to exceed total width: Bath 96", Shower 96"

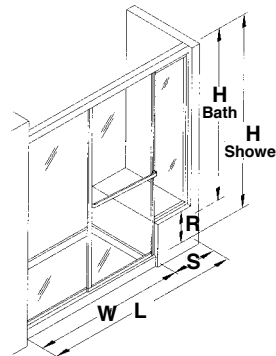

Step #5. If required, measure panel notches and fill in dimensions.

N _____ P _____ Notched on Right

O _____ Q _____ Notched on Left

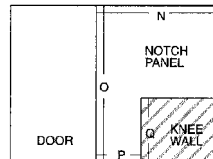

Note: Minimum notched panel dimensions = 4" x 4"
Notched panel must be at least 7" wide (measurement P) to prevent glass from breaking.

IMPORTANT: CUSTOM MEASURING SHEETS ARE REQUIRED TO PROCESS ALL CUSTOM DOOR ORDERS. Be sure to fill out completely and fax to 1-330-399-4426 attention Custom Shower Doors or email to showerdoors@mdcnw.com. Custom door orders can not be processed without receipt of the form. Custom doors are not returnable.

STERLING® Custom Sliding Bath & Shower Doors

STERLING® PROLINE® FRAMED STYLE TS9

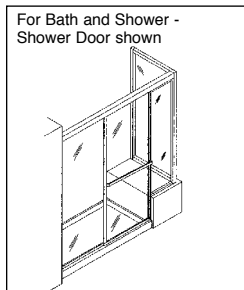

SPECIFICATIONS

SLIDING - 4600 SERIES - Style TS9

Bath Door Size: max. 72" width x max. 60" height Bath Door & Inline: max. 96"width
 Shower Door Size: max. 60" width x max. 72" height. Shower Door & Inline: max. 84"width
 Inline Panel: min. 7"/max. 24" width. Return Panel: min. 7"/max. 48" width.

Features: Proline® sliding framed bath or shower door with one inline panel on kneewall and one return panel on kneewall. Includes single towel bar.

Glass Thickness: 3/16"

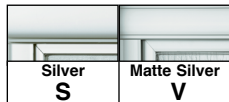

Note: Not to exceed total width: Bath 96", Shower 96"

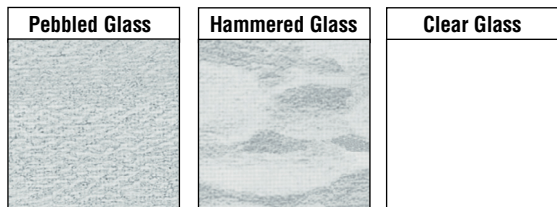

Model No.	Glass Pattern	Frame Finish			
		Silver	Matte Silver	Nickel	Deep Bronze
4600-9	Pebbled	\$1,673.00	\$1,791.50	N/A	N/A
4600-9	Hammered	\$1,673.00	\$1,791.50	N/A	N/A
4605-9	Clear	\$1,713.15	\$1,833.75	N/A	N/A

 **Custom Bath & Shower Doors.**
 Allow 6 weeks for delivery. Custom doors not returnable.

STERLING® PROLINE® FRAMELESS STYLE TS9

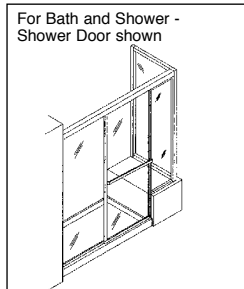

SPECIFICATIONS

SLIDING - 4700 SERIES - Style TS9

Bath Door Size: max. 72" width x max. 60" height Bath Door & Inline: max. 96"width
 Shower Door Size: max. 60" width x max. 72" height. Shower Door & Inline: max. 84"width
 Inline Panel: min. 7"/max. 24" width. Return Panel: min. 7"/max. 48" width

Features: Proline® sliding bath or shower door with one inline panel on kneewall and one return panel on kneewall. Features frameless glass panel door. Includes single towel bar.

Glass Thickness: Frameless Doors with Clear glass are 1/4", all others 3/16"



Note: Not to exceed total width: Bath 96", Shower 96"

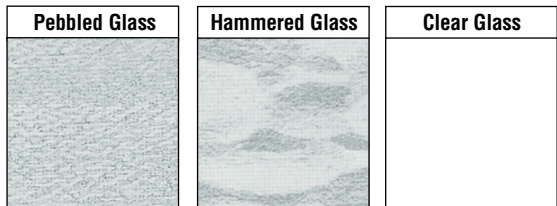

Model No.	Glass Pattern	Frame Finish			
		Silver	Matte Silver	Nickel	Deep Bronze
4700-9	Pebbled	\$1,748.30	\$1,870.40	\$1,806.30	N/A
4700-9	Hammered	\$1,748.30	\$1,870.40	\$1,806.30	N/A
4705-9	Clear	\$1,789.35	\$1,911.95	\$1,846.45	N/A

 **Custom Bath & Shower Doors.**
 Allow 6 weeks for delivery. Custom doors not returnable.

NOTES:

CUSTOM MEASURING SHEETS ARE REQUIRED TO PROCESS ALL CUSTOM DOOR ORDERS. Measuring sheets must be faxed to 1-330-399-4426 Attn: Custom Shower Doors or email to: showerdoors@mdcnw.com

Custom door orders can not be processed without receipt of the form. Custom Doors are not returnable.

Notched Panels: Panels can be notched per the measuring sheet for a \$120.00 upcharge to the price.

Steam Units: Steam units are available for Framed ProLine Custom units only (4600 Series Models) at a \$150.00 upcharge to the price.

STERLING® Custom Sliding Bath & Shower Doors

CUSTOM SLIDING BATH & SHOWER DOOR MEASURING SHEET 4600 & 4700 SERIES

Sample Measuring Sheet

Style TS9

Model # _____ (fill in from corresponding price page)

ECP Price \$ _____ P.O. # _____

Order Submitted By _____ Store # _____

Store Location _____

Number of Units Required _____

Delivery Address _____

(if different from above)

City _____ State _____ Zip _____

Your Customer Name _____

Your Customer's Phone No. _____

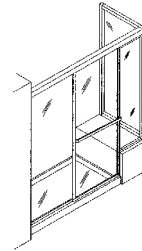

*Framed style shown.

Note: Glass panels are not the exact size of the opening. Allow for framing.

Step #1. Check door style

Framed (4600 Series) Check here if you require a steam unit. (framed models only \$150.00 upcharge.)

Frameless (4700 Series)
*For Frameless door style, only door panel(s) is/are frameless

Step #2. Designate return panel.

Right

Left

Step #3. Check frame finish

Silver Nickel (Frameless only)

Matte Silver

Step #4. Check glass type desired: (Please check one box only)



Pebbled

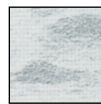

Hammered



Clear

Step #5. Measure installation area and fill in dimensions.

DIM W _____ DIM H _____
Door Width Height (from top of bath or threshold up)

DIM S _____ DIM E _____
Inline Panel Width (7"min/24"max) Return Panel Width (7"min/48"max)

DIM L _____ DIM R _____
Total Width (W+S) Wall Height (from top of bath or threshold up)

Bath Door: max. 72" width, max. 60" height
Shower Door: max. 60" width, max. 72" height
Inline Panel: min. 7"/max. 24" width
Return Panel: min. 7"/max. 48" width

Not to exceed total width: Bath 96", Shower 96"

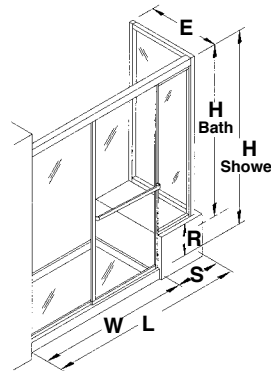

Step #6. If required, measure panel notches and fill in dimensions.

N _____ P _____ Notched on Right

O _____ Q _____ Notched on Left

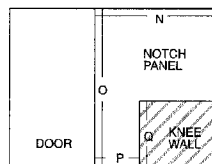

Note: Minimum notched panel dimensions = 4" x 4"
Notched panel must be at least 7" wide (measurement P) to prevent glass from breaking.

IMPORTANT: CUSTOM MEASURING SHEETS ARE REQUIRED TO PROCESS ALL CUSTOM DOOR ORDERS. Be sure to fill out completely and fax to 1-330-399-4426 attention Custom Shower Doors or email to showerdoors@mdcnw.com. Custom door orders can not be processed without receipt of the form. Custom doors are not returnable.

STERLING® Custom Neo Angle Shower Doors

STERLING® PROLINE® FRAMED STYLE N1

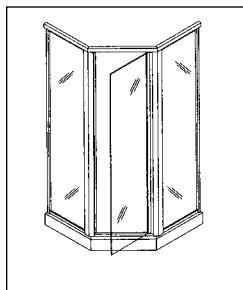

SPECIFICATIONS

NEO-ANGLE - 4800 SERIES - Style N1

Total Size: 90" or less width. Max. 84" height

Door: max: 36" width. Fixed Panel: max. 48" width

Features: Proline® Neo-Angle Framed Shower Door with two full length fixed glass panels - sum of door and fixed panel width = 90" or less¹. Includes full length handle, no towel bar.

Glass Thickness: 3/16"

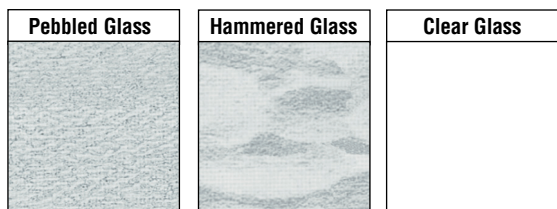
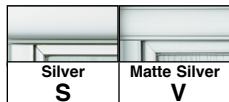

Model No.	Glass Pattern	Frame Finish			
		Silver	Matte Silver	Nickel	Deep Bronze
4800-N1-90	Pebbled	\$1,579.50	\$1,683.90	N/A	N/A
4800-N1-90	Hammered	\$1,579.50	\$1,683.90	N/A	N/A
4805-N1-90	Clear	\$1,617.80	\$1,708.75	N/A	N/A

 **Custom Bath & Shower Doors.**
Allow 6 weeks for delivery. Custom doors not returnable.

STERLING® PROLINE® FRAMELESS STYLE N1

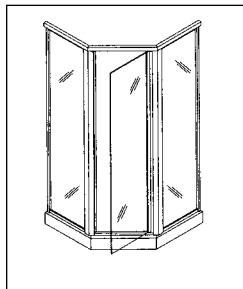

SPECIFICATIONS

NEO-ANGLE - 4900 SERIES - Style N1

Total Size: 90" or less width. Max. 84" height

Door: max: 36" width. Fixed Panel: max. 48" width

Features: Proline® Neo-Angle Shower Door features frameless glass panel door and two full length fixed glass panels - sum of door and fixed panel width = 90" or less¹. Includes single round towel bar.

Glass Thickness: Frameless Doors with Clear glass are 1/4", all others 3/16"

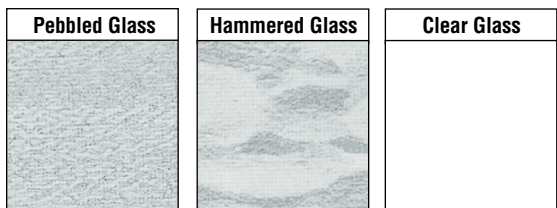

Model No.	Glass Pattern	Frame Finish			
		Silver	Matte Silver	Nickel	Deep Bronze
4900-N1-90	Pebbled	\$1,665.30	\$1,766.35	\$1,788.40	N/A
4900-N1-90	Hammered	\$1,665.30	\$1,766.35	\$1,788.40	N/A
4905-N1-90	Clear	\$1,728.30	\$1,832.75	\$1,788.40	N/A

 **Custom Bath & Shower Doors.**
Allow 6 weeks for delivery. Custom doors not returnable.

¹For Neo-Angle Doors greater than 90" width, up to a maximum of 110" - add \$66.00 to the price.

CUSTOM MEASURING SHEETS ARE REQUIRED TO PROCESS ALL CUSTOM DOOR ORDERS. Measuring sheets must be faxed to 1-330-399-4426 Attn: Custom Shower Doors or email to: showerdoors@mdcnow.com

Custom door orders can not be processed without receipt of the form. Custom Doors are not returnable.

Notched Panels: Panels can be notched per the measuring sheet for a \$120.00 upcharge to the price.

Steam Units: Steam units are available for Framed ProLine Custom units only (4800 Series Models) at a \$150.00 upcharge to the price.

STERLING® Custom Neo Angle Shower Doors

CUSTOM NEO-ANGLE SHOWER DOOR MEASURING SHEET

4800 & 4900 SERIES

Sample Measuring Sheet

Style N1

Model # _____ (fill in from corresponding price page)
 ECP Price \$ _____ P.O. # _____
 Order Submitted By _____ Store # _____
 Store Location _____
 Number of Units Required _____
 Delivery Address _____
 (if different from above)
 City _____ State _____ Zip _____
 Your Customer Name _____
 Your Customer's Phone No. _____

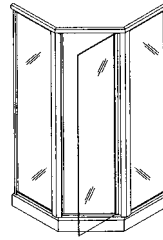

*Framed style shown.

Note: Glass panels are not the exact size of the opening. Allow for framing.

Step #1. Check door position

A B C

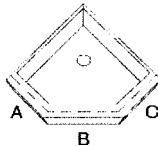

Step #2. Check door style

Framed (4800 Series) Check here if you require a steam unit. (framed models only \$150.00 upcharge.)
 Frameless (4900 Series)
**For Frameless door style, only door panel(s) is/are frameless*

Step #3. Check frame finish

Silver Nickel (Frameless only)
 Matte Silver

Step #4. Check glass type desired: (Please check one box only)



Pebbled

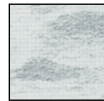

Hammered



Clear

Step #5. Measure installation area and fill in centerline dimensions.

If inline panel is required with door section, designate:
 door width _____ and inline panel width _____
 (door panel = 36" max; side panel(s) = 6" min.).

DIM A _____ DIM H _____
 Panel Height (from threshold up)
 DIM B _____
 Panel
 DIM C _____
 Panel

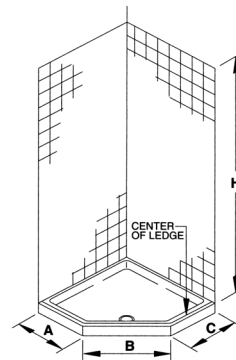

Door: max. 36" width
 Fixed Panel: max. 48" width
 Sum of door and fixed panel width = 90" or less;
 Greater than 90" width, up to maximum 110" = \$66.00 upcharge
 Maximum 84" height

Note: All dimensions taken at centerline of ledge/threshold

IMPORTANT: CUSTOM MEASURING SHEETS ARE REQUIRED TO PROCESS ALL CUSTOM DOOR ORDERS. Be sure to fill out completely and fax to 1-330-399-4426 attention Custom Shower Doors or email to showerdoors@mdcnw.com. Custom door orders can not be processed without receipt of the form. Custom doors are not returnable.

STERLING® Custom Neo Angle Shower Doors

STERLING® PROLINE® FRAMED STYLE N2

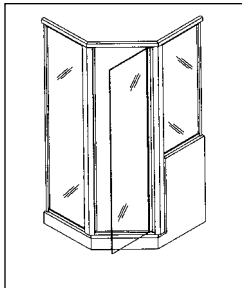

SPECIFICATIONS

NEO-ANGLE - 4800 SERIES - Style N2

Total Size: 90" or less width. Max. 84" height

Door: max: 36" width. Fixed Panel: max. 48" width

Features: Proline® Neo-Angle Framed Shower Door with one full length fixed glass panel and one fixed glass panel on a step up wall - sum of door and fixed panel width = 90" or less¹.

Includes full length handle, no towel bar.

Glass Thickness: Framed Doors with Moraine, Naturalist, Solstice glass are 5/32", all others 3/16"

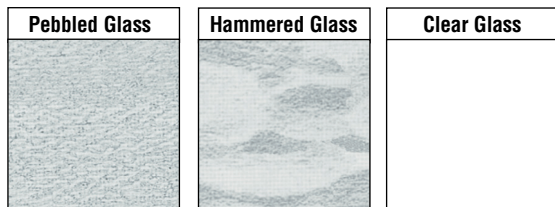
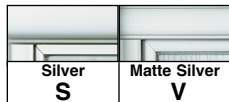

Model No.	Glass Pattern	Frame Finish			
		Silver	Matte Silver	Nickel	Deep Bronze
4800-N2-90	Pebbled	\$1,511.60	\$1,778.60	N/A	N/A
4800-N2-90	Hammered	\$1,511.60	\$1,778.60	N/A	N/A
4805-N2-90	Clear	\$1,546.65	\$1,639.05	N/A	N/A

 **Custom Bath & Shower Doors.**
Allow 6 weeks for delivery. Custom doors not returnable.

STERLING® PROLINE® FRAMELESS STYLE N2

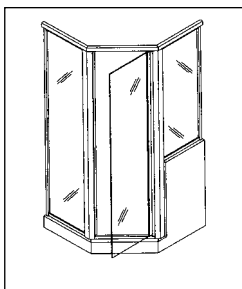

SPECIFICATIONS

NEO-ANGLE - 4900 SERIES - Style N2

Total Size: 90" or less width. Max. 84" height

Door: max: 36" width. Fixed Panel: max. 48" width

Features: Proline® Neo-Angle Shower Door features frameless glass panel door with one full length fixed glass panel and one fixed glass panel on a step up wall - sum of door and fixed panel width = 90" or less¹. Includes single round towel bar.

Glass Thickness: Frameless Doors with Clear glass are 1/4", all others 3/16"

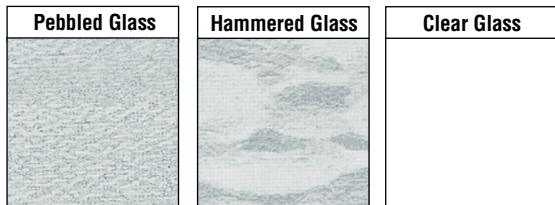

Model No.	Glass Pattern	Frame Finish			
		Silver	Matte Silver	Nickel	Deep Bronze
4900-N2-90	Pebbled	\$1,595.05	\$1,766.20	\$1,654.25	N/A
4900-N2-90	Hammered	\$1,595.05	\$1,766.20	\$1,654.25	N/A
4905-N2-90	Clear	\$1,657.60	\$1,768.30	\$1,715.15	N/A

 **Custom Bath & Shower Doors.**
Allow 6 weeks for delivery. Custom doors not returnable.

¹For Neo-Angle Doors greater than 90" width, up to a maximum of 110" - add \$66.00 to the price.

CUSTOM MEASURING SHEETS ARE REQUIRED TO PROCESS ALL CUSTOM DOOR ORDERS. Measuring sheets must be faxed to 1-330-399-4426 Attn: Custom Shower Doors or email to: showerdoors@mdcnw.com

Custom door orders can not be processed without receipt of the form. Custom Doors are not returnable.

Notched Panels: Panels can be notched per the measuring sheet for a \$120.00 upcharge to the price.

Steam Units: Steam units are available for Framed ProLine Custom units only (4800 Series Models) at a \$150.00 upcharge to the price.

STERLING® Custom Neo Angle Shower Doors

CUSTOM NEO-ANGLE SHOWER DOOR MEASURING SHEET 4800 & 4900 SERIES

Sample Measuring Sheet

Style N2

Model # _____ (fill in from corresponding price page)

ECP Price \$ _____ P.O. # _____

Order Submitted By _____ Store # _____

Store Location _____

Number of Units Required _____

Delivery Address _____
(if different from above)

City _____ State _____ Zip _____

Your Customer Name _____

Your Customer's Phone No. _____

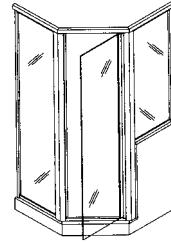

Framed* style shown.

Note: Glass panels are not the exact size of the opening. Allow for framing.

Step #1. Circle desired layout, and door and knee position.

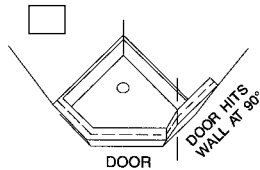
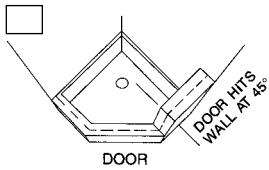

Check door position

A B C

Check knee wall position

A C

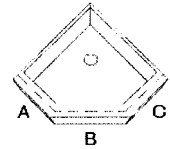

Step #2. Check door style

Framed (4800 Series) Check here if you require a steam unit. (framed models only \$150.00 upcharge.)

Frameless (4900 Series)
**For Frameless door style, only door panel(s) is/are frameless*

Step #3. Check frame finish

Silver Nickel (Frameless only)
 Matte Silver

Step #4. Check glass type desired: (Please check one box only)

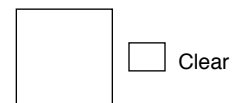

Step #5. Measure installation area and fill in centerline dimensions.

If inline panel is required with door section, designate:
door width _____ and inline panel width _____
(door panel = 36" max; side panel(s) = 6" min.).

DIM A _____ DIM H _____
Panel Height (from threshold up)

DIM B _____ DIM T _____
Panel Wall Height (from threshold up)

DIM C _____
Panel

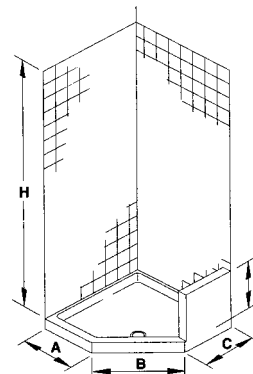

Door: max. 36" width
Fixed Panel: max. 48" width
Sum of door and fixed panel width = 90" or less;
Greater than 90" width, up to maximum 110" = \$66.00 upcharge
Maximum 84" height

Note: All dimensions taken at centerline of ledge/threshold

IMPORTANT: CUSTOM MEASURING SHEETS ARE REQUIRED TO PROCESS ALL CUSTOM DOOR ORDERS. Be sure to fill out completely and fax to 1-330-399-4426 attention Custom Shower Doors or email to showerdoors@mdcnw.com. Custom door orders can not be processed without receipt of the form. Custom doors are not returnable.

STERLING® Custom Neo Angle Shower Doors

STERLING® PROLINE® FRAMED STYLE N3

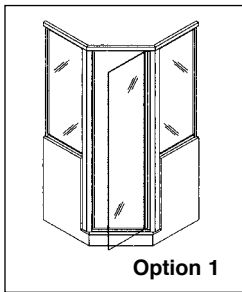

SPECIFICATIONS

NEO-ANGLE - 4800 SERIES - Style N3

Total Size: 90" or less width. Max. 84" height

Door: max: 36" width. Fixed Panel: max. 48" width

Features: Proline® Neo-Angle Framed Shower Door with two fixed glass panels on step-up walls - sum of door & fixed panel width = 90" or less¹. Includes full length handle, no towel bar. Layout Option 1: Fixed glass panels on opposite walls.

Layout Option 2: Fixed glass panels on adjacent walls.

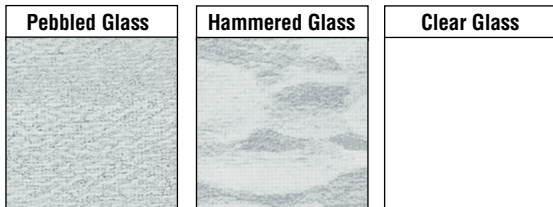
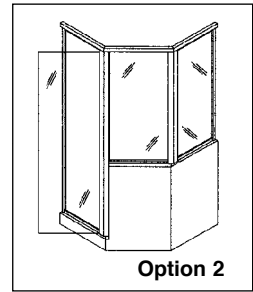

Model No.	Glass Pattern	Frame Finish			
		Silver	Matte Silver	Nickel	Deep Bronze
4800-N3-90	Pebbled	\$1,456.05	\$1,559.70	N/A	N/A
4800-N3-90	Hammered	\$1,456.05	\$1,559.70	N/A	N/A
4805-N3-90	Clear	\$1,541.35	\$1,597.05	N/A	N/A

 **Custom Bath & Shower Doors.**
Allow 6 weeks for delivery. Custom doors not returnable.

STERLING® PROLINE® FRAMELESS STYLE N3

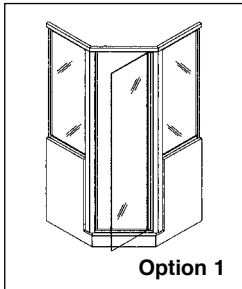

SPECIFICATIONS

NEO-ANGLE - 4900 SERIES - Style N3

Total Size: 90" or less width. Max. 84" height

Door: max: 36" width. Fixed Panel: max. 48" width

Features: Proline® Neo-Angle Shower Door features frameless glass panel door and two fixed glass panels on step-up walls - sum of door & fixed panel width = 90" or less¹. Includes single round towel bar. Layout Option 1: Fixed glass panels on opposite walls.

Layout Option 2: Fixed glass panels on adjacent walls.

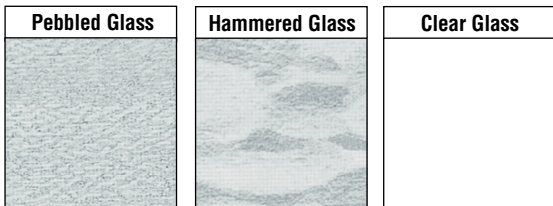
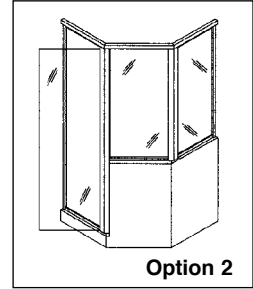

Model No.	Glass Pattern	Frame Finish			
		Silver	Matte Silver	Nickel	Deep Bronze
4900-N3-90	Pebbled	\$1,547.55	\$1,592.15	\$1,611.85	N/A
4900-N3-90	Hammered	\$1,547.55	\$1,592.15	\$1,611.85	N/A
4905-N3-90	Clear	\$1,609.55	\$1,719.75	\$1,670.15	N/A

 **Custom Bath & Shower Doors.**
Allow 6 weeks for delivery. Custom doors not returnable.

¹For Neo-Angle Doors greater than 90" width, up to a maximum of 110" - add \$66.00 to the price.

CUSTOM MEASURING SHEETS ARE REQUIRED TO PROCESS ALL CUSTOM DOOR ORDERS. Measuring sheets must be faxed to 1-330-399-4426 Attn: Custom Shower Doors or email to: showerdoors@mdcnw.com

Custom door orders can not be processed without receipt of the form. Custom Doors are not returnable.

Notched Panels: Panels can be notched per the measuring sheet for a \$120.00 upcharge to the price.

Steam Units: Steam units are available for Framed ProLine Custom units only (4800 Series Models) at a \$150.00 upcharge to the price.

STERLING® Custom Neo Angle Shower Doors

CUSTOM NEO-ANGLE SHOWER DOOR MEASURING SHEET 4800 & 4900 SERIES

Sample Measuring Sheet

Style N3

Model # _____ (fill in from corresponding price page)

ECP Price \$ _____ P.O. # _____

Order Submitted By _____ Store # _____

Store Location _____

Number of Units Required _____

Delivery Address _____
(if different from above)
City _____ State _____ Zip _____

Your Customer Name _____

Your Customer's Phone No. _____

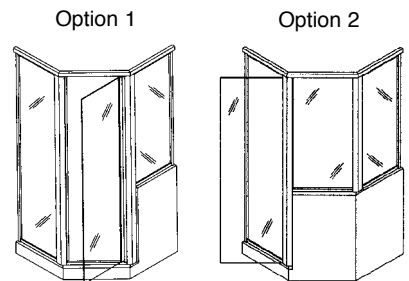

*Framed styles shown (see previous page for layout options).

Note: Glass panels are not the exact size of the opening. Allow for framing.

Step #1. Circle desired layout. Option 1 only:

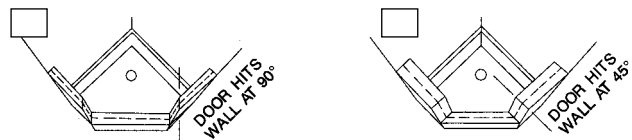

Step #1. Circle desired layout, and door position. Option 2 only:

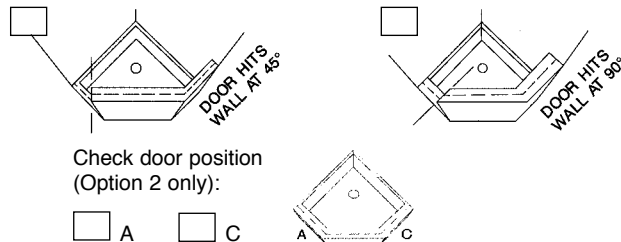

Step #2. Check door style

- Framed (4800 Series) Check here if you require a steam unit. (framed models only \$150.00 upcharge.)
- Frameless (4900 Series)
*For Frameless door style, only door panel(s) is/are frameless

Step #3. Check frame finish

- Silver Nickel (Frameless only)
- Matte Silver

Step #4. Check glass type desired:
(Please check one box only)



Step #5. Measure installation area and fill in centerline dimensions.

If inline panel is required with door section, designate:
door width _____ and inline panel width _____
(door panel = 36" max; side panel(s) = 6" min.).

DIM A _____ Panel
DIM B _____ Panel
DIM C _____ Panel

DIM H _____ Height (from threshold up)
DIM R _____ Wall Height (from threshold up)
DIM T _____ Wall Height (from threshold up)

Door: max. 36" width
Fixed Panel: max. 48" width
Sum of door and fixed panel width = 90" or less;
Greater than 90" width, up to maximum 110" = \$66.00 upcharge
Maximum 84" height

Option 1 shown

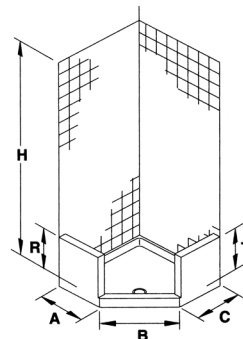

Option 2 shown

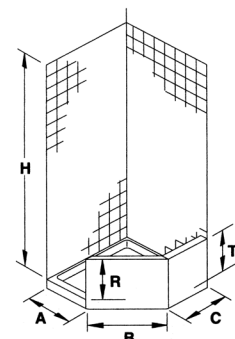

Note: All dimensions taken at centerline of ledge/threshold

IMPORTANT: CUSTOM MEASURING SHEETS ARE REQUIRED TO PROCESS ALL CUSTOM DOOR ORDERS. Be sure to fill out completely and fax to 1-330-399-4426 attention Custom Shower Doors or email to showerdoors@mdcnw.com. Custom door orders can not be processed without receipt of the form. Custom doors are not returnable.

STERLING® Custom Neo Angle Shower Doors

STERLING® KOHLER CORPORATION PROLINE® FRAMED STYLE N4

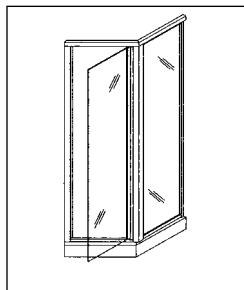

SPECIFICATIONS

NEO-ANGLE - 4800 SERIES - Style N4

Total Size: 90" or less width. Max. 84" height

Door: max: 36" width. Fixed Panel: max. 48" width

Features: Proline® 2/3 Neo-Angle Framed Shower Door with one full length fixed glass panel - sum of door and fixed panel width = 64" or less². Includes full length handle, no towel bar.

Glass Thickness: 3/16"

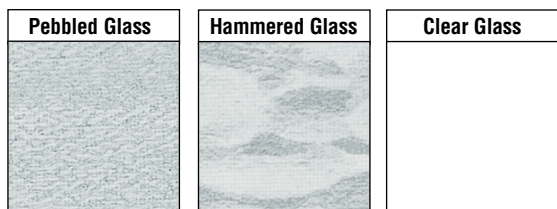
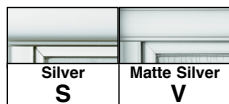

Model No.	Glass Pattern	Frame Finish			
		Silver	Matte Silver	Nickel	Deep Bronze
4800-N4-64	Pebbled	\$1,304.65	N/A	N/A	N/A
4800-N4-64	Hammered	\$1,304.65	N/A	N/A	N/A
4805-N4-64	Clear	\$1,347.30	N/A	N/A	N/A

 **Custom Bath & Shower Doors.**
Allow 6 weeks for delivery. Custom doors not returnable.

STERLING® KOHLER CORPORATION PROLINE® FRAMELESS STYLE N4

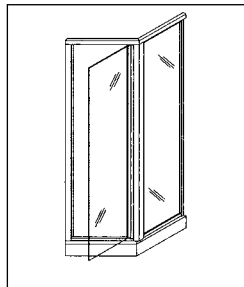

SPECIFICATIONS

NEO-ANGLE - 4900 SERIES - Style N4

Total Size: 90" or less width. Max. 84" height

Door: max: 36" width. Fixed Panel: max. 48" width

Features: Proline® Neo-Angle Shower Door features frameless glass panel door and one full length fixed glass panel - sum of door & fixed panel width = 64" or less². Includes single round towel bar.

Glass Thickness: Frameless Doors with Clear glass are 1/4", all others 3/16"

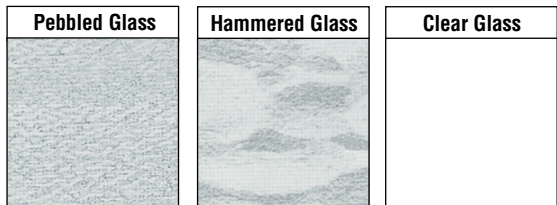

Model No.	Glass Pattern	Frame Finish			
		Silver	Matte Silver	Nickel	Deep Bronze
4900-N4-64	Pebbled	N/A	N/A	\$1,488.20	N/A
4900-N4-64	Hammered	N/A	N/A	\$1,488.20	N/A
4905-N4-64	Clear	N/A	N/A	\$1,526.35	N/A

 **Custom Bath & Shower Doors.**
Allow 6 weeks for delivery. Custom doors not returnable.

¹For Neo-Angle Doors greater than 90" width, up to a maximum of 110" - add \$66.00 to the price.

CUSTOM MEASURING SHEETS ARE REQUIRED TO PROCESS ALL CUSTOM DOOR ORDERS. Measuring sheets must be faxed to 1-330-399-4426 Attn: Custom Shower Doors or email to: showerdoors@mdcnw.com

Custom door orders can not be processed without receipt of the form. Custom Doors are not returnable.

Notched Panels: Panels can be notched per the measuring sheet for a \$120.00 upcharge to the price.

Steam Units: Steam units are available for Framed ProLine Custom units only (4800 Series Models) at a \$150.00 upcharge to the price.

STERLING® Custom Neo Angle Shower Doors

CUSTOM NEO-ANGLE SHOWER DOOR MEASURING SHEET 4800 & 4900 SERIES

Sample Measuring Sheet Style N4

Model # _____ (fill in from corresponding price page)
 ECP Price \$ _____ P.O. # _____
 Order Submitted By _____ Store # _____
 Store Location _____
 Number of Units Required _____
 Delivery Address _____
 (if different from above)
 City _____ State _____ Zip _____
 Your Customer Name _____
 Your Customer's Phone No. _____

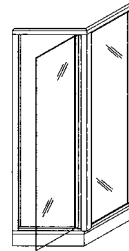

*Framed style shown.

Note: Glass panels are not the exact size of the opening. Allow for framing.

Step #1. Circle desired layout, and kneewall or door position.

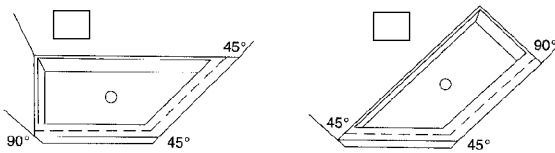

Check door position

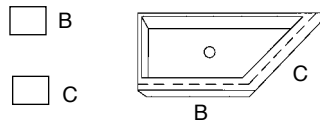

Step #2. Check door style

Framed (4800 Series) Check here if you require a steam unit. (framed models only \$150.00 upcharge.)
 Frameless (4900 Series)
**For Frameless door style, only door panel(s) is/are frameless*

Step #3. Check frame finish

Silver Nickel (Frameless only)
 Matte Silver

Step #4. Check glass type desired:
 (Please check one box only)

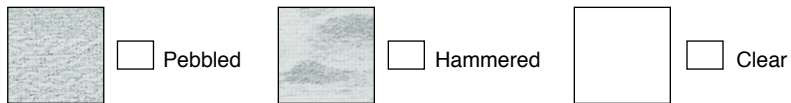

Step #5. Measure installation area and fill in centerline dimensions.

If inline panel is required with door section, designate:
 door width _____ and inline panel width _____
 (door panel = 36" max; side panel(s) = 6" min.).

DIM B _____ DIM H _____
 Panel Height (from threshold up)
 DIM C _____
 Panel

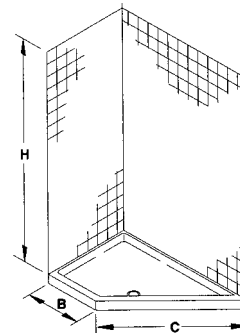

Door: max. 36" width
Fixed Panel: max. 48" width
Sum of door and fixed panel width = 64" or less;
Greater than 64" width, up to maximum 80" = \$66.00 upcharge
Maximum 84" height

Note: All dimensions taken at centerline of ledge/threshold

IMPORTANT: CUSTOM MEASURING SHEETS ARE REQUIRED TO PROCESS ALL CUSTOM DOOR ORDERS. Be sure to fill out completely and fax to 1-330-399-4426 attention Custom Shower Doors or email to showerdoors@mdcnw.com. Custom door orders can not be processed without receipt of the form. Custom doors are not returnable.

STERLING® Custom Neo Angle Shower Doors



PROLINE® FRAMED STYLE N5

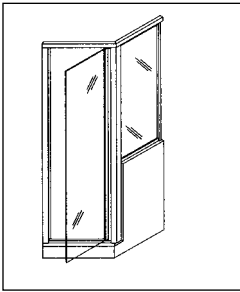

SPECIFICATIONS

NEO-ANGLE - 4800 SERIES - Style N5
 Total Size: 90" or less width. Max. 84" height
 Door: max: 36" width. Fixed Panel: max. 48" width
 Features: Proline® 2/3 Neo-Angle Framed Shower Door with one fixed glass panel on a step up wall - sum of door and fixed panel width = 64" or less². Includes full length handle, no towel bar.
 Glass Thickness: 3/16"

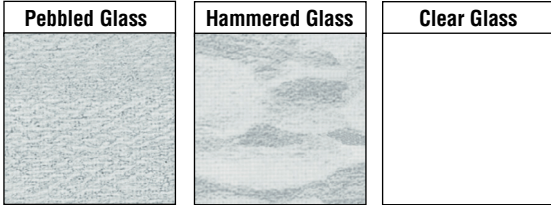

Model No.	Glass Pattern	Frame Finish			
		Silver	Matte Silver	Nickel	Deep Bronze
4800-N5-64	Pebbled	\$1,264.05	\$1,361.00	N/A	N/A
4800-N5-64	Hammered	\$1,264.05	\$1,361.00	N/A	N/A
4805-N5-64	Clear	\$1,299.90	\$1,361.05	N/A	N/A

 **Custom Bath & Shower Doors.**
 Allow 6 weeks
 for delivery. Custom
 doors not returnable.



PROLINE® FRAMELESS STYLE N5

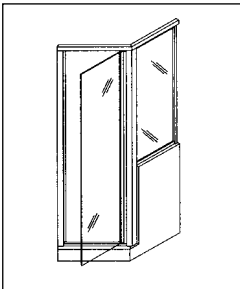

SPECIFICATIONS

NEO-ANGLE - 4900 SERIES - Style N5
 Total Size: 90" or less width. Max. 84" height
 Door: max: 36" width. Fixed Panel: max. 48" width
 Features: Proline® Neo-Angle Shower Door features frameless glass panel door and one fixed glass panel on a step up wall - sum of door & fixed panel width = 64" or less². Includes single round towel bar.
 Glass Thickness: Frameless Doors with Clear glass are 1/4", all others

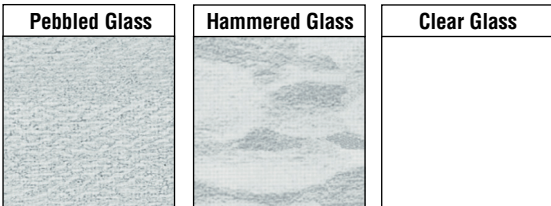

Model No.	Glass Pattern	Frame Finish			
		Silver	Matte Silver	Nickel	Deep Bronze
4900-N5-64	Pebbled	\$1,431.35	\$1,461.35	\$1,461.35	N/A
4900-N5-64	Hammered	\$1,431.35	\$1,461.35	\$1,461.35	N/A
4905-N5-64	Clear	\$1,465.90	\$1,495.90	\$1,513.75	N/A

 **Custom Bath & Shower Doors.**
 Allow 6 weeks
 for delivery. Custom
 doors not returnable.

¹For Neo-Angle Doors greater than 90" width, up to a maximum of 110" - add \$66.00 to the price.

CUSTOM MEASURING SHEETS ARE REQUIRED TO PROCESS ALL CUSTOM DOOR ORDERS. Measuring sheets must be faxed to 1-330-399-4426 Attn: Custom Shower Doors or email to: showerdoors@mdcnow.com

Custom door orders can not be processed without receipt of the form. Custom Doors are not returnable.

Notched Panels: Panels can be notched per the measuring sheet for a \$120.00 upcharge to the price.

Steam Units: Steam units are available for Framed ProLine Custom units only (4800 Series Models) at a \$150.00 upcharge to the price.

STERLING® Custom Neo Angle Shower Doors

CUSTOM NEO-ANGLE SHOWER DOOR MEASURING SHEET 4800 & 4900 SERIES

Sample Measuring Sheet

Style N5

Model # _____ (fill in from corresponding price page)

ECP Price \$ _____ P.O. # _____

Order Submitted By _____ Store # _____

Store Location _____

Number of Units Required _____

Delivery Address _____

(if different from above)
City _____ State _____ Zip _____

Your Customer Name _____

Your Customer's Phone No. _____

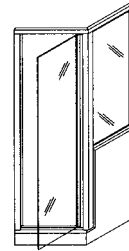

*Framed style shown.

Note: Glass panels are not the exact size of the opening. Allow for framing.

Step #1. Circle desired layout, and kneewall or door position.

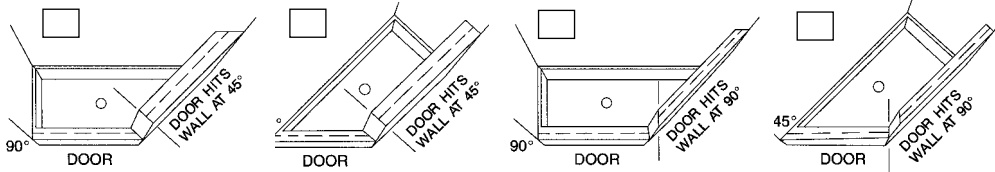

Check knee wall position

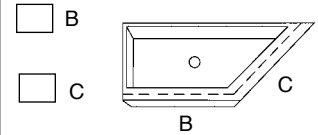

Step #2. Check door style

- Framed (4800 Series) Check here if you require a steam unit. (framed models only \$150.00 upcharge.)
- Frameless (4900 Series)
*For Frameless door style, only door panel(s) is/are frameless

Step #3. Check frame finish

- Silver Nickel (Frameless only)
- Matte Silver

Step #4. Check glass type desired:
(Please check one box only)

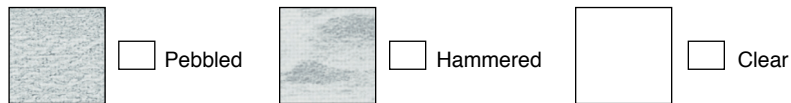

Step #5. Measure installation area and fill in centerline dimensions.

If inline panel is required with door section, designate:
door width _____ and inline panel width _____
(door panel = 36" max; side panel(s) = 6" min.).

DIM B _____ DIM H _____
Panel Height (from threshold up)

DIM C _____ DIM R _____
Panel Wall Height (from threshold up)

Door: max. 36" width
Fixed Panel: max. 48" width
Sum of door and fixed panel width = 64" or less;
Greater than 64" width, up to maximum 80" = \$66.00 upcharge
Maximum 84" height

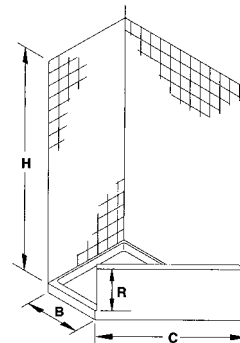

Note: All dimensions taken at centerline of ledge/threshold

IMPORTANT: CUSTOM MEASURING SHEETS ARE REQUIRED TO PROCESS ALL CUSTOM DOOR ORDERS. Be sure to fill out completely and fax to 1-330-399-4426 attention Custom Shower Doors or email to showerdoors@mdcnw.com. Custom door orders can not be processed without receipt of the form. Custom doors are not returnable.

STERLING® Custom Bath & Shower Door Order Forms



STERLING®

A KOHLER COMPANY

ProLine® Custom Doors

Available in sliding, pivot and neo-angle configurations

Custom Sliding Framed Shower Door with Inline Panel 4600-S3
with silver frame and pebbled glass. TS3 style shown

2016 899-0100