

**PRODUCT SPECIFICATIONS**

Lustertone® Classic Stainless Steel 33" x 22" x 10" Single Bowl Drop-in Sink with Perfect Drain®. Sink is manufactured from 18 gauge 304 Stainless Steel with a Lustrous Satin finish, Center drain placement, and Bottom only pads.

<b>Installation Type:</b>	Drop-in
<b>Material:</b>	304 Stainless Steel
<b>Special Features:</b>	Perfect Drain
<b>Finish:</b>	Lustrous Satin
<b>Gauge:</b>	18
<b>Sound Deadening:</b>	Bottom only pads
<b>Number of Bowls:</b>	1
<b>Sink Dimensions:</b>	33" x 22" x 10"
<b>Bowl 1 Dimensions:</b>	28" x 16" x 10"
<b>Drain Size:</b>	3-3/8" (86mm)
<b>Drain Location:</b>	Center
<b>Minimum Cabinet Size:</b>	36"
<b>Mounting Hardware:</b>	Part # 64090012 included for countertops up to 3/4" (19mm) thick
<b>Template Included:</b>	No
<b>Cutout Template #:</b>	<a href="#">1000001189</a>

Template is available for download at [elkay.com](#). CAD software will be required to open the template.

**Cutout Dimensions for Drop-in Installation:**  
32-3/8" x 21-3/8" (822mm x 543mm) with 1-1/2" (38mm) corner radius

**Perfect Drain:** Seamlessly welded stainless steel collar eliminates the gap between a traditional drain and the sink for a more sanitary and gap free installation. Select garbage disposers can be installed on either sink bowl for user convenience. Please see our Garbage Disposer Compatibility Guide.

**Hole Drilling Configurations:**

1-1/2" (38mm) Diameter Faucet Holes on 4" (102mm) Centers

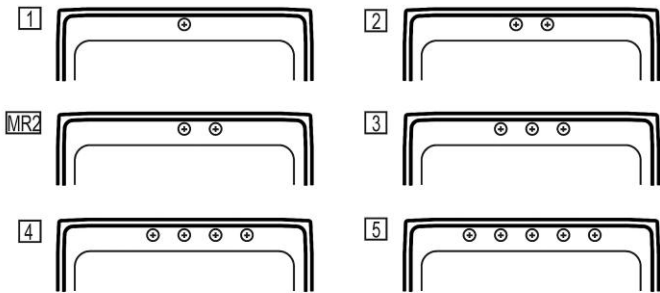

PART: \_\_\_\_\_ QTY: \_\_\_\_\_  
 PROJECT: \_\_\_\_\_  
 CONTACT: \_\_\_\_\_  
 DATE: \_\_\_\_\_  
 NOTES: \_\_\_\_\_  
 APPROVAL: \_\_\_\_\_



**Included with Product:** One LKPD1 Perfect Drain and strainer.

A Century of Tradition and Quality. For more than 100 years, Elkay has been making innovative products and providing exceptional customer care. We take pride in offering plumbing products that make life easier, inspire change and leave the world a better place.



**Product Compliance:** ASME A112.19.3/CSA B45.4  
**Accessory:** ASME A112.18.2/CSA B125.2

Sinks are listed by IAPMO® as meeting the applicable requirements of the Uniform Plumbing Code®, International Plumbing Code®, and National Plumbing Code of Canada.



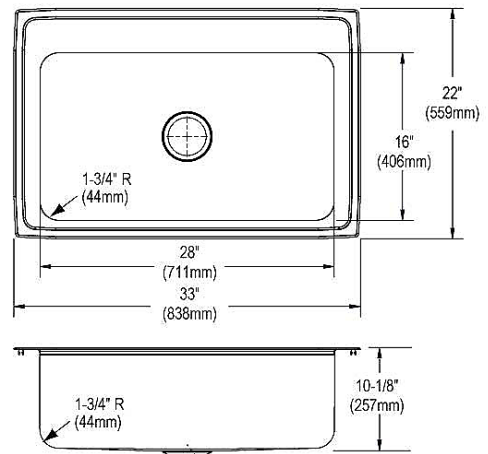

- [Clean and Care Manual \(PDF\)](#)
- [Installation Instructions \(PDF\) - 1000005236](#)
- [Installation Instructions \(PDF\) - 74180289 Disposer](#)
- [Installation Instructions \(PDF\) - 74180340-USA Drain](#)
- [Installation Instructions \(PDF\) - Garbage Disposer Compatibility Guide](#)
- [Warranty \(PDF\)](#)



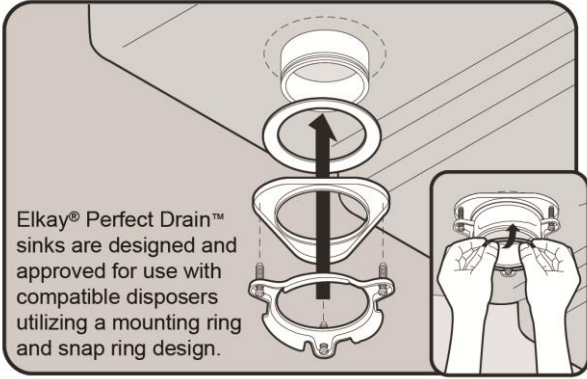
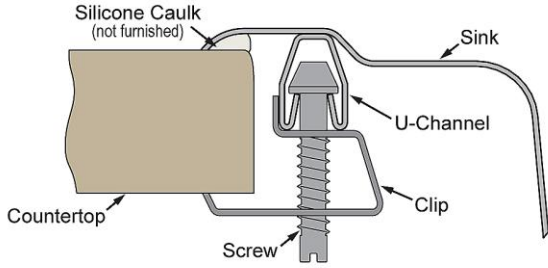

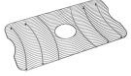

*In keeping with our policy of continuing product improvement, Elkay reserves the right to change product specifications without notice. Please visit [elkay.com](#) for the most current version of Elkay product specification sheets. This specification describes an Elkay product with design, quality, and functional benefits to the user. When making a comparison of other producers' offerings, be certain these features are not overlooked. Latest version of the spec sheet available: [https://www.elkayfiles.com/spec-sheets/DLRS332210PD\\_spec.pdf](https://www.elkayfiles.com/spec-sheets/DLRS332210PD_spec.pdf)*

**Installation Profile:**



Included Accessories		
<a href="#">LKPD1</a>	Perfect Drain® Fitting Type 304 Stainless Steel Body and Strainer <a href="#">Spec Sheet (PDF)</a>	
Optional Accessories		
<a href="#">LKWBG2816SS</a>	Stainless Steel 26-1/2" x 14-13/16" x 1" Bottom Grid <a href="#">Spec Sheet (PDF)</a>	
<a href="#">CB1713</a>	Hardwood 13-1/2" x 17" x 1" Cutting Board <a href="#">Spec Sheet (PDF)</a>	
<a href="#">CBS1316</a>	Hardwood 14-1/2" x 17" x 3/4" Cutting Board <a href="#">Spec Sheet (PDF)</a>	
<a href="#">LKDS35</a>	3-1/2" Garbage Disposal Stopper / Strainer for use with Perfect Drain®-Satin Finish <a href="#">Spec Sheet (PDF)</a>	

In keeping with our policy of continuing product improvement, Elkay reserves the right to change product specifications without notice. Please visit [elkay.com](http://elkay.com) for the most current version of Elkay product specification sheets. This specification describes an Elkay product with design, quality, and functional benefits to the user. When making a comparison of other producers' offerings, be certain these features are not overlooked. Latest version of the spec sheet available: [https://www.elkayfiles.com/spec-sheets/DLRS332210PD\\_spec.pdf](https://www.elkayfiles.com/spec-sheets/DLRS332210PD_spec.pdf)

<a href="#">LKDS99</a>	<p>3-1/2" Garbage Disposal Stopper / Strainer for use with Perfect Drain®-Chrome Polished Stainless Steel</p> <p><a href="#">Spec Sheet (PDF)</a></p>	
<a href="#">LKPDVR18B</a>	<p>Perfect Drain® Chrome Plated Brass Body Vandal-resistant Strainer</p> <p><a href="#">Spec Sheet (PDF)</a></p>	
<a href="#">LKGT1041</a>	<p>Elkay Gourmet Single Hole Kitchen Faucet Pull-out Spray and Lever Handle with Hi and Mid-rise Base Options</p> <p><a href="#">Spec Sheet (PDF)</a></p>	
<a href="#">LKWERBSS</a>	<p>Stainless Steel 15-3/8" x 12-3/8" x 5-7/16" Rinsing Basket</p> <p><a href="#">Spec Sheet (PDF)</a></p>	
<a href="#">LKSMHSL</a>	<p><a href="#">Spec Sheet (PDF)</a></p>	<p>NO IMAGE AVAILABLE</p>

*In keeping with our policy of continuing product improvement, Elkay reserves the right to change product specifications without notice. Please visit [elkay.com](http://elkay.com) for the most current version of Elkay product specification sheets. This specification describes an Elkay product with design, quality, and functional benefits to the user. When making a comparison of other producers' offerings, be certain these features are not overlooked. Latest version of the spec sheet available: [https://www.elkayfiles.com/spec-sheets/DLRS332210PD\\_spec.pdf](https://www.elkayfiles.com/spec-sheets/DLRS332210PD_spec.pdf)*