

PRODUCT SPECIFICATIONS

Dayton® Stainless Steel 31-3/4" x 20-1/2" x 10" 60/40 Double Bowl Undermount Sink and Faucet Kit with Bottom Grid. Sink is manufactured from 18 gauge 300 series Stainless Steel with a Radiant Satin finish, Center drain placement, and Bottom only pads.

Installation Type:	Sink Kits, Undermount
Material:	300 series Stainless Steel
Finish:	Radiant Satin
Gauge:	18
Sound Deadening:	Bottom only pads
Number of Bowls:	2
Sink Dimensions:	31-3/4" x 20-1/2" x 10"
Bowl 1 Dimensions:	13-1/2" x 18" x 10"
Bowl 2 Dimensions:	14" x 15-3/4" x 8"
Drain Size:	3-1/2" (89mm)
Drain Location:	Center
Minimum Cabinet Size:	36"
Mounting Hardware:	Undermount brackets sold separately
Template Included:	No
Cutout Template #:	1000001477

Template is available for download at elkay.com. CAD software will be required to open the template.



Included with Product: LK5000CR faucet, one GBG1318SS bottom grid, two drains

A Century of Tradition and Quality. For more than 100 years, Elkay has been making innovative products and providing exceptional customer care. We take pride in offering plumbing products that make life easier, inspire change and leave the world a better place.

Product Compliance: ASME A112.19.3/CSA B45.4
 Faucet: ASME A112.18.1/CSA B125.1
 CEC
 NSF 372 (lead free)
 NSF 61 (Q≤1)
Accessory: ASME A112.18.2/CSA B125.2

Installation Profile:

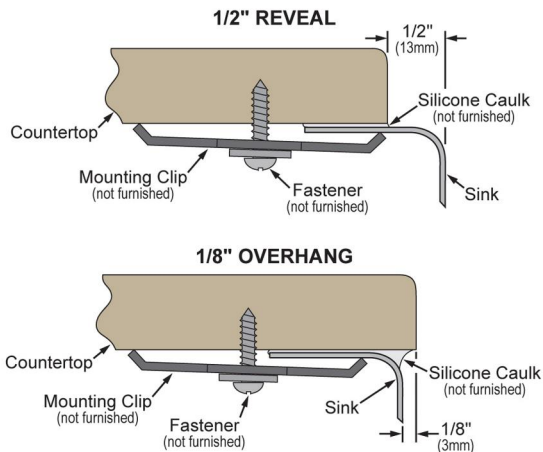



Designed to affix to the underside of any solid surface countertop.

Sinks are listed by IAPMO® as meeting the applicable requirements of the Uniform Plumbing Code®, International Plumbing Code®, and National Plumbing Code of Canada.



- [Clean and Care Manual \(PDF\)](#)
- [Installation Instructions \(PDF\) - 1000005239](#)
- [Installation Instructions \(PDF\) - LK5000 - Install Sheet](#)
- [Installation Instructions \(PDF\) - 1000005235](#)
- [Warranty \(PDF\)](#)

PART: _____ QTY: _____
 PROJECT: _____
 CONTACT: _____
 DATE: _____
 NOTES: _____
 APPROVAL: _____

In keeping with our policy of continuing product improvement, Elkay reserves the right to change product specifications without notice. Please visit elkay.com for the most current version of Elkay product specification sheets. This specification describes an Elkay product with design, quality, and functional benefits to the user. When making a comparison of other producers' offerings, be certain these features are not overlooked.

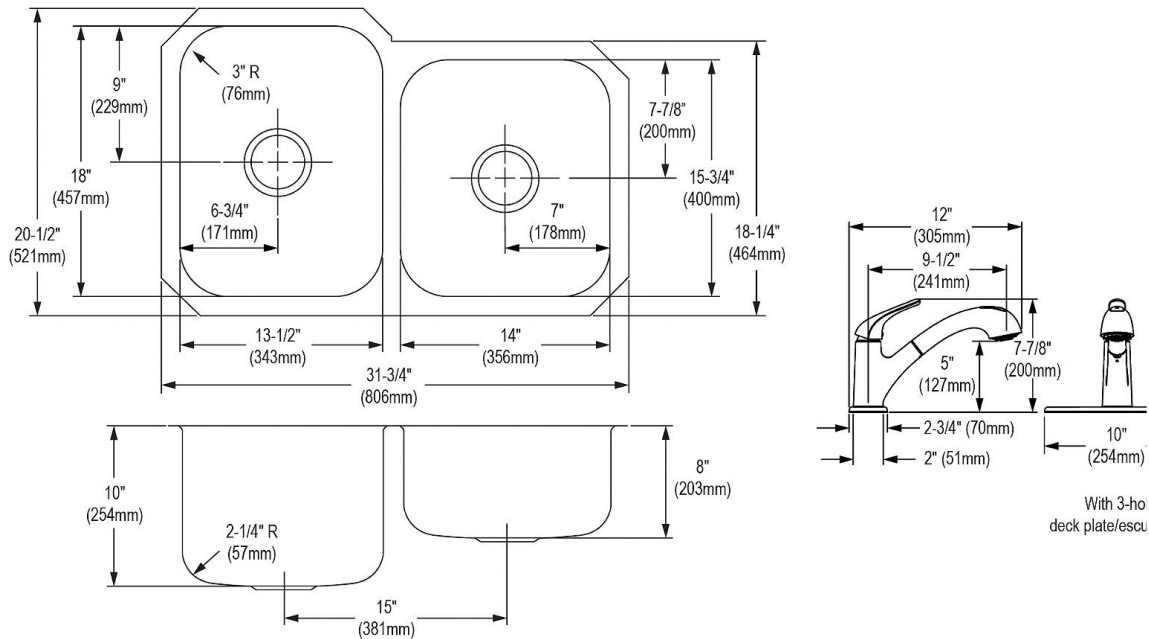
Included Accessories		
D1125	Dayton® 3-1/2" Stainless Steel Drain with Removable Basket Strainer and Rubber Stopper Spec Sheet (PDF)	
GBG1318SS	Dayton® Stainless Steel 10-5/8" x 15-3/16" x 1" Bottom Grid Spec Sheet (PDF)	
LK5000CR	Everyday Single Hole Deck Mount Kitchen Faucet with Pull-out Spray Lever Handle + Optional Escutcheon Chrome Spec Sheet (PDF)	



Optional Accessories		
GBG1415SS	Dayton® Stainless Steel 12-7/16" x 10-11/16" x 1" Bottom Grid Spec Sheet (PDF)	
LKW RB1316SS	Stainless Steel 12-1/2" x 15" x 7" Rinsing Basket Spec Sheet (PDF)	

In keeping with our policy of continuing product improvement, Elkay reserves the right to change product specifications without notice. Please visit elkay.com for the most current version of Elkay product specification sheets. This specification describes an Elkay product with design, quality, and functional benefits to the user. When making a comparison of other producers' offerings, be certain these features are not overlooked.