

### PRODUCT SPECIFICATIONS

Crosstown<sup>®</sup> 18 Gauge Stainless Steel 31-1/2" x 18-1/2" x 9" Equal Double Bowl Undermount Sink & Faucet Kit with Bottom Grid & Drain. Sink is handmade/fabricated from 18 gauge 304 Stainless Steel with a Polished Satin finish, Rear Center drain placement, and Full spray sides and bottom with Sides and Bottom pads.

<b>Installation Type:</b>	Undermount
<b>Material:</b>	304 Stainless Steel
<b>Finish:</b>	Polished Satin
<b>Gauge:</b>	18
<b>Sound Deadening:</b>	Full spray sides and bottom with Sides and Bottom pads
<b>Number of Bowls:</b>	2
<b>Sink Dimensions:</b>	31-1/2" x 18-1/2" x 9"
<b>Bowl 1 Dimensions:</b>	14-1/2" x 17" x 9"
<b>Bowl 2 Dimensions:</b>	14-1/2" x 17" x 9"
<b>Drain Size:</b>	3-1/2" (89mm)
<b>Drain Location:</b>	Rear Center
<b>Minimum Cabinet Size:</b>	36"
<b>Mounting Hardware:</b>	Included
<b>Template Included:</b>	Yes
<b>Cutout Template #:</b>	<a href="#">1000001381</a>

Template is available for download at [elkay.com](http://elkay.com). CAD software will be required to open the template.

#### Installation Profile:

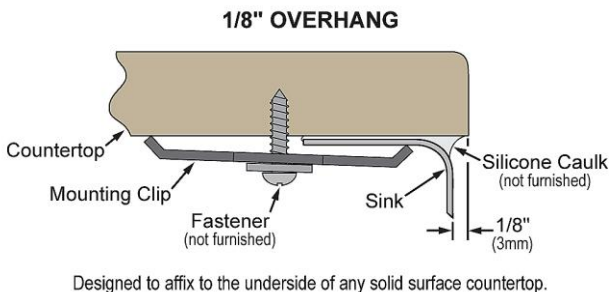

#### Included with Product:

2x Custom fit bottom grid CTXBG1316,  
2x deep strainer drain LKDD  
and faucet LKAV2061MBCR

A Century of Tradition and Quality. For more than 100 years, Elkay has been making innovative products and providing exceptional customer care. We take pride in offering plumbing products that make life easier, inspire change and leave the world a better place.



#### Product Compliance:

Faucet: ASME A112.19.3/CSA B45.4  
ASME A112.18.1/CSA B125.1  
NSF 61  
NSF 372 (lead free)

Accessory: ASME A112.18.2/CSA B125.2



Sinks are listed by IAPMO<sup>®</sup> as meeting the applicable requirements of the Uniform Plumbing Code<sup>®</sup>, International Plumbing Code<sup>®</sup>, and National Plumbing Code of Canada.

- [Clean and Care Manual \(PDF\)](#)
- [Clean and Care Manual \(PDF\)](#)
- [Installation Instructions \(PDF\) - 1000005239](#)
- [Installation Instructions \(PDF\) - 1000005235](#)
- [Warranty \(PDF\)](#)

PART: \_\_\_\_\_ QTY: \_\_\_\_\_

PROJECT: \_\_\_\_\_



CONTACT: \_\_\_\_\_

DATE: \_\_\_\_\_



NOTES: \_\_\_\_\_

APPROVAL: \_\_\_\_\_

In keeping with our policy of continuing product improvement, Elkay reserves the right to change product specifications without notice. Please visit [elkay.com](http://elkay.com) for the most current version of Elkay product specification sheets. This specification describes an Elkay product with design, quality, and functional benefits to the user. When making a comparison of other producers' offerings, be certain these features are not overlooked.

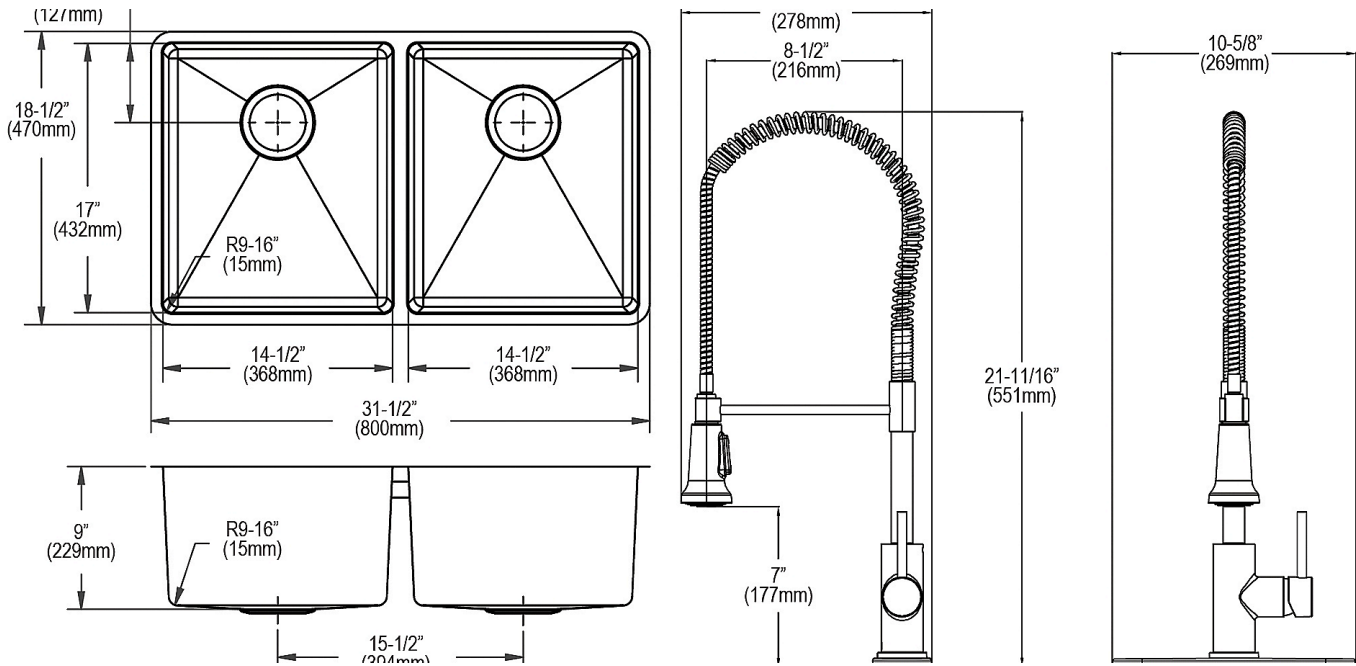
Included Accessories		
<a href="#">CTXBG1316</a>	Crosstown® Stainless Steel 13" x 15-1/2" x 1-1/4" Bottom Grid <a href="#">Spec Sheet (PDF)</a>	
<a href="#">LKAV2061MBCR</a>	Avado® Single Hole Kitchen Faucet with Semi-professional Spout and Lever Handle Matte Black and Chrome <a href="#">Spec Sheet (PDF)</a>	
<a href="#">LKDD</a>	3-1/2" Drain Fitting Deep Strainer Basket <a href="#">Spec Sheet (PDF)</a>	



Optional Accessories		
<a href="#">CTXBG1316</a>	Crosstown® Stainless Steel 13" x 15-1/2" x 1-1/4" Bottom Grid <a href="#">Spec Sheet (PDF)</a>	
<a href="#">LKDD</a>	3-1/2" Drain Fitting Deep Strainer Basket <a href="#">Spec Sheet (PDF)</a>	
<a href="#">LKAV2061</a>	Avado® Single Hole Kitchen Faucet with Semi-professional Spout and Lever Handle <a href="#">Spec Sheet (PDF)</a>	

In keeping with our policy of continuing product improvement, Elkay reserves the right to change product specifications without notice. Please visit [elkay.com](http://elkay.com) for the most current version of Elkay product specification sheets. This specification describes an Elkay product with design, quality, and functional benefits to the user. When making a comparison of other producers' offerings, be certain these features are not overlooked.

<a href="#">CTXBG1316</a>	Crosstown® Stainless Steel 13" x 15-1/2" x 1-1/4" Bottom Grid <a href="#">Spec Sheet (PDF)</a>	
---------------------------	---	---

*In keeping with our policy of continuing product improvement, Elkay reserves the right to change product specifications without notice. Please visit [elkay.com](http://elkay.com) for the most current version of Elkay product specification sheets. This specification describes an Elkay product with design, quality, and functional benefits to the user. When making a comparison of other producers' offerings, be certain these features are not overlooked.*