

**PRODUCT SPECIFICATIONS**

Quartz Classic® 25" x 22" x 9-1/2" Single Bowl Drop-in Sink Kit with Filtered Faucet. Sink is molded with up to 80% natural quartz and high performance acrylic resins that are non-porous providing superior heat, scratch, fade and stain resistance. Naturally sound deadening and Rear Center drain placement.

<b>Installation Type:</b>	Sink Kits, Drop-in
<b>Material:</b>	Quartz
<b>Finish:</b>	Black (BK), Greystone (GS), Mocha (MC), White (WH)
<b>Number of Bowls:</b>	1
<b>Sink Dimensions:</b>	25" x 22" x 9-1/2"
<b>Bowl 1 Dimensions:</b>	22-5/16" x 16-7/16" x 9-1/2"
<b>Drain Size:</b>	3-1/2" (89mm)
<b>Drain Location:</b>	Rear Center
<b>Minimum Cabinet Size:</b>	30"
<b>Mounting Hardware:</b>	Included
<b>Template Included:</b>	Yes
<b>Cutout Template #:</b>	<a href="#">0000001438</a>

Template is available for download at [elkay.com](#). CAD software will be required to open the template.

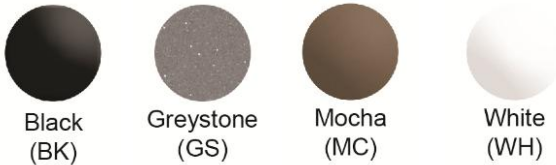

**Installation Profile:**

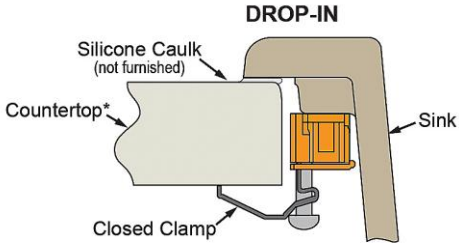

\*Maximum thickness for use of hold down system is 1-3/4" (44mm).



**Included with Product:**

LKAV7051FCR Faucet with filter included,  
LKQS35 Strainer,  
LKOBG2217SS Bottom Grid

A Century of Tradition and Quality. For more than 100 years, Elkay has been making innovative products and providing exceptional customer care. We take pride in offering plumbing products that make life easier, inspire change and leave the world a better place.



**Product Compliance:**

Faucet:

CSA B45.5/IAPMO Z124  
ASME A112.18.1/CSA B125.1  
NSF 61  
NSF 372 (lead free)

Accessory:

ASME A112.18.2/CSA B125.2  
NSF 42  
NSF 53  
NSF 401

[Clean and Care Manual \(PDF\)](#)  
[Installation Instructions \(PDF\) - 100005238](#)  
[Warranty \(PDF\)](#)

PART: \_\_\_\_\_ QTY: \_\_\_\_\_

PROJECT: \_\_\_\_\_

CONTACT: \_\_\_\_\_

DATE: \_\_\_\_\_





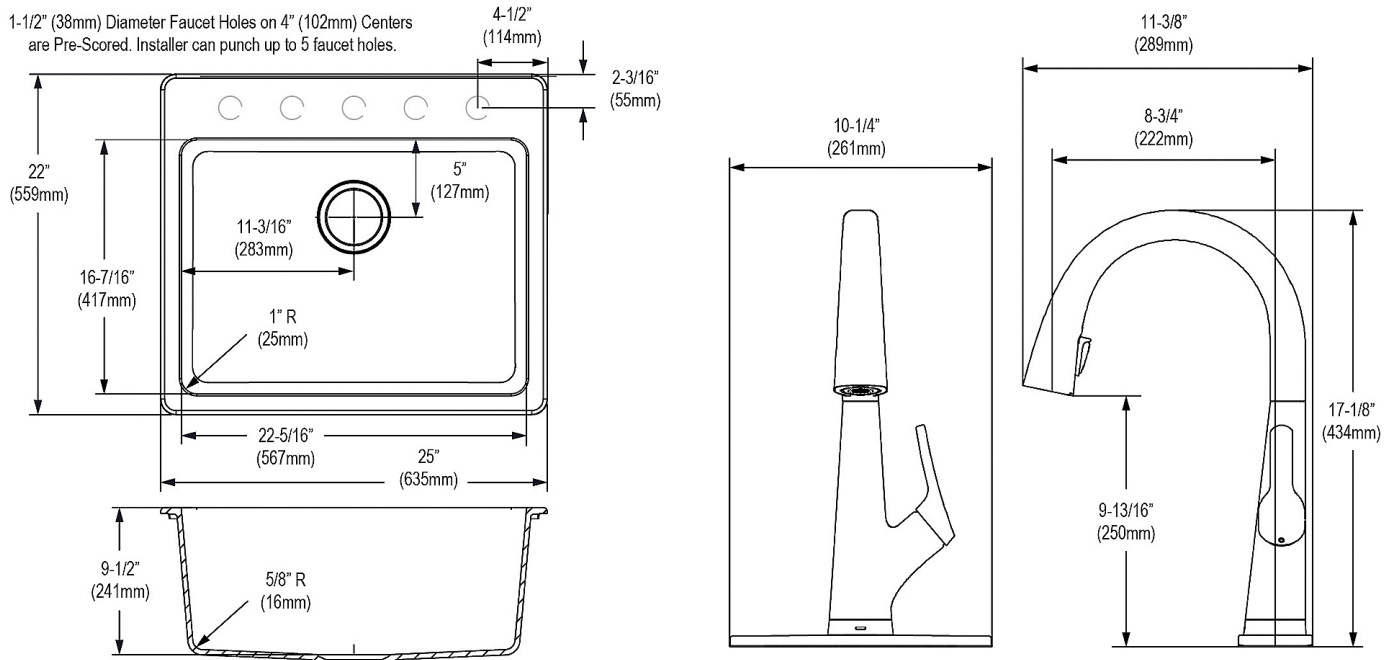

NOTES: \_\_\_\_\_

APPROVAL: \_\_\_\_\_



In keeping with our policy of continuing product improvement, Elkay reserves the right to change product specifications without notice. Please visit [elkay.com](#) for the most current version of Elkay product specification sheets. This specification describes an Elkay product with design, quality, and functional benefits to the user. When making a comparison of other producers' offerings, be certain these features are not overlooked.



Optional Accessories

<p><a href="#">LKCBEG2217HW</a></p>	<p>Hardwood 23-1/4" x 17-3/8" x 1" Cutting Board <a href="#">Spec Sheet (PDF)</a></p>	
<p><a href="#">LK99</a></p>	<p>Deluxe 3-1/2" Drain Type 304 Stainless Steel Body Strainer Basket Rubber Seal and Tailpiece <a href="#">Spec Sheet (PDF)</a></p>	
<p><a href="#">LKQD35</a></p>	<p>Polymer 3-1/2" Disposer Flange with Removable Basket Strainer and Rubber Stopper <a href="#">Spec Sheet (PDF)</a></p>	
<p><a href="#">LKQS35</a></p>	<p>Polymer 3-1/2" Drain Fitting with Removable Basket Strainer and Rubber Stopper <a href="#">Spec Sheet (PDF)</a></p>	
<p><a href="#">LKWERBSS</a></p>	<p>Stainless Steel 15-3/8" x 12-3/8" x 5-7/16" Rinsing Basket <a href="#">Spec Sheet (PDF)</a></p>	
<p><a href="#">ERF750</a></p>	<p>WaterSentry® Lead + Microplastics NSF/ANSI Certified Residential 750 Gal 12 Month Filter <a href="#">Spec Sheet (PDF)</a></p>	

In keeping with our policy of continuing product improvement, Elkay reserves the right to change product specifications without notice. Please visit [elkay.com](http://elkay.com) for the most current version of Elkay product specification sheets. This specification describes an Elkay product with design, quality, and functional benefits to the user. When making a comparison of other producers' offerings, be certain these features are not overlooked.

<a href="#">LKQD35</a>	Polymer 3-1/2" Disposer Flange with Removable Basket Strainer and Rubber Stopper <a href="#">Spec Sheet (PDF)</a>	
<a href="#">LKQS35</a>	Polymer 3-1/2" Drain Fitting with Removable Basket Strainer and Rubber Stopper <a href="#">Spec Sheet (PDF)</a>	

*In keeping with our policy of continuing product improvement, Elkay reserves the right to change product specifications without notice. Please visit [elkay.com](http://elkay.com) for the most current version of Elkay product specification sheets. This specification describes an Elkay product with design, quality, and functional benefits to the user. When making a comparison of other producers' offerings, be certain these features are not overlooked.*