

PRODUCT SPECIFICATIONS

Outdoor ezH2O® Upper Bottle Filling Station Bi-Level Pedestal with Pet Station Non-Filtered Non-Refrigerated. Features shall include Heavy Duty Vandal Resistant, Laminar Flow, Pet Fountain, 300 Series Stainless. Furnished with Vandal Resistant bubbler. Mechanical Button activation. Product shall be Floor Mount/Freestanding, for Outdoor applications, serving 2 station(s).

Special Features:	Heavy Duty Vandal Resistant, Laminar Flow, Pet Fountain, 300 Series Stainless
Finish:	Black (BK), Blue (BLU), Evergreen (EVG), Gray (GRY)
Power:	No Electrical Required
Bubbler Style:	Vandal Resistant
Activation by:	Mechanical Button
Mounting Type:	Floor Mount/Freestanding
Chilling Capacity:	Non-refrigerated
Dimensions (L x W x H):	26" x 31" x 64"
Approx. Shipping Weight:	205 lbs.
Installation Location**:	Outdoor
No. of Stations Served:	2

**When used in non-temperature controlled environments, unit(s) must be adequately winterized and/or protected from extreme heat to prevent damage where climates dictate.

Special Note: To meet the full requirements for ADA please choose LK4430BF1L for adult installations and LK4430BF1M for child ADA. Bottle Filler Stations 1 (Upper), Bubbler Stations 1 (Low), Choose from 4 color options

- Mechanically-Activated unit continues to supply water in event of service disruptions.
- Laminar flow provides clean fill with minimal splash.
- Pet Fountain: Features slow drainage for easy drinking.



Included with Product: Outdoor Bottle Filler Ships in one box.

A Century of Tradition and Quality. For more than 100 years, Elkay has been making innovative products and providing exceptional customer care. We take pride in offering plumbing products that make life easier, inspire change and leave the world a better place.



PRODUCT COMPLIANCE

- ADA & ICC A117.1
- ASME A112.19.3/CSA B45.4
- GreenSpec®
- NSF/ANSI 61 (Q≤1) & 372 (lead free)



Complies with ADA & ICC A117.1 accessibility requirements when installed according to the requirements outlined in these standards. Installation may require additional components and/or construction features to be fully compliant. Consult the local Authority Having Jurisdiction if necessary.

[Installation Instructions \(PDF\) - 1000003948](#)

Warranty pertains to drinking water applications only. Non-drinking water applications are not covered under warranty.

[Warranty \(PDF\)](#)

PART: _____ QTY: _____

PROJECT: _____

CONTACT: _____

DATE: _____

NOTES: _____

APPROVAL: _____

In keeping with our policy of continuing product improvement, Elkay reserves the right to change product specifications without notice. Please visit elkay.com for the most current version of Elkay product specification sheets. This specification describes an Elkay product with design, quality, and functional benefits to the user. When making a comparison of other producers' offerings, be certain these features are not overlooked.

Optional Accessories		
97890C	Accessory - Direct Bury Adaptor Spec Sheet (PDF)	
4481FP	Outdoor Bottle Filler Foot Pedal Accessory Spec Sheet (PDF)	

In keeping with our policy of continuing product improvement, Elkay reserves the right to change product specifications without notice. Please visit elkay.com for the most current version of Elkay product specification sheets. This specification describes an Elkay product with design, quality, and functional benefits to the user. When making a comparison of other producers' offerings, be certain these features are not overlooked.

**MOUNTING INSTRUCTIONS and
PLUMBING CONNECTIONS**

Provide solid, well-drained surface to mount pedestal fountain (concrete pad recommended). Mount on a smooth, flat, finished surface with adequate support (300 lb. load minimum). Secure unit with (8) 3/8" minimum fasteners (not included). Refer to rough-in. Should be attached firmly to mounting surface in order to secure unit.

Modified low stream height bubbler for pet fountain.

Locate and install plumbing through ground as required.

NOTE: Unit is not furnished with service valve.

Position pedestal over plumbing and secure base to fasteners. Remove access panels and connect supply and water lines. Turn on water supply and check for leaks. Reassemble access panels to pedestal.

Trap and service stop not included.

OPERATING PRESSURES:
Supply water 20 – 105 psi maximum

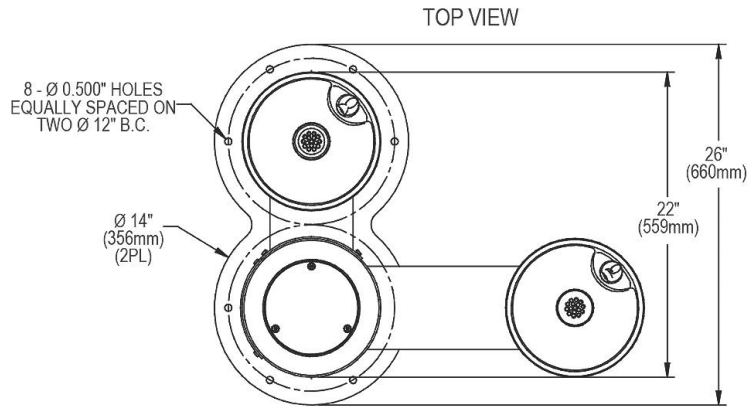

FRONT & SIDE VIEWS

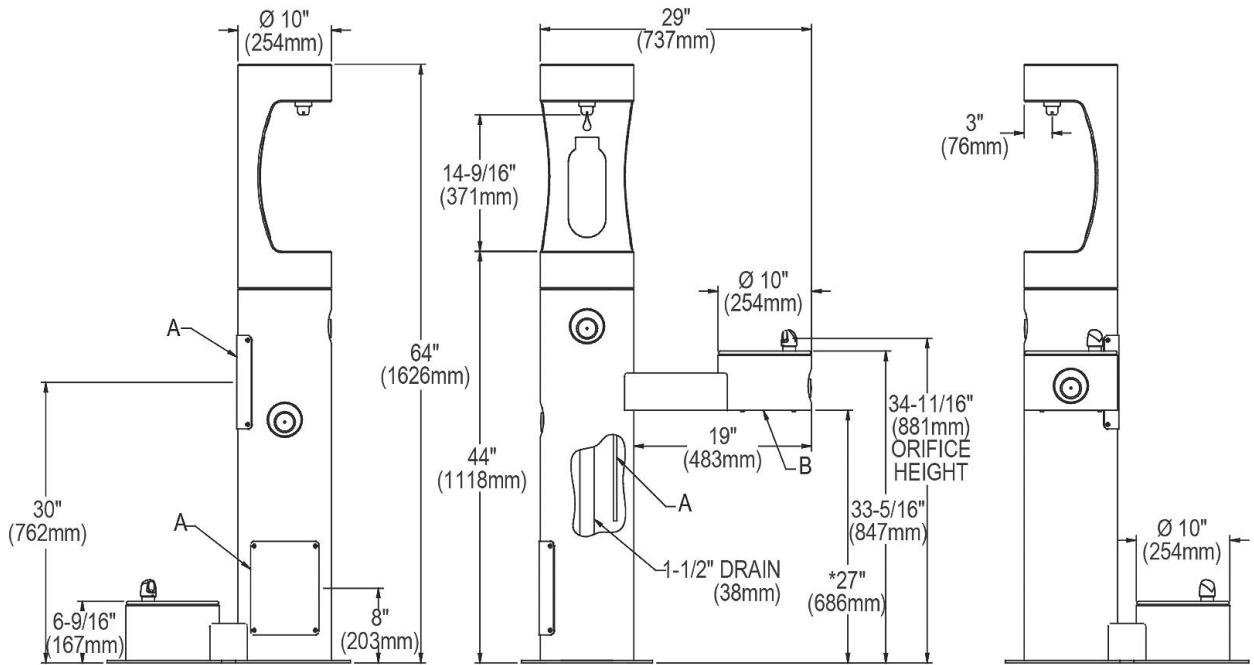

A = 3/8" O.D. Unplated copper tube connect. Shut off valve by others.
B = Access panel(8" x 10").
C = Removable bottom cover.
Note : New Installations Must Use Ground Fault Circuit Interrupter (GFCI).

* ADA Requirement

In keeping with our policy of continuing product improvement, Elkay reserves the right to change product specifications without notice. Please visit elkay.com for the most current version of Elkay product specification sheets. This specification describes an Elkay product with design, quality, and functional benefits to the user. When making a comparison of other producers' offerings, be certain these features are not overlooked.