

Stainless Steel 22-1/2" x 18-1/2" x 9" Undermount Single Bowl Radiant Satin 18 Gauge Sink 50 pk Model(s) MFD105-50

SPECIFICATIONS

PRODUCT SPECIFICATIONS

Stainless Steel 22-1/2" x 18-1/2" x 9" Undermount Single Bowl Radiant Satin 18 Gauge Sink 50 pk. Sink is manufactured from 18 gauge 304 Stainless Steel with a Radiant Satin finish, Rear Center drain placement, and Full spray sides and bottom with Sides and Bottom pads.

Installation Type:	Undermount
Material:	304 Stainless Steel
Finish:	Radiant Satin
Gauge:	18
Sound Deadening:	Full spray sides and bottom with Sides and Bottom pads
Number of Bowls:	1
Sink Dimensions:	22-1/2" x 18-1/2" x 9"
Bowl 1 Dimensions:	21" x 17" x 9"
Drain Size:	3-1/2" (89mm)
Drain Location:	Rear Center
Minimum Cabinet Size:	30"
Cutout Template #:	1000003457

Template is available for download at elkay.com. CAD software will be required to open the template.

NOTE: MUST BE ORDERED IN MULTIPLES OF 50

Installation Profile:

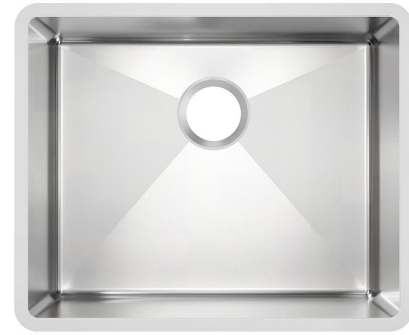
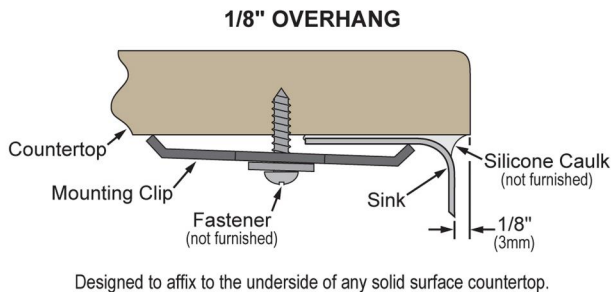

A Century of Tradition and Quality.

For more than 100 years, Elkay has been making innovative products and providing exceptional customer care. We take pride in offering plumbing products that make life easier, inspire change and leave the world a better place.

[Clean and Care Manual \(PDF\)](#)

[Installation Instructions \(PDF\) - 1000005239](#)

[Warranty \(PDF\)](#)

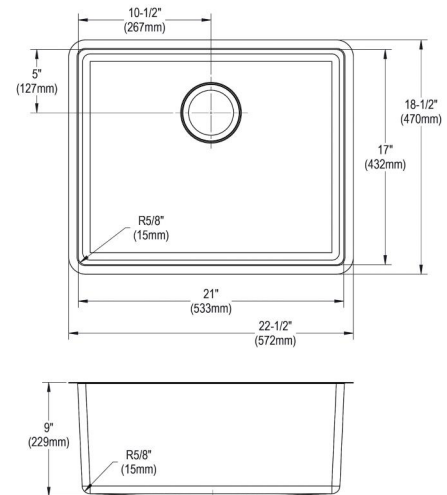

PART: _____ QTY: _____

PROJECT: _____

CONTACT: _____

DATE: _____

NOTES: _____

APPROVAL: _____

In keeping with our policy of continuing product improvement, Elkay reserves the right to change product specifications without notice. Please visit elkay.com for the most current version of Elkay product specification sheets. This specification describes an Elkay product with design, quality, and functional benefits to the user. When making a comparison of other producers' offerings, be certain these features are not overlooked.