

Stainless Steel Sink 23-1/2" x 18-1/4" x 5-1/2" Undermount Single Bowl 20 Gauge Model(s) MFV109

SPECIFICATIONS

PRODUCT SPECIFICATIONS

Stainless Steel Sink 23-1/2" x 18-1/4" x 5-1/2" Undermount Single Bowl 20 Gauge. Sink is manufactured from 20 gauge 300 series Stainless Steel with a Satin finish, Rear Center drain placement, and Bottom only pads.

Installation Type:	Undermount
Material:	300 series Stainless Steel
Finish:	Satin
Gauge:	20
Sound Deadening:	Bottom only pads
Number of Bowls:	1
Sink Dimensions:	23-1/2" x 18-1/4" x 5-1/2"
Bowl 1 Dimensions:	21" x 15-3/4" x 5-1/2"
Drain Size:	3-1/2" (89mm)
Drain Location:	Rear Center
Minimum Cabinet Size:	27"
Mounting Hardware:	Part # 64090008 included for countertops up to 3/4" (19mm) thick
Template Included:	No
Cutout Template #:	2000002317

Template is available for download at elkay.com. CAD software will be required to open the template.



A Century of Tradition and Quality. For more than 100 years, Elkay has been making innovative products and providing exceptional customer care. We take pride in offering plumbing products that make life easier, inspire change and leave the world a better place.



Product Compliance: ADA & ICC A117.1
ASME A112.19.3/CSA B45.4

Installation Profile:

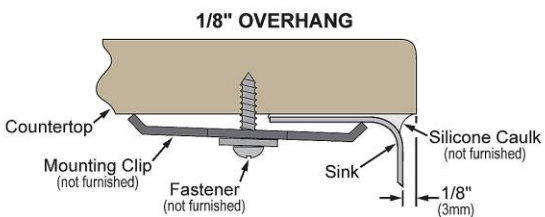
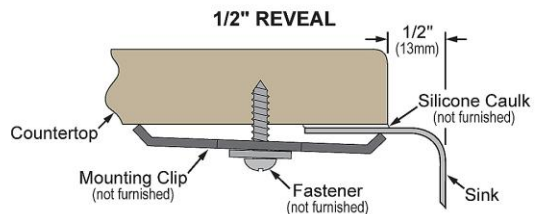

Designed to affix to the underside of any solid surface countertop.

Sinks are listed by IAPMO® as meeting the applicable requirements of the Uniform Plumbing Code®, International Plumbing Code®, and National Plumbing Code of Canada.



Complies with ADA & ICC A117.1 accessibility requirements when installed according to the requirements outlined in these standards.

[Clean and Care Manual \(PDF\)](#)
[Installation Instructions \(PDF\) - 100005239](#)
[Warranty \(PDF\)](#)

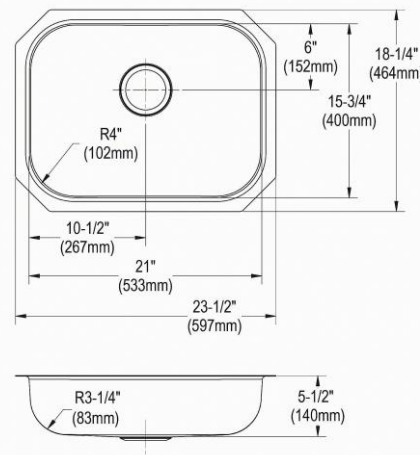

PART: _____ QTY: _____
 PROJECT: _____
 CONTACT: _____
 DATE: _____
 NOTES: _____
 APPROVAL: _____

In keeping with our policy of continuing product improvement, Elkay reserves the right to change product specifications without notice. Please visit elkay.com for the most current version of Elkay product specification sheets. This specification describes an Elkay product with design, quality, and functional benefits to the user. When making a comparison of other producers' offerings, be certain these features are not overlooked.