

PRODUCT SPECIFICATIONS

Sturdibilt® Stainless Steel 19" x 23" x 4" Wall Hung Single Bowl Lavatory Sink Kit. Sink is manufactured from 18 gauge 304 Stainless Steel with a Buffed Satin finish, Rear Center drain placement.

Material:	304 Stainless Steel
Finish:	Buffed Satin
Gauge:	18
Number of Bowls:	1
Sink Dimensions:	19" x 23" x 9"
Bowl 1 Dimensions:	16" x 13-1/2" x 4"
Drain Size:	1-1/2" (38mm)
Drain Location:	Rear Center



Included with Product: WCL1923 sink,
one LKB721C sensor faucet with AC
plug-in / 4 AA batteries,
one LK724 mechanical mixing valve,
LKAD174LO drain

▼ **Ships in multiple boxes.**

A Century of Tradition and Quality. For more than 100 years, Elkay has been making innovative products and providing exceptional customer care. We take pride in offering plumbing products that make life easier, inspire change and leave the world a better place.



Product Compliance: ADA & ICC A117.1
NSF 2
ASME A112.19.3/CSA B45.4
Faucet: NSF 372 (lead free)
NSF 61 (Q≤1)
ASME A112.18.1/CSA B125.1
Accessory: ASME A112.18.2/CSA B125.2



Sinks are listed by IAPMO® as meeting the applicable requirements of the Uniform Plumbing Code®, International Plumbing Code®, and National Plumbing Code of Canada.



Complies with ADA & ICC A117.1 accessibility requirements when installed according to the requirements outlined in these standards.

[Clean and Care Manual \(PDF\)](#)
[Installation Instructions \(PDF\) - 200000714](#)
[Warranty \(PDF\)](#)

PART: _____ QTY: _____
PROJECT: _____
CONTACT: _____
DATE: _____
NOTES: _____
APPROVAL: _____

In keeping with our policy of continuing product improvement, Elkay reserves the right to change product specifications without notice. Please visit elkay.com for the most current version of Elkay product specification sheets. This specification describes an Elkay product with design, quality, and functional benefits to the user. When making a comparison of other producers' offerings, be certain these features are not overlooked.

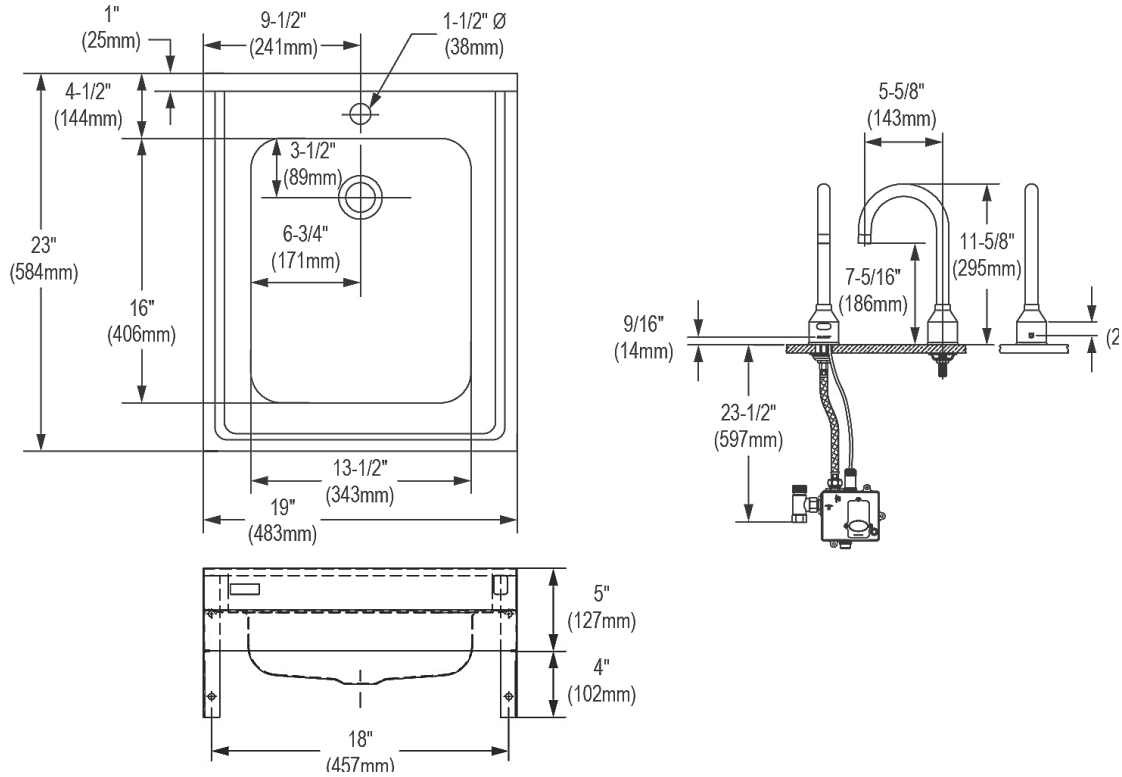

In keeping with our policy of continuing product improvement, Elkay reserves the right to change product specifications without notice. Please visit elkay.com for the most current version of Elkay product specification sheets. This specification describes an Elkay product with design, quality, and functional benefits to the user. When making a comparison of other producers' offerings, be certain these features are not overlooked.

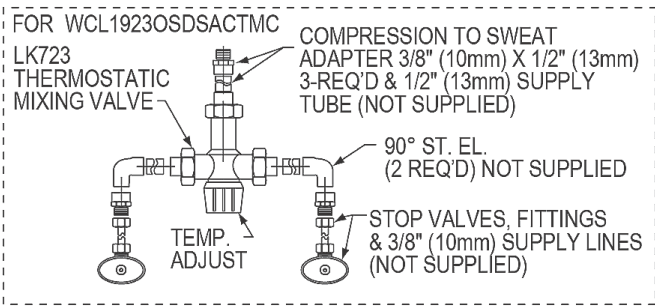
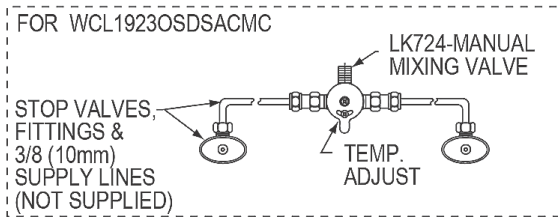
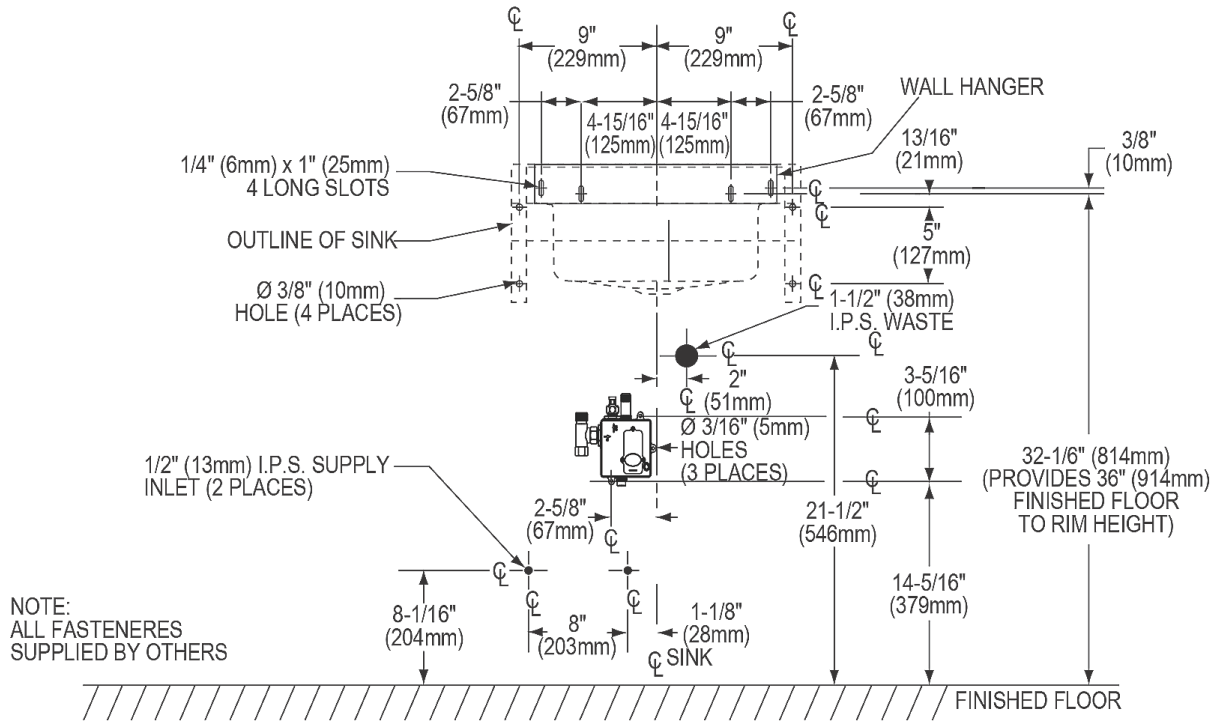

NOTE:
USE TEFLON TAPE FOR ALL WATER CONNECTIONS.
DO NOT USE PIPE DOPE.

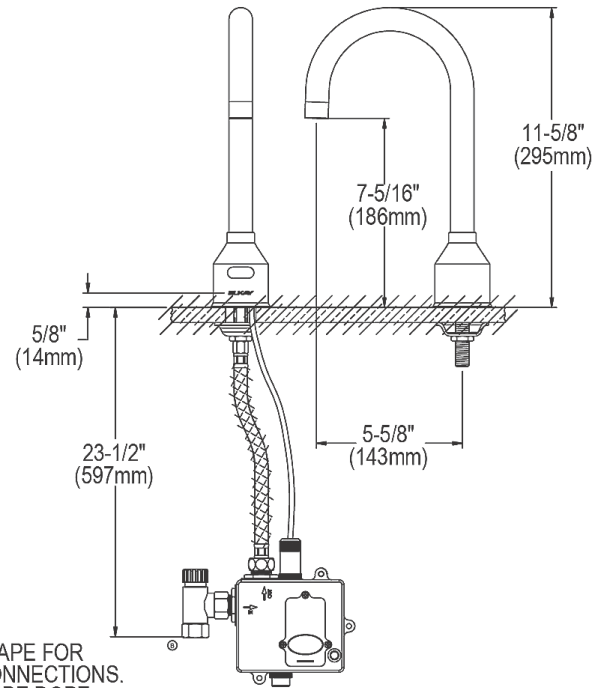

In keeping with our policy of continuing product improvement, Elkay reserves the right to change product specifications without notice. Please visit elkay.com for the most current version of Elkay product specification sheets. This specification describes an Elkay product with design, quality, and functional benefits to the user. When making a comparison of other producers' offerings, be certain these features are not overlooked.