

ALL-IN

THE FLEXIBLE FOOD PREPARATION SYSTEM

GREAT MEALS,
NO INTERRUPTIONS

IT ALL COMES
TOGETHER
WITH ALL-IN

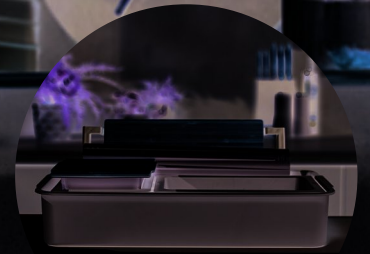
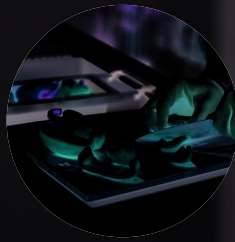

FRANKE

Discover All-In – designed to bring more flow to kitchens and life

Transforming sinks into a stylish and playful workstation, **All-In** is the flexible food preparation system designed to bring more flow to your consumers kitchen and life.

Well-equipped and intuitive, this modular system has all they need to prepare meals with ease, by putting the accessories they need within easy reach.

Designed to save both time and space, **All-In** lets consumers customize their work area to suit their needs perfectly – giving them full control and allowing them to shift seamlessly between different tasks.

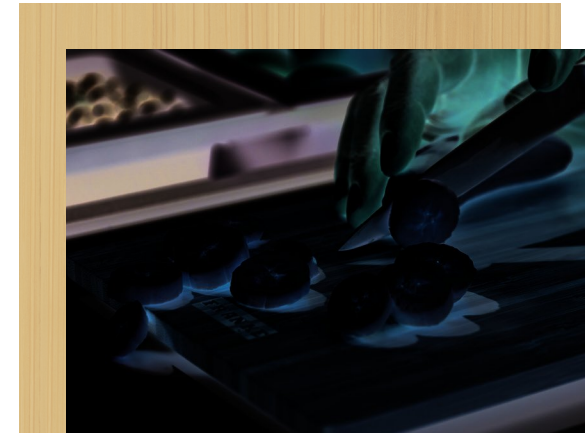

Prepare

Using the bamboo board, telescopic bridge, strainer and collector bowls, All-In can help:

- Chop vegetables and other ingredients
- Collect the cut food
- Collect peelings and dispose of waste
- Store prepped ingredients in the fridge

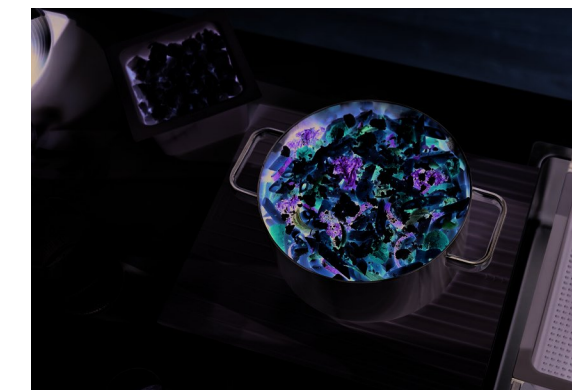

Cook

The bridge, strainer bowls and foldable pad are very useful at the cooking stage All-In can help:

- Rest pots and pans on the bridge while filling them from the tap
- Use the strainer to drain pasta, or other ingredients
- Stand hot pans and dishes on the foldable pad to protect work surfaces



Clean

When it's time to wash up, the bridge, strainer bowls and foldable pad can also help:

- Drain glasses and dishes
- Drain cutlery and cooking utensils

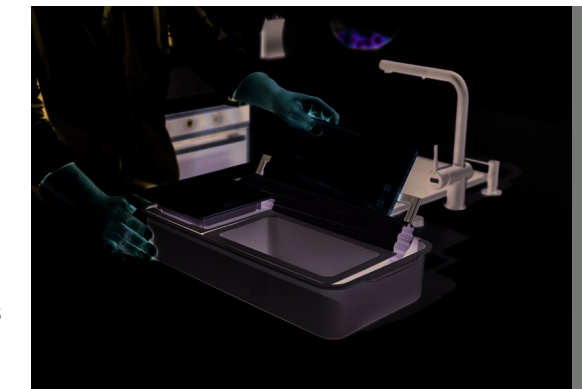

Tidy

Once the washing up is finished, All-In can help to tidy everything away, whether it's to:

- Store cleaning items in the sink
- Keep all accessories together in the storage box
- Put everything away neatly in your kitchen cabinets

Eight accessories, endless uses, fits any sink*

Breakfast with the kids or supper with friends; whatever meal is being prepared, **All-In** enables you to work in a more fluid way.

A smart, flexible system that's adaptable to any sink*, it features eight separate accessories with multiple uses.

*Up to 21 1/4"

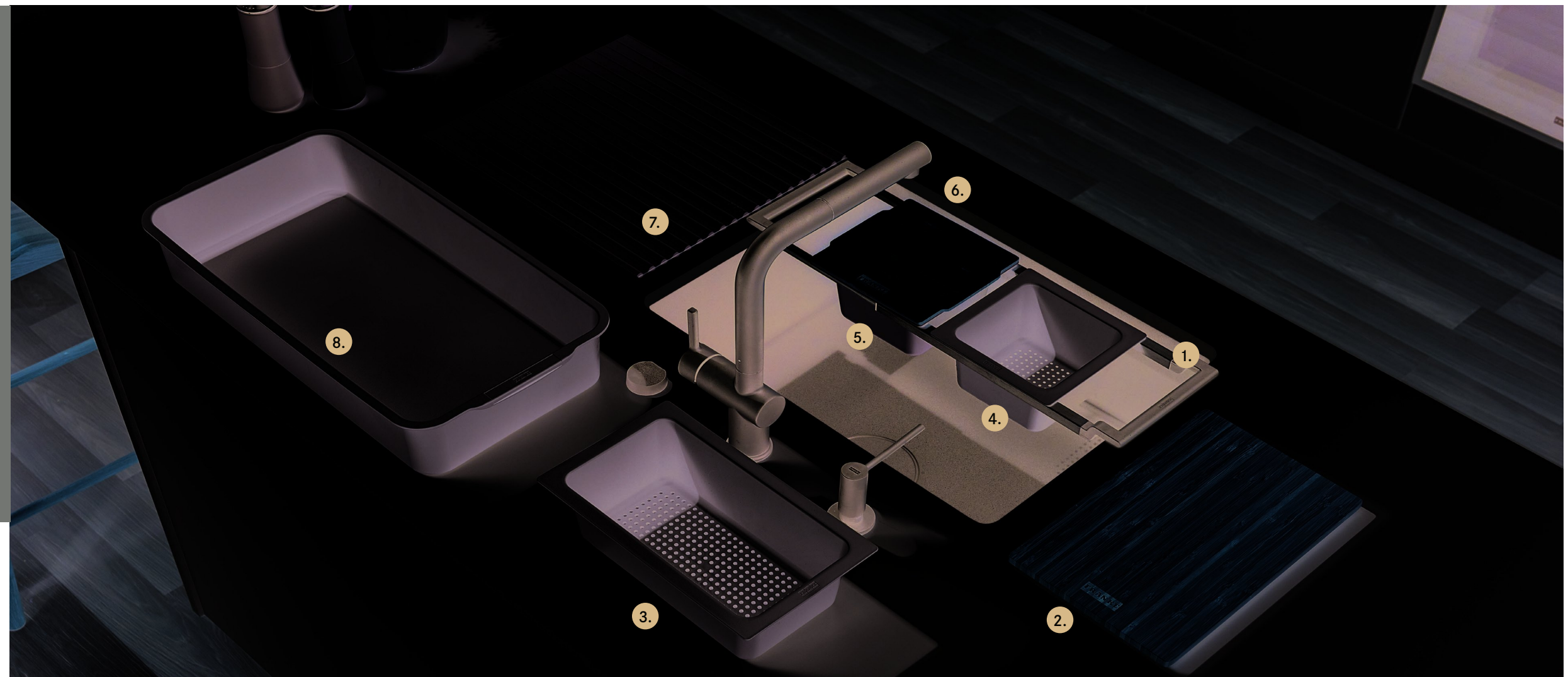

The system explained

Compatible with most sink*,

All-In includes:

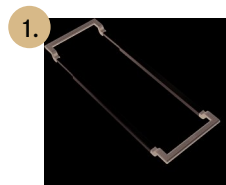

Telescopic Bridge

Featuring extendable stainless steel rails with durable handles that will adjust to fit bowls up to 21 1/4". Incorporates small feet that sit against the sink edge to ensure a stable fit.



Bamboo Chopping Board

With feet built into the underside, the bamboo board can be positioned above the sink rim, or sits securely onto the bridge's stainless steel rails.



Large Colander

The large colander allows you to rinsing fruits and vegetables, or drain pasta over the sink. Also, works perfectly as a drain basket for cutlery and cooking utensils.



Small Colander

Pair the small colander and prep bowl in the bridge for a multi-purpose prep station. The colander is perfect for rinsing, and the bowl is ideal for collecting stems or peels.



Prep Bowl

The small bowl can be used for collecting prepared ingredients and storing them in the fridge. Equally, it can be used for collecting peelings and dealing with waste during preparation.



Bamboo Bowl Lid

Placed securely on top of the small bowl, the bamboo lid can help to keep food fresh.



Foldable Silicone Mat

Foldable for easy storage and with an inclined surface for use as a dish drying mat that channels water back into the sink. Heat resistant and can withstand pots and pans straight from the oven.



Storage Container

The soft touch storage box easily accommodates the All-In accessories in one place so that everything is easily accessible for meal prep.



Configurations to suit every lifestyle

As you'd expect from Franke, **All-In** seamlessly blends exceptional functionality with outstanding design – making preparing meals a pleasure.

Reflecting contemporary kitchen trends, the system combines neutral color tones with tactile materials. A stunning addition to

any kitchen and one they will want to show off, **All-In** is the perfect match for all our Granite and Stainless Steel sink ranges*.

Inspired, intuitive and in tune with how you prepare, cook and clean up after meals, let **All-In** bring altogether more flow and harmony to the kitchen.

* Fits sinks up to 21 ¼"



reddot winner 2022

The Sets Explained

All-In is available in three configurations to suit your needs:

AIUS100

All-In - Set 1

- Telescopic Bridge
- Large Colander
- Bamboo Chopping Board



Telescopic Bridge



Large Colander



Bamboo Chopping Board

AIUS200

All-In - Set 2

- Telescopic Bridge
- Small Colander
- Prep Bowl
- Bamboo Bowl Lid
- Bamboo Chopping Board
- Foldable Silicone Mat

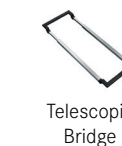

Telescopic Bridge

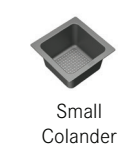

Small Colander



Prep Bowl

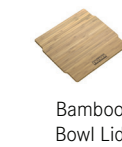

Bamboo Bowl Lid

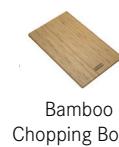

Bamboo Chopping Board

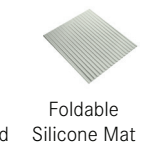

Foldable Silicone Mat

AIUS300

All-In - Set 3

- Telescopic Bridge
- Large Colander
- Small Colander
- Prep Bowl
- Bamboo Bowl Lid
- Bamboo Chopping Board
- Foldable Silicone Mat
- Storage Container

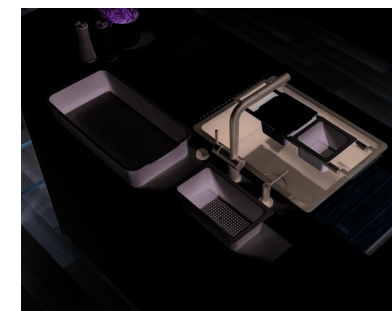

Telescopic Bridge



Large Colander

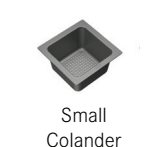

Small Colander



Prep Bowl

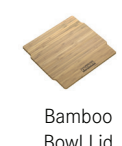

Bamboo Bowl Lid



Bamboo Chopping Board



Foldable Silicone Mat



Storage Bowl

To discover more exclusive All-In content, scan here.





Franke Home Solutions

USA
800 Aviation Parkway
Smyrna, TN 37167
800-626-5771
franke.us

CANADA
1000 Franke Kindred Road
Midland, Ontario Canada L4R 4K9
866-687-7465
www.franke.ca

