

BILL OF MATERIAL (CURRENT LEVEL)				
ITEM	PT/ASSY	DESCRIPTION	TYPE	QTY.
1	1-241	HARDWARE PACK	ASSEMBLY	1
2	40409	GLASS SHADE	PART	1
3	40410	LIGHT BASE	PART	1
4	40411	LIGHT COVER	PART	1
5	40436	BOTTOM COVER / SPRING CLIP	PART	1
6	91033	GROMMET - RUBBER	PART	1
7	91513	18W, 4-Pin (G24Q-2) BASE, COMPACT FLUORESCENT LAMP, 2700K WARM WHITE COLOR	PART	1
8	91531	GU-24 BASE LAMPHOLDER -QUICK CONNECT	PART	1
9	91532	GU-24 SOCKET SELF BALLASTED LAMPHOLDER -QUICK CONNECT	PART	1
10	92036	SCREW- FLT HD 8-32 X 3/8	PART	2
11	92047	SCRW 6-32 X 1/4 IN. RND HD SS	PART	2
12	92169	NUT 8-32 x 5/16 STL	PART	2
13	92461	SCRW,M6X1X6 CONE POINT SET SS (MMC# 91217A210)	PART	1
14	98006	LABEL, UL LISTED	PART	1
15	98069	LABEL, PNXXX, SUITABLE FOR DAMP LOCATIONS	PART	1
16	98070	LABEL, MONTH YEAR E191501	PART	1
17	98080	LABEL, WALL MOUNT ONLY	PART	1
18	98081	LABEL, 120V / 60H / 18W	PART	1
19	98088	LABEL, MIN 75 C SUPPLY CONDUCTORS	PART	1
20	98125	LABEL, ORIENTATION MARKING	PART	1
21	98139	LABEL, 18 WATT MAX CFL PERMITTED	PART	1

1 APPLY PERMANENT THREAD LOCKER (LOCTITE 680)

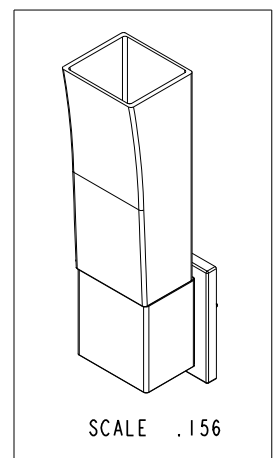
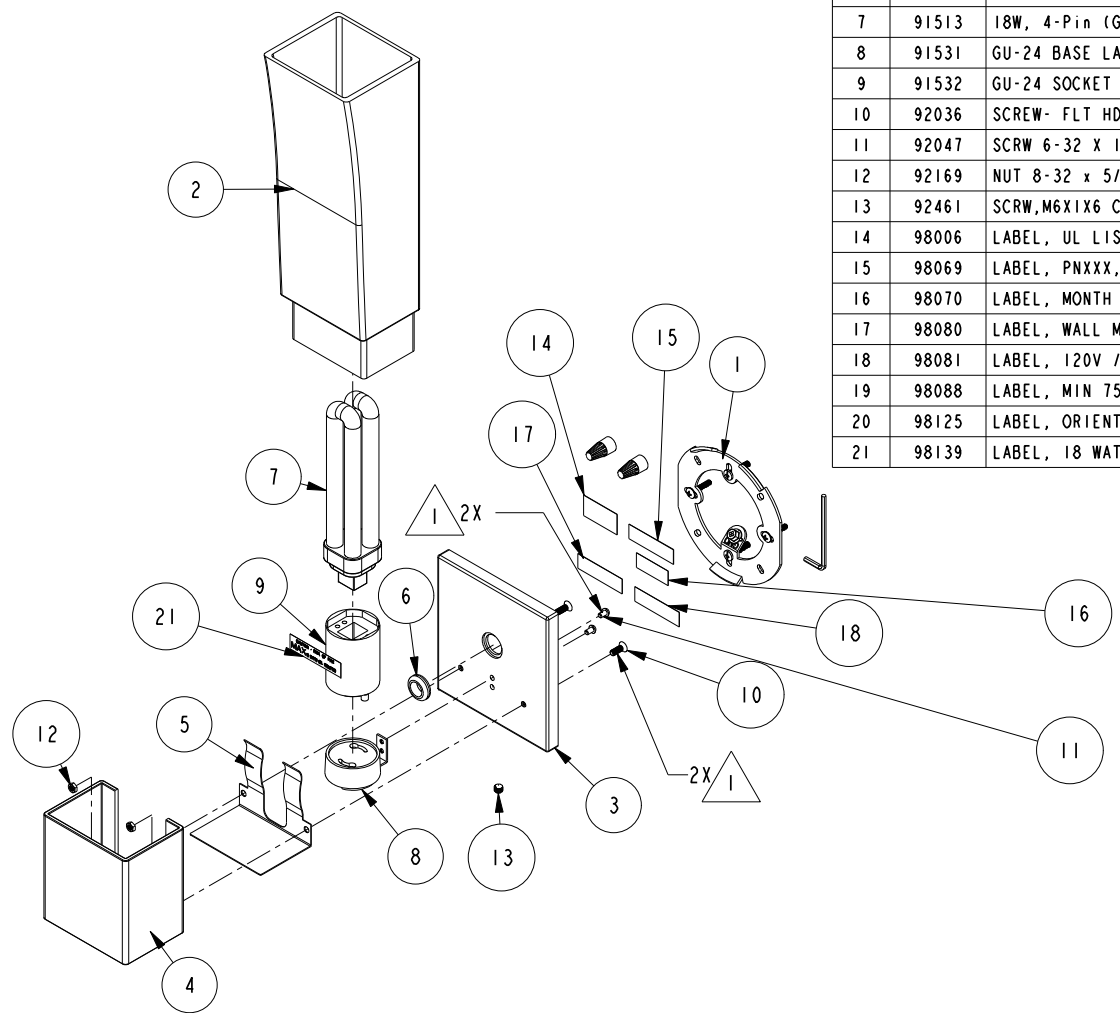

COPYRIGHT 2005 GINGER. THESE DRAWINGS AND THE DESIGNS DEPICTED HEREIN ARE THE PROPRIETARY PROPERTY OF GINGER. ANY USE OR REPRODUCTION IS SUBJECT TO THE EXPRESS APPROVAL OF GINGER. UNAUTHORIZED USE IS STRICTLY PROHIBITED. ALL RIGHTS RESERVED.

GINGER	2001 E. CARNEGIE AVE. SANTA ANNA CA 92705 (949) 417-5207	SINGLE LIGHT	ASSY. NO. 4781		
			SCALE .187	REF. - SHEET 1 OF 3	
			REV	REV DESC	DATE

C	EN-1927	10/12/11
B	EN-1770	05/24/11
A	EN-1712	03/16/11
-	EN-1294	11/09/10

SPECIFICATION DWG

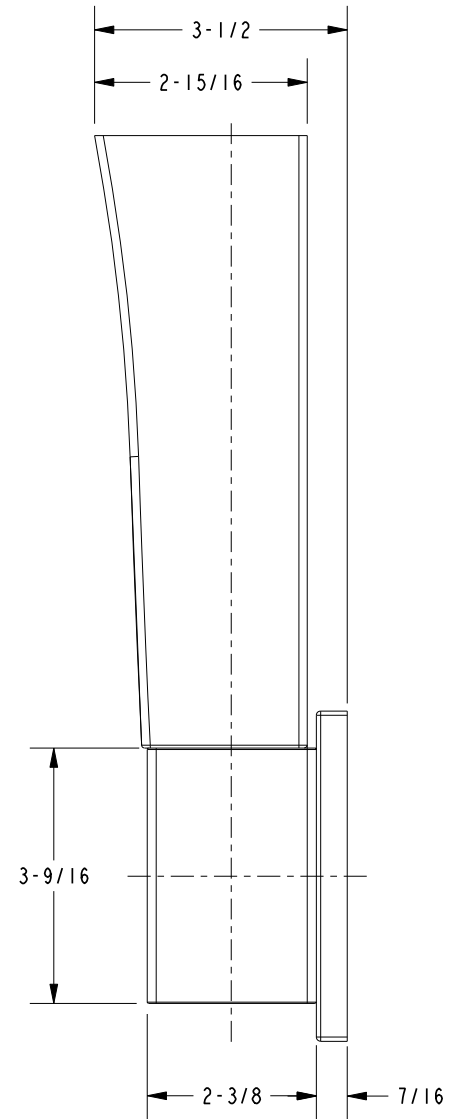
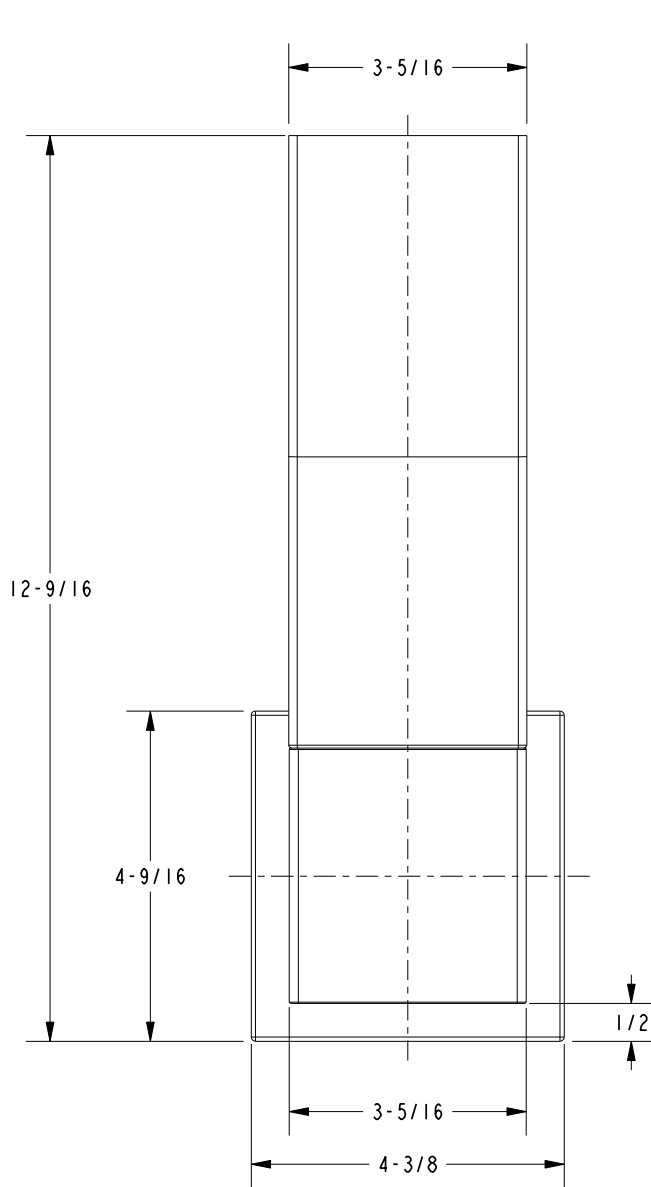

DIMENSIONS ARE IN INCHES AND AN APPROXIMATION OF A TYPICAL INSTALLATION

COPYRIGHT 2005 GINGER. THESE DRAWINGS AND THE DESIGNS DEPICTED HEREIN ARE THE PROPRIETARY PROPERTY OF GINGER. ANY USE OR REPRODUCTION IS SUBJECT TO THE EXPRESS APPROVAL OF GINGER. UNAUTHORIZED USE IS STRICTLY PROHIBITED. ALL RIGHTS RESERVED.

GINGER		2001 E. CARNEGIE AVE. SANTA ANNA CA 92705 (949) 417-5207	
		DWG NO. 4781	REV C
SCALE .375	REF. -	SHEET 2 OF 3	

SPECIFICATION DWG

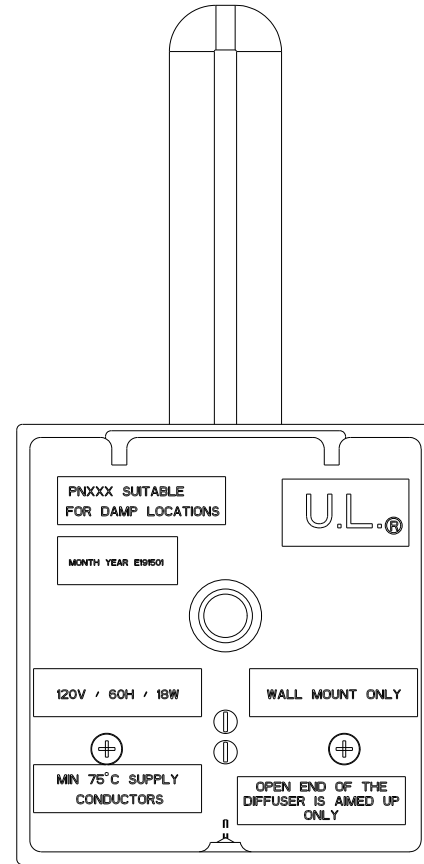
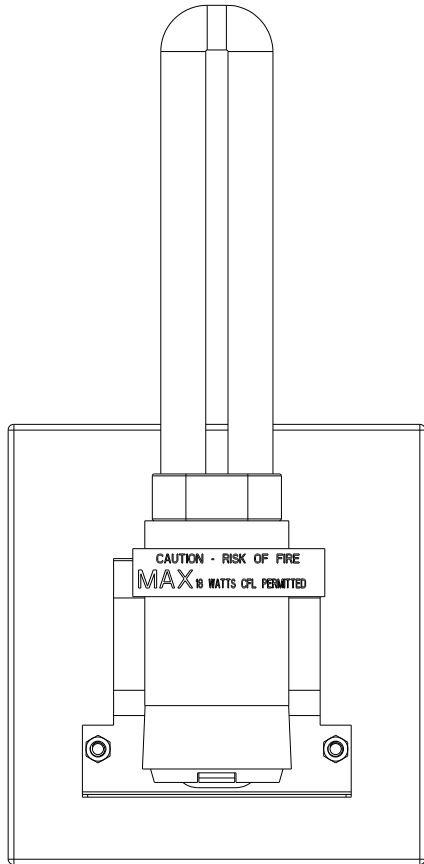
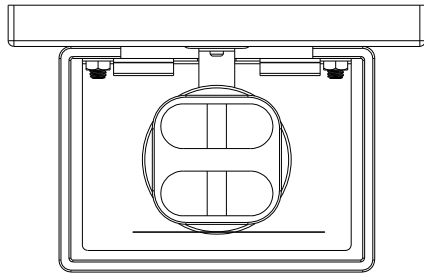

PXXXX SUITABLE FOR DAMP LOCATIONS

U.L.®

MONTH YEAR E19501

120V / 60H / 18W

WALL MOUNT ONLY

MIN 75°C SUPPLY CONDUCTORS

OPEN END OF THE DIFFUSER IS AIMED UP ONLY

DIMENSIONS ARE IN INCHES AND AN APPROXIMATION OF A TYPICAL INSTALLATION

COPYRIGHT 2005 GINGER. THESE DRAWINGS AND THE DESIGNS DEPICTED HEREIN ARE THE PROPRIETARY PROPERTY OF GINGER. ANY USE OR REPRODUCTION IS SUBJECT TO THE EXPRESS APPROVAL OF GINGER. UNAUTHORIZED USE IS STRICTLY PROHIBITED. ALL RIGHTS RESERVED.

GINGER		2001 E. CARNEGIE AVE. SANTA ANA CA 92705 (949) 417-5207	
DWG NO.	4781	REV	C
SCALE	.500	REF.	-
		SHEET	3 OF 3