

Talis S
Single-Hole Faucet 80, 1.0 GPM
 Finishes : **chrome** Part no. : **72018001**



Description

Features

- Aerated spray
- Flow: 1.0 GPM (3.8 L/Min)
- Ceramic cartridge

Item details

List Price \$ 207.00

Technology



Compliance



Product image

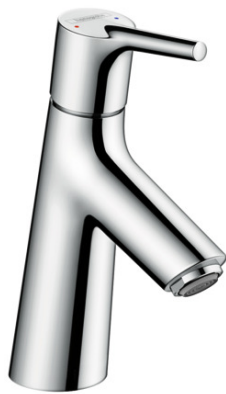

Scale drawing

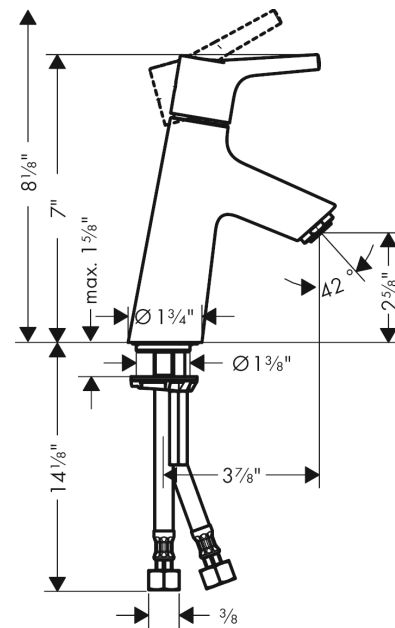

Talis S
Single-Hole Faucet 80, 1.0 GPM
 Finishes : **chrome** Part no. : **72018001**



Exploded drawing

Year of production: >08/16

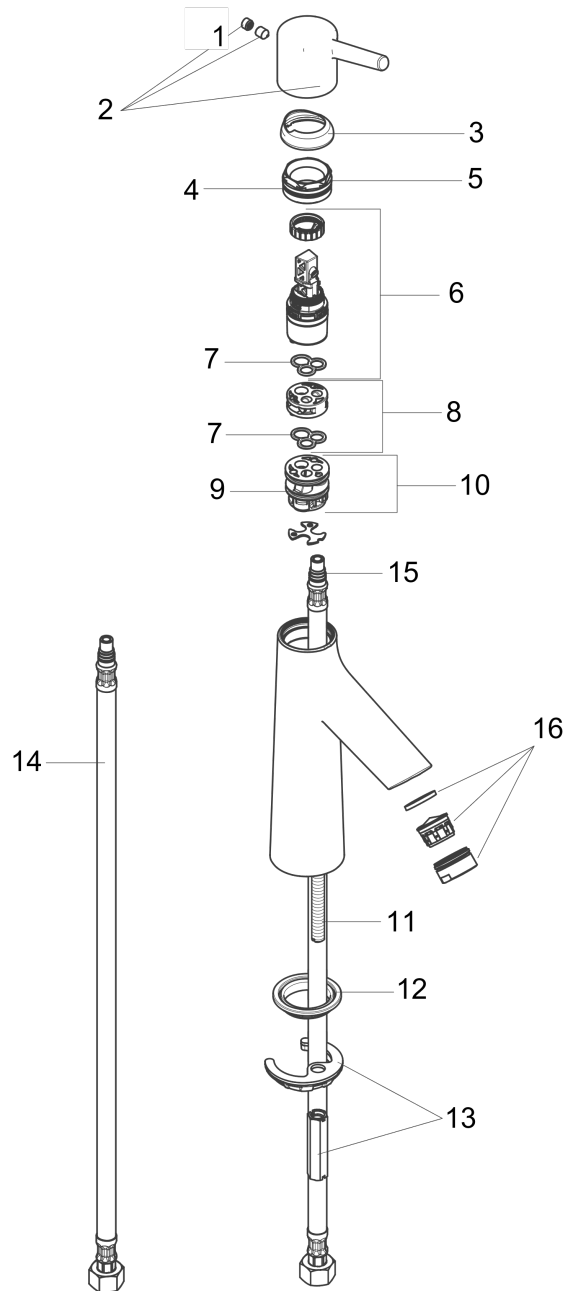

Talis S
Single-Hole Faucet 80, 1.0 GPM
 Finishes : **chrome** Part no. : **72018001**



Spare parts list

Year of production: >08/16

Pos.	Description	Part no.	Price	PU
1	screw cover	95704000	-	1
2	handle	92626000	-	1
3	flange	92625000	-	1
4	O-ring 27x1,5	92527000	-	1
5	nut	92627000	-	1
6	cartridge, assy	95973001	-	1
7	seal	98865000	-	1
8	adapter for cartridge	92628000	-	1
9	O-ring 23x2	98398000	-	1
10	adapter for cartridge	98866000	-	1
11	screw M8 x 68	97736000	-	1
12	seal Ø 42	98722000	-	1
13	fixing set	96016000	-	1
14	connection hose 18½" M8x0,75 3/8"	96321001	-	1
15	O-ring 7x1,5	98422000	-	1
16	aerator M24x1	98453000	-	1