



### Features

- End drain.
- Slotted overflow for deep soaking.
- Comfort Depth® design offers a 19" (483 mm) step-over height.
- Integral lumbar support and armrests for comfort.

### Hydrotherapy

- 120 BubbleMassage™ airjets.
- Automatic purge cycles remove residual water from air channels after use.
- Built-in 300 W heater.
- Lighted keypad control.

### Installation

- Drop-in

### Required Accessories

K-7271 Brass Slotted Overflow Bath Drain

or

K-7272 PVC Slotted Overflow Bath Drain

### Recommended Accessories

K-1446 Remote Installation Kit

K-9529 Removable Bath Seat

K-24916 Wireless Music Kit



ADA

### Codes/Standards

CSA B45.5/IAPMO Z124

ASTM E162

ASTM E662

UL 1795

Greenguard UL 2818 - Gold

ADA

ICC/ANSI A117.1









CARB P2

### KOHLER® One-Year Limited Warranty

See website for detailed warranty information.

### Available Color/Finishes

*Color tiles intended for reference only.*

Color	Code	Description
	0	White
	96	Biscuit
	47	Almond
	NY	Dune
	95	Ice™ Grey
	G9	Sandbar
	33	Mexican Sand™
	K4	Cashmere
	58	Thunder™ Grey

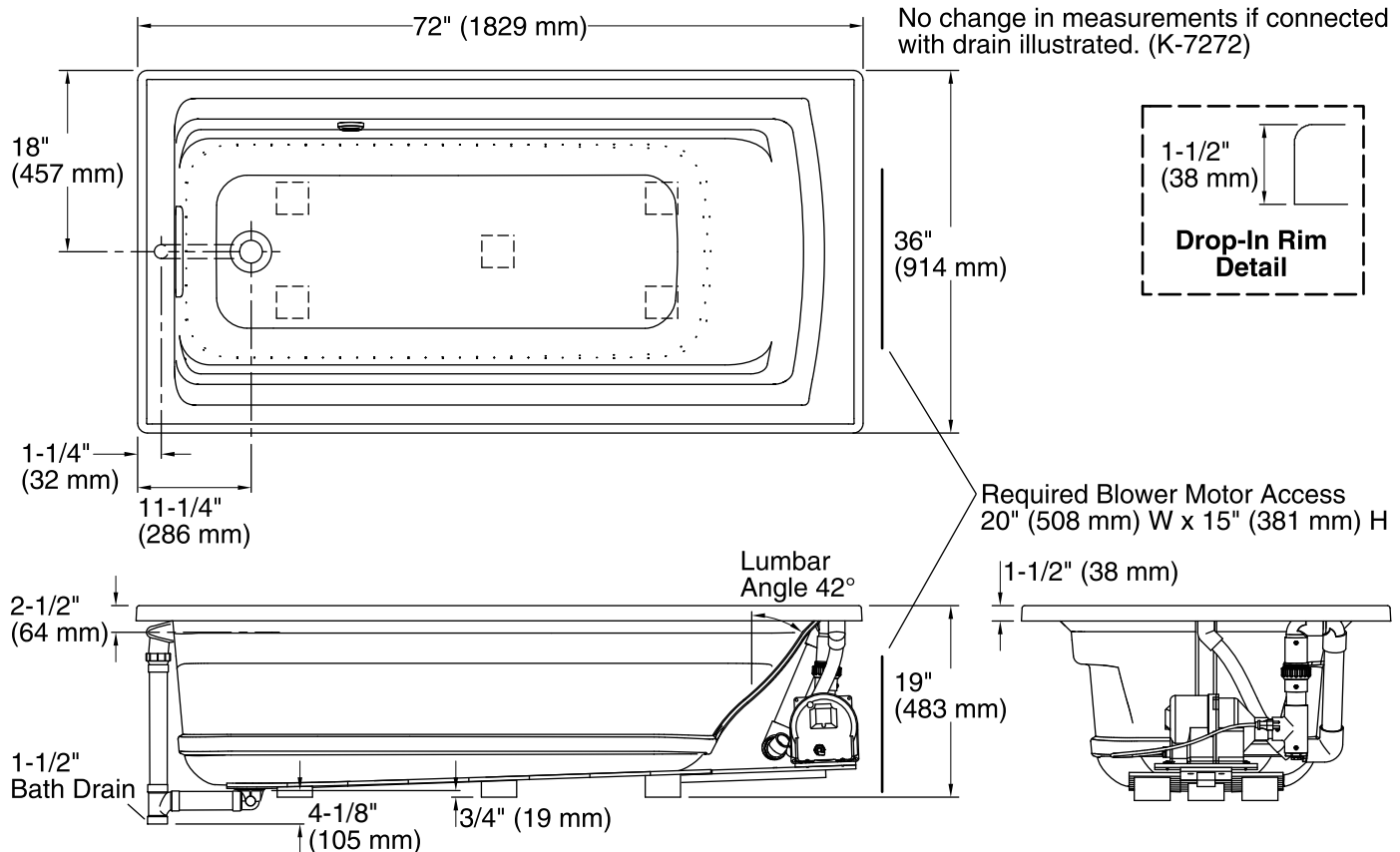

### Required Electrical Service

One dedicated circuit required, protected with Class A Ground-Fault Circuit-Interrupter (GFCI) or Residual Current Device (RCD).

Blower: 120 V, 15 A, 60 Hz

### Technical Information

All product dimensions are nominal.

Installation:	Drop-in
Drain location:	End
Basin area, bottom:	51-3/8" x 21" (1305 mm x 533 mm)
Basin area, top:	64-1/2" x 30-1/2" (1638 mm x 775 mm)
Weight:	100 lbs (45.4 kg)
Minimum floor load:	41 lbs/ft <sup>2</sup> (200.2 kg/m <sup>2</sup> )
Water depth:	15" (381 mm)
Water capacity:	72 gal (272.5 L)
Cutout:	Drop-in, 70-1/2" x 34-1/2" (1791 mm x 876 mm)
Electrical component rating:	Blower: 120 V, 10 A, 60 Hz, 300 W
Minimum flat for door:	1-9/16" (40 mm)

### Notes

Measure your actual product for rough-in details.

Install this product according to the installation instructions.

The hot water supply should be 70% of the capacity of the bath or greater. Installations will vary.

Provide one grounded electrical outlet within 24" (610 mm) of each component.

This product is designed for drop-in installation only. It is not suited for use in a three-wall alcove with an overhead shower.

Remote blower installation kit is available for relocating the blower. Provide access for servicing the blower.

Do not relocate or alter the PVC tee or coiled flexible tubing connected to the blower. Follow the blower relocation instructions exactly.

ADA compliant when installed to the specific requirements of these regulations.