

#### Features

- KOHLER finishes resist corrosion and tarnish.
- 12- inch bar.
- Wide 1-1/4- inch handle for a comfortable grip.
- Transitional styling matches any decor.
- ADA compliant when installed per ADA guidelines.
- 14-13/16" (376 mm) x 2-3/4" (70 mm) x 2-13/16" (71 mm)

#### Material

- Premium metal construction.

#### Components

Additional included component/s: Installation hardware.



ADA CSA B651 OBC

#### Codes/Standards

ADA  
ICC/ANSI A117.1  
CSA B651  
OBC

#### KOHLER® Faucet Lifetime Limited Warranty

See website for detailed warranty information.

#### Available Color/Finishes

*Color tiles intended for reference only.*

Color	Code	Description
	S	Polished Stainless
	BN	Vibrant® Brushed Nickel
	BS	Brushed Stainless
	BV	Vibrant® Brushed Bronze

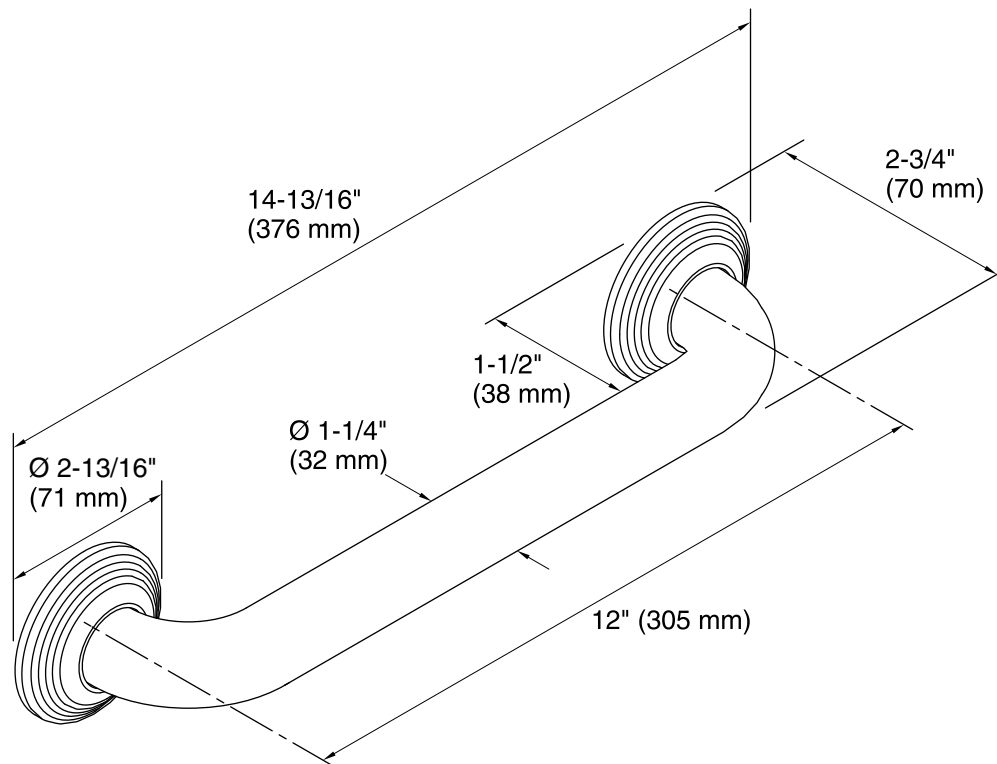

#### Technical Information

All product dimensions are nominal.

#### Notes

Measure your actual product for roughing-in details.

**WARNING:** Risk of personal injury. The wall plates on the grab bar must be mounted to a brace between the wall studs. This will ensure that the weight of the user is adequately supported.

ADA, OBC, CSA B651 compliant when installed to the specific requirements of these regulations.