



Features

- Corner layout minimizes footprint without compromising bathing area.
- Center drain.
- Integral lumbar support and armrests for comfort.
- 54" (1372 mm) x 54" (1372 mm) x 20" (508 mm)

Material

- Acrylic

Hydrotherapy

- Single-speed whirlpool offers six fully adjustable hydro-massage jets for water flow and direction.
- Built-in 1500 W heater.
- Pump with air switch for whirlpool.

Installation

- Drop-in

Recommended Accessories

- K-11677 Bath Drain
- K-7213 27" Cable Bath Drain
- K-7214 27" Cable Bath Drain
- K-24916 Wireless Music Kit
- K-1491 Bath/Whirlpool Pillow
- K-1601 Bath/Whirlpool Footstop
- K-7259 Clearflo Bath Drain
- K-7265 Clearflo Bath Drain
- K-9696 Whirlpool 6-Jet Trim Kit



Codes/Standards

- ASME A112.19.7/CSA B45.10
- CSA B45.5/IAPMO Z124
- UL 1795
- Greenguard UL 2818 - Gold
- CARB P2



KOHLER® One-Year Limited Warranty

See website for detailed warranty information.

Available Color/Finishes

Color tiles intended for reference only.

Color Code Description

	0	White
	96	Biscuit
	47	Almond

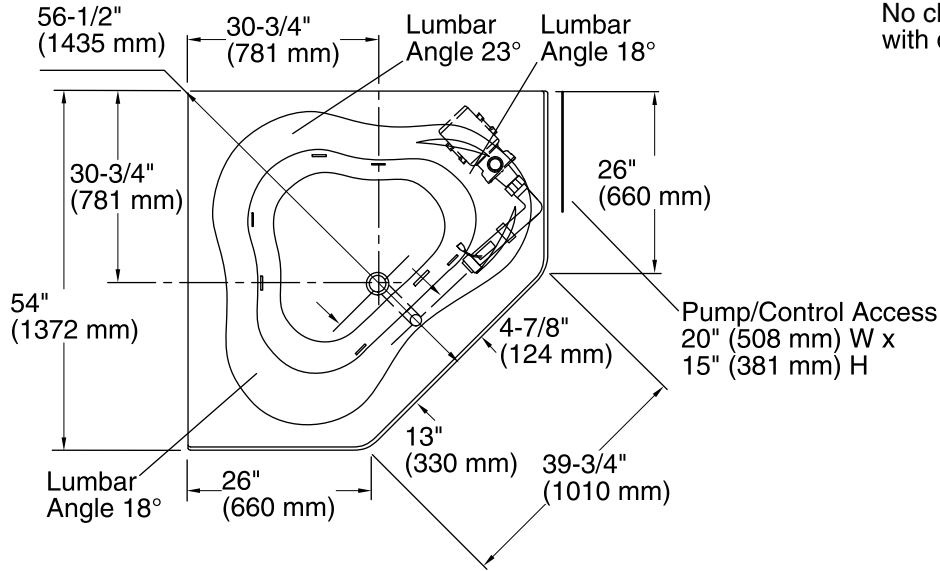

No change in measurements if connected with drain illustrated. (K-11677)

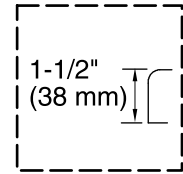

Drop-in Rim Detail

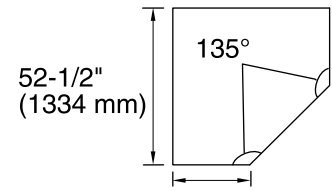

Cut-out Detail Drop-in Rim Style

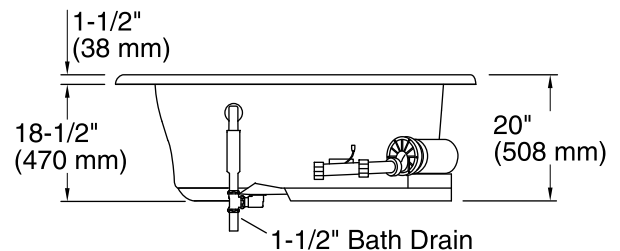
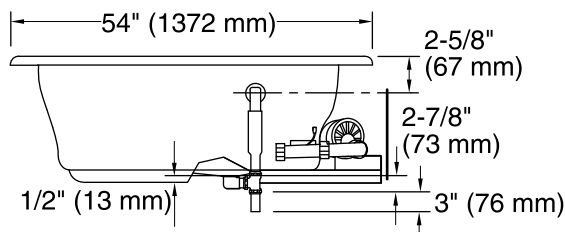

Required Electrical Service

Two dedicated circuits required, protected with Class A Ground-Fault Circuit-Interrupter (GFCI) or Residual Current Device (RCD).

Pump: 120 V, 15 A, 60 Hz
Heater: 120 V, 15 A, 60 Hz

Technical Information

All product dimensions are nominal.

Installation: Corner, Drop-in
Drain location: Center
Basin area, bottom: 44" x 36" (1118 mm x 914 mm)
Basin area, top: 56" x 43" (1422 mm x 1092 mm)
Weight: 70 lbs (31.8 kg)
Minimum floor load: 36 lbs/ft² (175.8 kg/m²)
Water depth: 15" (381 mm)
Water capacity: 76 gal (287.7 L)
Electrical component rating: Pump: 120 V, 7.5 A, 60 Hz
Heater: 120 V, 12.5 A, 60 Hz, 1500 W
Pump speed: Single
Minimum flat for door: 0" (0 mm)

Notes

Measure your actual product for rough-in details.

Install this product according to the installation instructions.

The hot water supply should be 70% of the capacity of the bath or greater. Installations will vary.

Provide one grounded electrical outlet within 24" (610 mm) of each component.