



Features

- End drain.
- Integral lumbar support and armrests for comfort.
- 60" (1524 mm) x 42" (1067 mm) x 21" (533 mm)

Material

- Acrylic

Hydrotherapy

- Single-speed whirlpool offers six fully adjustable hydro-massage jets for water flow and direction.
- Pump with air switch for whirlpool.

Installation

- Drop-in



Recommended Accessories

- K-11677 Bath Drain
- K-1491 Bath/Whirlpool Pillow
- K-1601 Bath/Whirlpool Footstop
- K-576 Under-mount Install Kit
- K-24916 Wireless Music Kit
- K-7213 27" Cable Bath Drain
- K-7214 27" Cable Bath Drain
- K-9696 Whirlpool 6-Jet Trim Kit
- K-37382 45" Rough-in Cable Bath Drain

Codes/Standards





- ASME A112.19.7/CSA B45.10
- CSA B45.5/IAPMO Z124
- ASTM E162
- ASTM E662
- UL 1795
- Greenguard UL 2818 - Gold
- CARB P2

KOHLER® One-Year Limited Warranty

See website for detailed warranty information.

Available Color/Finishes

Color tiles intended for reference only.

Color	Code	Description
	0	White
	96	Biscuit
	47	Almond
	G9	Sandbar

No change in measurements if connected with drain illustrated. (K-11677)

■ Recommended faucet area

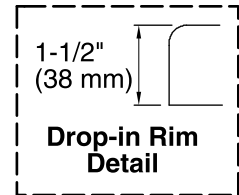
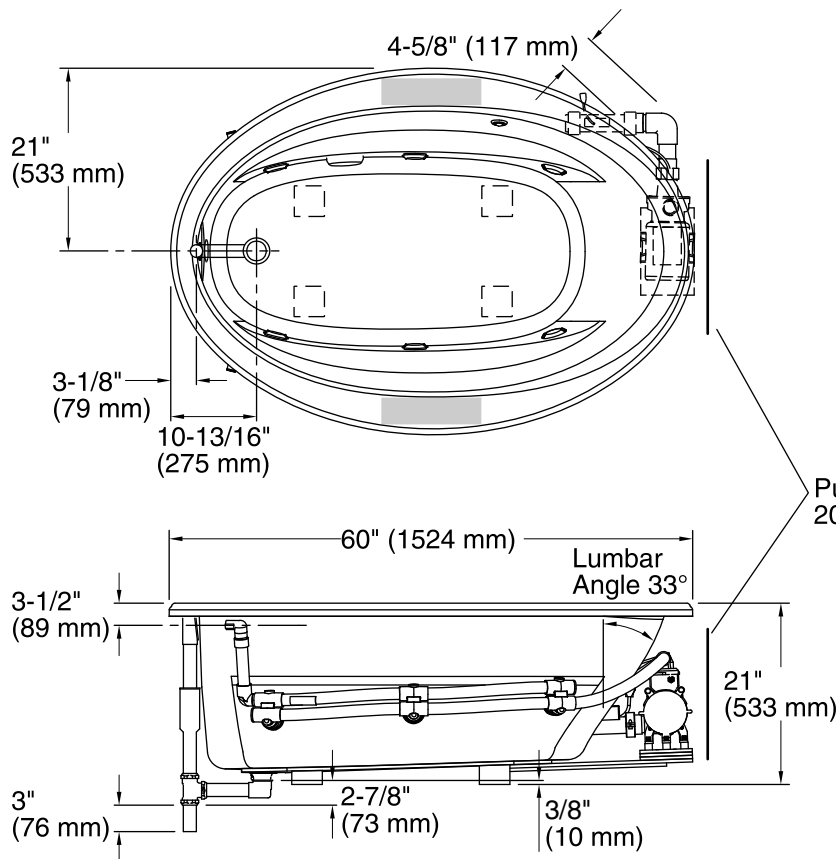

Pump/Control Access
20" (508 mm) W x 15" (381 mm) H

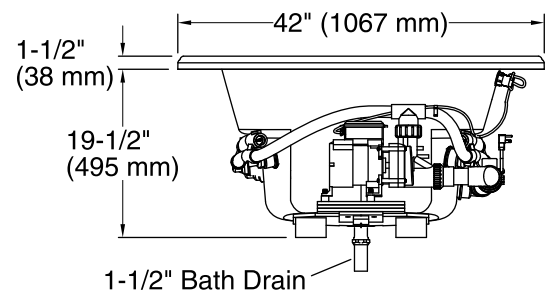

Required Electrical Service

One dedicated circuit required, protected with Class A Ground-Fault Circuit-Interrupter (GFCI) or Residual Current Device (RCD).

Pump: 120 V, 15 A, 60 Hz

Technical Information

All product dimensions are nominal.

Installation:	Drop-in
Drain location:	End
Basin area, bottom:	43" x 21-9/16" (1092 mm x 548 mm)
Basin area, top:	53-1/2" x 32-1/8" (1359 mm x 816 mm)
Weight:	110 lbs (49.9 kg)
Minimum floor load:	35 lbs/ft ² (170.9 kg/m ²)
Water depth:	15" (381 mm)
Water capacity:	57 gal (215.8 L)
Template:	Drop-in, 1042556-7, required, included
Electrical component rating:	Pump: 120 V, 7.5 A, 60 Hz
Pump speed:	Single
Minimum flat for door:	0" (0 mm)

Notes

Measure your actual product for rough-in details.

Install this product according to the installation instructions.

The hot water supply should be 70% of the capacity of the bath or greater. Installations will vary.

Provide one grounded electrical outlet within 24" (610 mm) of each component.

The suction line extends 4-5/8" (117 mm) beyond the edge of the rim. The pump base extends 1/8" (3 mm) beyond the edge of the rim. Modify the framing as needed.