



### Features

- Center drain.
- Integral lumbar support.
- Coordinates with other products in the Escale® collection.
- 72" (1829 mm) x 36" (914 mm) x 24-1/8" (613 mm)

### Material

- Acrylic

### Hydrotherapy

- 120 BubbleMassage™ airjets.
- Automatic and manual purge cycles remove residual water from air channels after use.
- Built-in 300 W heater.

### Installation

- Freestanding
- Two-piece design.

### Required Accessories

K-7219 Bath Drain

### Recommended Accessories

K-1601 Bath/Whirlpool Footstop  
K-1676 Bath/Pillow  
K-922  
K-923 Bath Filler  
K-24916 Wireless Music Kit



### Codes/Standards



ASME A112.19.7/CSA B45.10  
CSA B45.5/IAPMO Z124  
ASTM E162  
ASTM E662  
UL 1795  
Greenguard UL 2818 - Gold  
CARB P2

### KOHLER® One-Year Limited Warranty

See website for detailed warranty information.

### Available Color/Finishes

*Color tiles intended for reference only.*

Color	Code	Description
	0	White
	96	Biscuit
	47	Almond

No change in measurements if connected with drain illustrated. (K-7219)

**A** Recommended floor-mount bath filler location.

**B** Recommended ceiling-mount bath filler location.

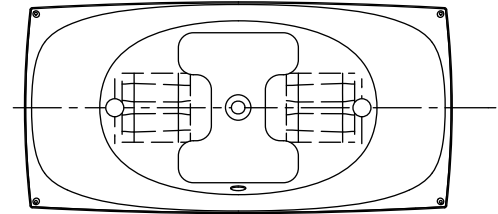
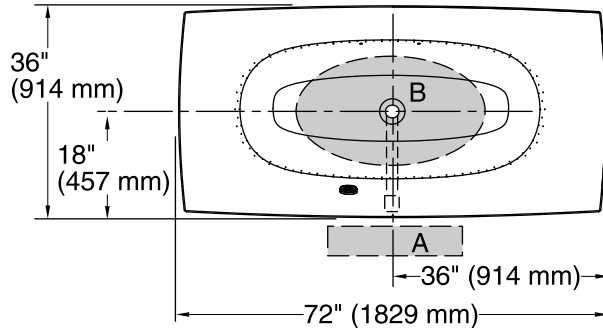

**Bottom View**

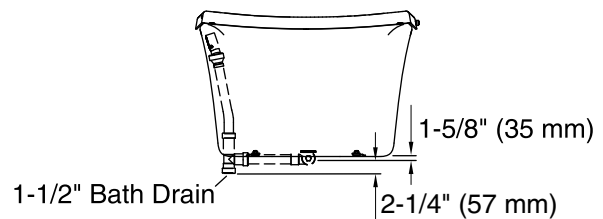
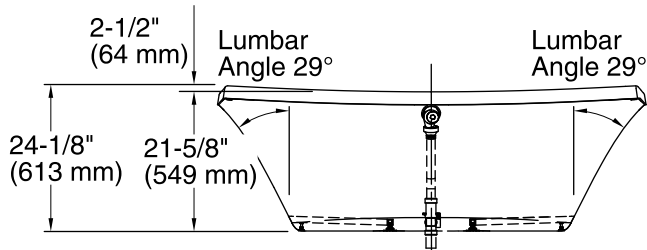

### Required Electrical Service

One dedicated circuit required, protected with Class A Ground-Fault Circuit-Interrupter (GFCI) or Residual Current Device (RCD).

Blower: 120 V, 15 A, 60 Hz

### Technical Information

All product dimensions are nominal.

Installation: Freestanding  
 Drain location: Center  
 Basin area, bottom: 46-3/4" x 21-5/8" (1187 mm x 549 mm)  
 Basin area, top: 69-15/16" x 34-3/8" (1776 mm x 873 mm)  
 Weight: 130 lbs (59 kg)  
 Minimum floor load: 41.5 lbs/ft<sup>2</sup> (202.6 kg/m<sup>2</sup>)  
 Water depth: 16-1/2" (419 mm)  
 Water capacity: 71 gal (268.8 L)  
 Electrical component rating: Blower: 120 V, 10 A, 60 Hz, 300 W  
 Minimum flat for door: 0" (0 mm)

### Notes

Measure your actual product for rough-in details.

Install this product according to the installation instructions.

The hot water supply should be 70% of the capacity of the bath or greater. Installations will vary.

Provide one grounded electrical outlet within 24" (610 mm) of each component.

Blower motor requires remote installation.

Relocate the blower motor and check valve together. Do not move one without the other. Provide access for servicing the blower.