

Features

- For single-hole installation or 4-inch centers with escutcheon (add "optional" escutcheon plate included).
- KOHLER ceramic disc valves exceed industry longevity standards two times for a lifetime of durable performance.
- KOHLER finishes resist corrosion and tarnishing, exceeding industry durability standards two times.
- Completes Devonshire design solution with KOHLER fixtures and accessories.
- Temperature memory allows faucet to be turned on and off at any temperature setting

Material

- Premium material construction for durability and reliability.

Installation

- Pop-up drain with lift rod and tailpiece
- Flexible connections for easy installation

Water Conservation & Rebates

- Low-flow aerator option available (please see latest price book).
- 1.2 gal/min (4.5 l/min) maximum flow rate [max at 60 psi (4.14 bar)].

Adapters, Rough-in and Extension Kits

1223297_1



ADA **CSA B651** **OBC**

Codes/Standards

ASME A112.18.1/CSA B125.1
NSF 61
NSF 372

All applicable US Federal and State material regulations

DOE - Energy Policy Act 1992

EPA WaterSense®

California Energy Commission (CEC)

ADA

ICC/ANSI A117.1

CSA B651







OBC

KOHLER® Faucet Lifetime Limited Warranty

See website for detailed warranty information.

Available Color/Finishes

Color tiles intended for reference only.

| Color | Code | Description |
|--|------|--------------------------|
|  | CP | Polished Chrome |
|  | SN | Vibrant® Polished Nickel |
|  | PB | Vibrant® Polished Brass |
|  | BN | Vibrant® Brushed Nickel |
|  | BV | Vibrant® Brushed Bronze |
|  | 2BZ | Oil-Rubbed Bronze |

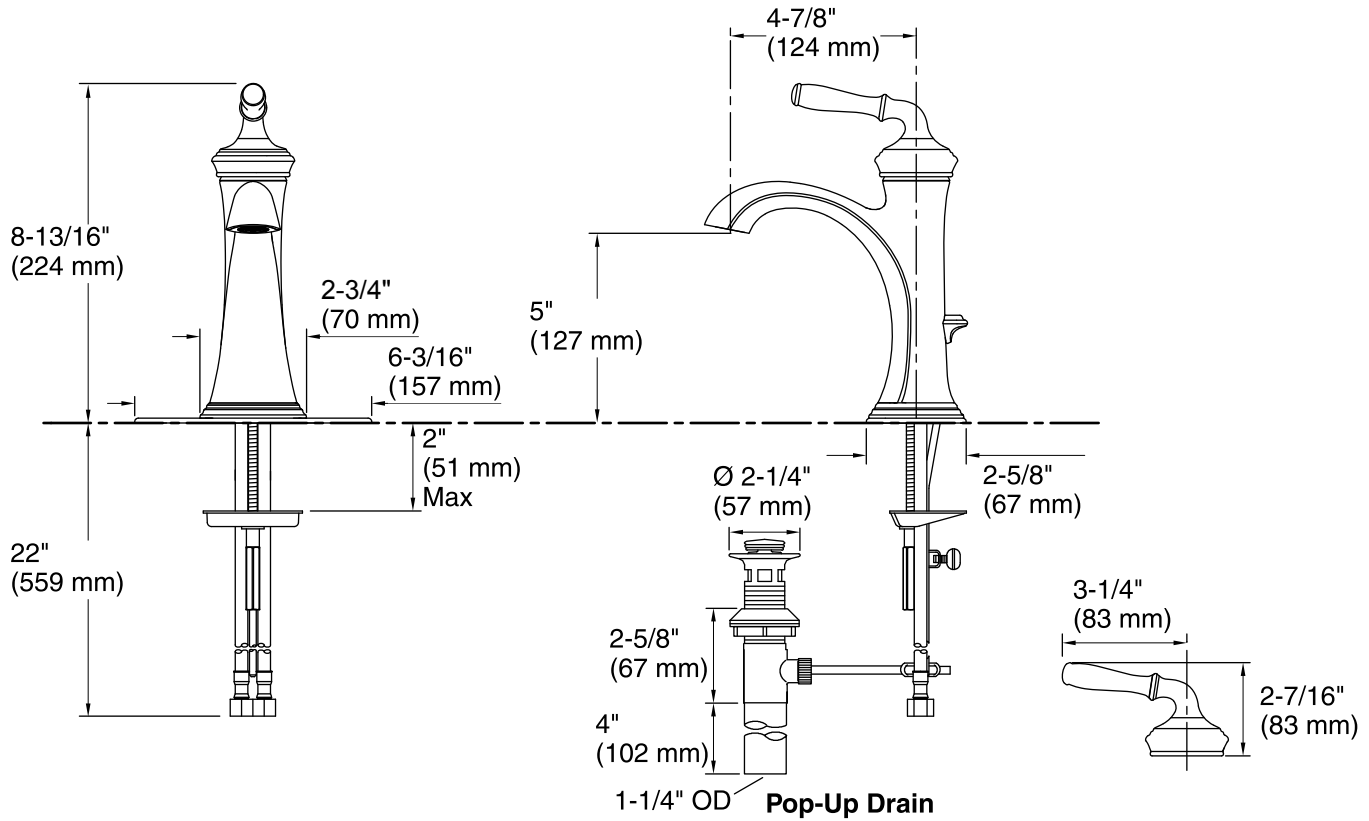

Technical Information

All product dimensions are nominal.

Drain included: YES

Drain tailpiece included: YES

Spout:

Spout reach: 4-7/8" (124 mm)

Faucet:

Flow rate: 1.2 gal/min (4.5 l/min)

Pressure: 60 psi (4.1 bar)

Notes

Install this product according to the installation guide.

ADA, OBC, CSA B651 compliant when installed to the specific requirements of these regulations.