



### Features

- Integral flange.
- Right drain.
- Low threshold shower base.
- One-piece construction.
- Integral seat.
- Textured bottom surface.
- Coordinates with other products in the Tresham® collection.
- Coordinates with Choreograph™ walls.

### Material

- Acrylic
- Reinforced with fiberglass (FRP).

### Installation

- Alcove

### Required Accessories

K-9132 Shower Drain

### Recommended Accessories

- K-1733 9 kW Steam Generator
- K-702206-G54 Frameless Sliding Shower Door
- K-702206-G73 Frameless Sliding Shower Door
- K-702206-L Frameless Sliding Shower Door
- K-702207-L Frameless Sliding Shower Door
- K-702217-L Frameless Sliding Shower Door
- K-705705-L Frameless Pivot Shower Door
- K-705711-L Frameless Pivot Shower Door
- K-705717-L Frameless Pivot Shower Door
- K-705723-L Frameless Pivot Shower Door
- K-705729-L Frameless Pivot Shower Door
- K-705741-L Frameless Pivot Shower Door
- K-705810-L Semi-Frameless Pivot Shower Door
- K-705811-L Semi-Frameless Pivot Shower Door
- K-705824-L Semi-Frameless Pivot Shower Door
- K-705825-L Semi-Frameless Pivot Shower Door
- K-706009-D3 Frameless Sliding Shower Door
- K-706009-L Frameless Sliding Shower Door
- K-706012-L Frameless Sliding Shower Door
- K-706013-L Frameless Sliding Shower Door
- K-706015-D3 Frameless Sliding Shower Door
- K-706015-L Frameless Sliding Shower Door
- K-706019-L Frameless Sliding Shower Door

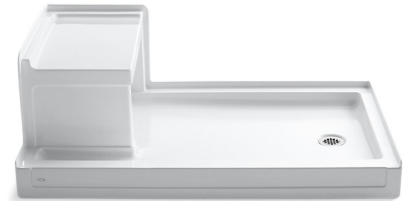

### Codes/Standards







CSA B45.5/IAPMO Z124  
ASTM E162  
ASTM E662  
Greenguard UL 2818 - Gold

### KOHLER® One-Year Limited Warranty

See website for detailed warranty information.

### Available Color/Finishes

*Color tiles intended for reference only.*

Color	Code	Description
	0	White
	96	Biscuit
	47	Almond
	NY	Dune
	95	Ice™ Grey
	G9	Sandbar

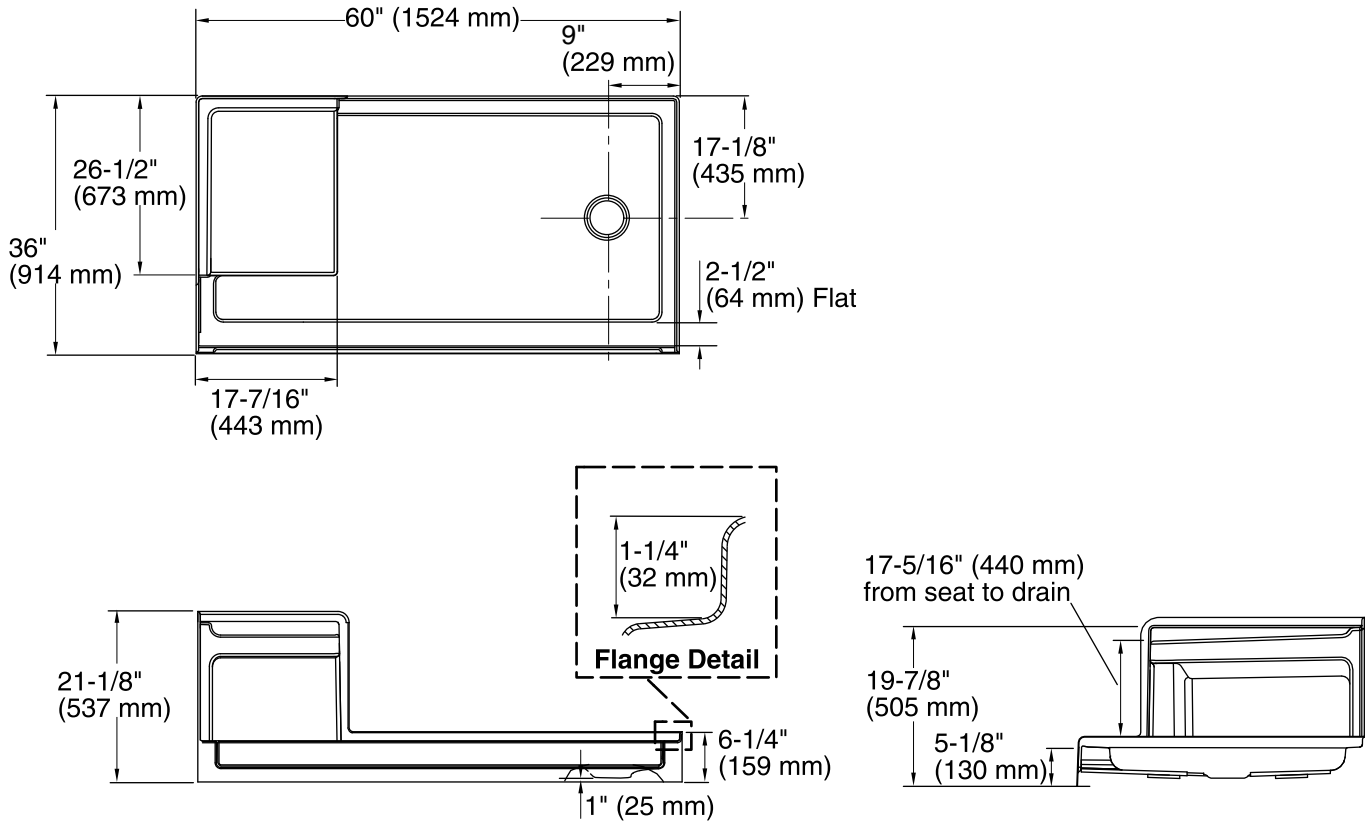

## Technical Information

All product dimensions are nominal.

Installation:	3-Wall Alcove
Drain location:	Right
Drain hole diameter:	3-3/8" (86 mm)
Weight:	79.5 lbs (36.1 kg)
Minimum floor load:	20 lbs/ft <sup>2</sup> (97.6 kg/m <sup>2</sup> )
Minimum flat for door:	0" (0 mm)

## Notes

Measure your actual product for rough-in details.

Install this product according to the installation instructions.

Shimming may be required between the stud frame and the fixture.

Stud opening tolerance is +1/4" (6 mm), -0" (0 mm).

KOHLER steam generator/control kit are designed for use with this product. Kohler Co. shall not be responsible for problems encountered due to the installation and use of other manufacturer's steam generators.