



**Devonshire®**  
Undermount Bathroom Sink  
**K-2336**

**Features**

- Vitreous china.
- Under-mount.
- Oval basin.
- No faucet holes; requires wall- or counter-mount faucet.
- Coordinates with other products in the Devonshire collection.
- 18-1/8" (460 mm) x 14" (356 mm)

**Recommended Accessories**

K-9018 P-Trap

**Components**

Product includes:  
1193643 Basin Clamps



ADA

**Codes/Standards**











ASME A112.19.2/CSA B45.1  
ADA  
ICC/ANSI A117.1

**KOHLER® One-Year Limited Warranty**

See website for detailed warranty information.

**Available Color/Finishes**

*Color tiles intended for reference only.*

Color	Code	Description
	0	White
	96	Biscuit
	47	Almond
	NY	Dune
	95	Ice™ Grey
	G9	Sandbar
	33	Mexican Sand™
	K4	Cashmere
	58	Thunder™ Grey
	7	Black Black™

USA/Canada: 1-800-4KOHLER (1-800-456-4537)

Kohler Co. reserves the right to make revisions without notice to product specifications.

For the most current Specification Sheet, go to [www.kohler.com](http://www.kohler.com).

1-14-2017 02:55

THE BOLD LOOK  
OF **KOHLER**®

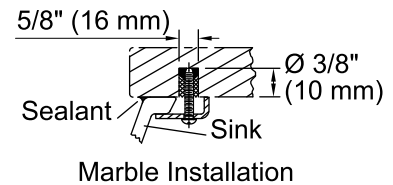
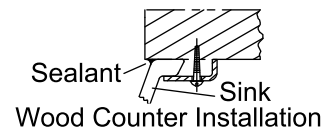
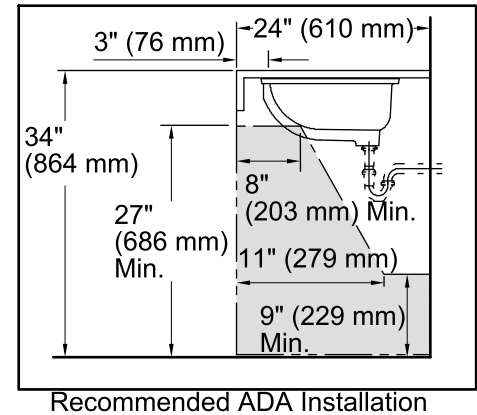
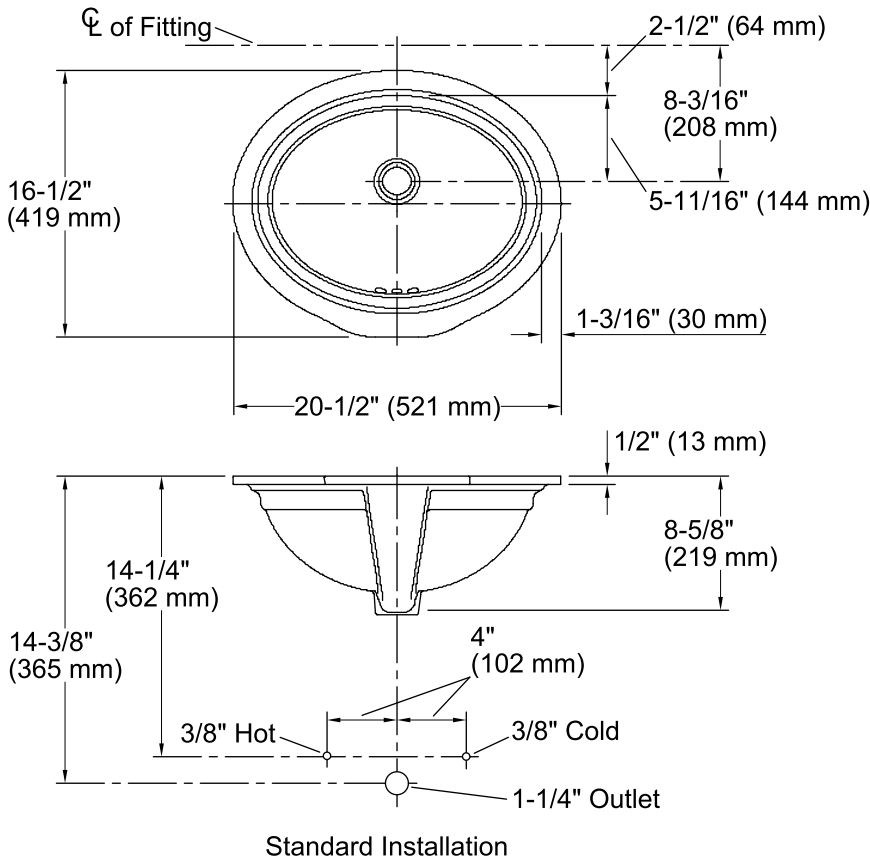

### Technical Information

All product dimensions are nominal.

Bowl configuration:	Single
Installation:	Under-mount
Bowl area (Only)	Length: 18-1/8" (460 mm) Width: 14" (356 mm) Water depth: 4-3/16" (106 mm)
Drain hole:	1-3/4" (44 mm)
Template:	1050263-7, required, not included

### Notes

Install this product according to the installation instructions.

**NOTICE:** Countertop manufacturer or cutter must use the current product template available at [www.kohler.com](http://www.kohler.com), or by calling 1-800-4KOHLER. Kohler Co. is not responsible for cutout errors when the incorrect cutout template is used.

ADA compliant when installed to the specific requirements of these regulations.