

Features

- KOHLER cast iron
- With overflow
- 8" (203 mm) centers
- 19" (483 mm) diameter



ADA CSA B651 OBC

Codes/Standards













ASME A112.19.1/CSA B45.2
ADA
ICC/ANSI A117.1
CSA B651
OBC

KOHLER® Lifetime Limited Warranty for Cast Iron Components

See website for detailed warranty information.

Available Color/Finishes

Color tiles intended for reference only.

Color	Code	Description
	0	White
	FF	Sea Salt™
	96	Biscuit
	47	Almond
	FD	Cane Sugar™
	NY	Dune
	95	Ice™ Grey
	G9	Sandbar
	FT	Basalt
	20	Suede
	KA	Black 'n Tan
	7	Black Black™

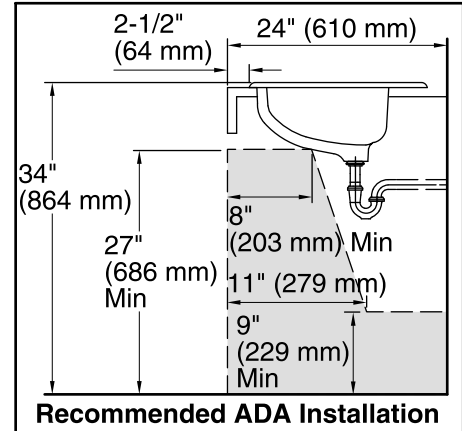
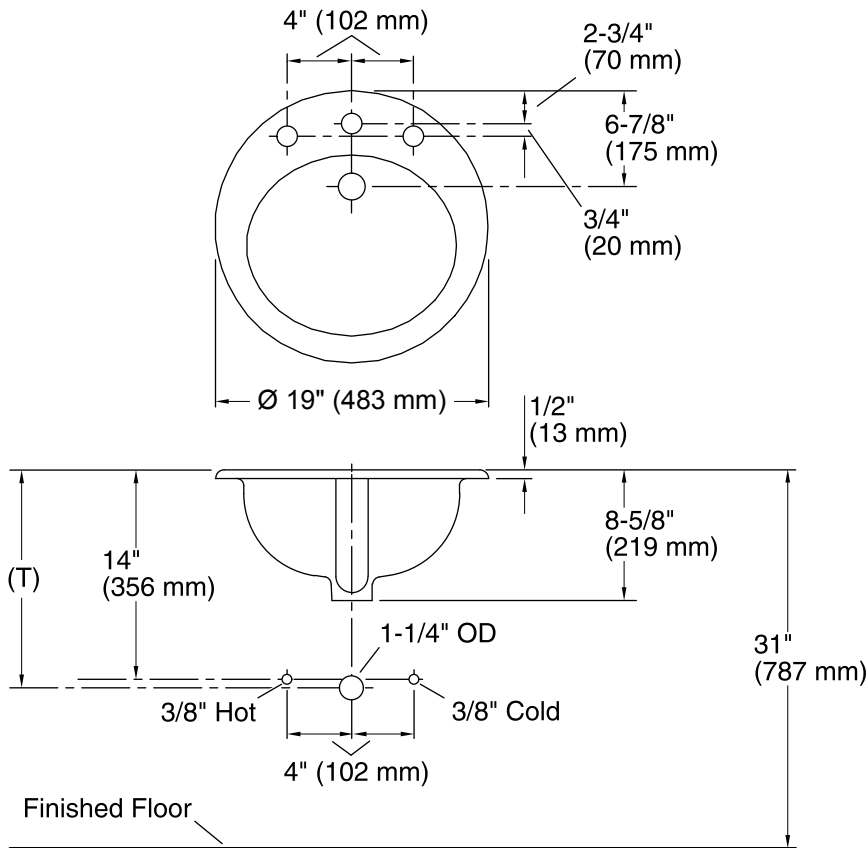

(T) Pop-up drain 14-3/16" (360 mm),
grid drain 13-5/16" (338 mm).

Technical Information

All product dimensions are nominal.

Installation:	Drop-In
Bowl area	Length: 14" (356 mm) Width: 12" (305 mm) Water depth: 5" (127 mm)
Number of deck holes:	3
Faucet hole(s):	1-3/8" (35 mm)
Drain hole:	1-11/16" (43 mm)
Template:	101082-7, required, included

Notes

Install this product according to the installation instructions.

NOTICE: Countertop manufacturer or cutter must use the current product template available at www.kohler.com, or by calling 1-800-4KOHLER. Kohler Co. is not responsible for cutout errors when the incorrect cutout template is used.

ADA, OBC, CSA B651 compliant when installed to the specific requirements of these regulations.