

### Features

- Kohler plumbing products mean beautiful form as much as reliable function.
- KOHLER ceramic disc valves exceed industry longevity standards two times for a lifetime of durable performance.
- Completes Devonshire design solution with KOHLER® fixtures and accessories.

### Material

- KOHLER finishes resist corrosion and tarnishing, exceeding industry durability standards two times.



### Codes/Standards







None Applicable

### KOHLER® Faucet Lifetime Limited Warranty

See website for detailed warranty information.

### Available Color/Finishes

*Color tiles intended for reference only.*

Color	Code	Description
	CP	Polished Chrome
	SN	Vibrant® Polished Nickel
	PB	Vibrant® Polished Brass
	BN	Vibrant® Brushed Nickel
	BV	Vibrant® Brushed Bronze
	2BZ	Oil-Rubbed Bronze

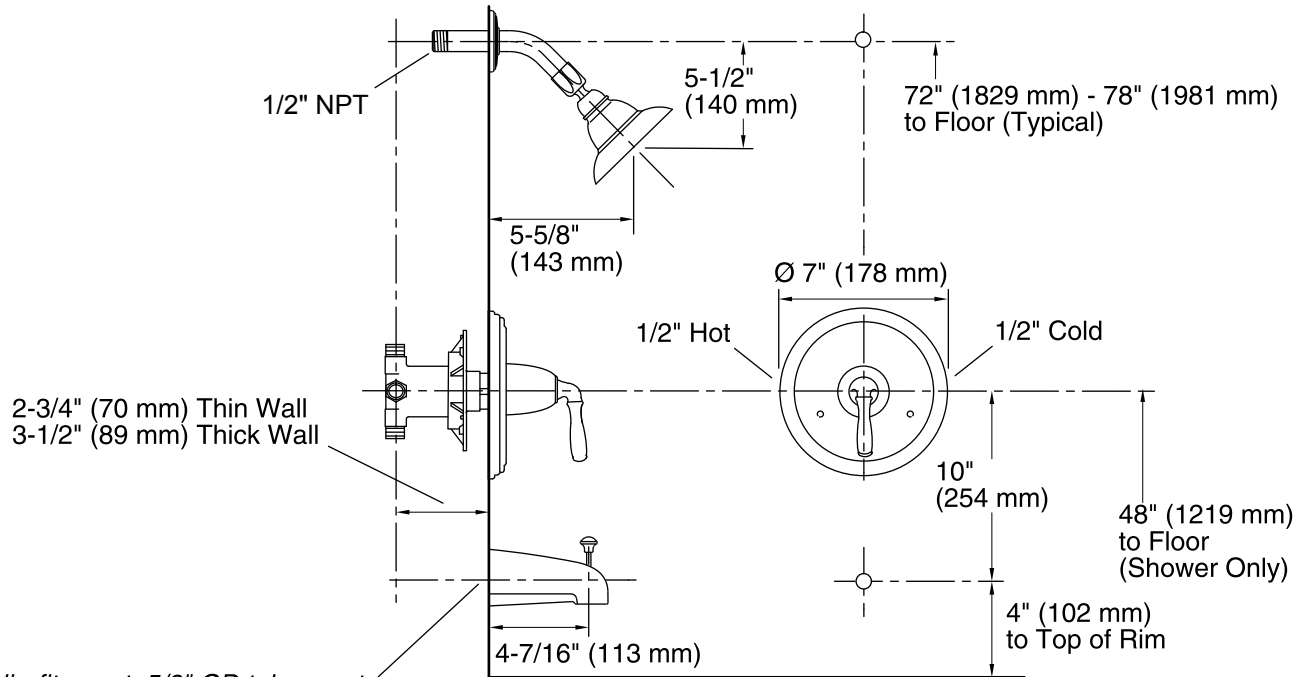

For slip-fit spout, 5/8" OD tube must extend 3-1/4" (83 mm) max beyond the finished wall.  
 For 1/2" NPT spout, pipe must extend 3-5/8" (92 mm) beyond the finished wall.

Complete bath and shower faucet with Rite-Temp valve and slip-fit diverter spout shown.

**Technical Information**

All product dimensions are nominal.

**Notes**

Install this product according to the installation guide.