



Features

- Integral flange.
- Rear center drain.
- Textured bottom surface.
- Coordinates with other products in the Memoirs collection.
- Coordinates with Choreograph™ walls.

Material

- Acrylic
- Reinforced with fiberglass (FRP).

Installation

- Corner
- Neoangle

Required Accessories

K-9132 Shower Drain



Codes/Standards











ASME A112.19.1/CSA B45.2
CSA B45.5/IAPMO Z124
ASTM E162
ASTM E662
Greenguard UL 2818 - Gold

KOHLER® One-Year Limited Warranty

See website for detailed warranty information.

Available Color/Finishes

Color tiles intended for reference only.

Color	Code	Description
	0	White
	96	Biscuit
	47	Almond
	NY	Dune
	95	Ice™ Grey
	G9	Sandbar
	33	Mexican Sand™
	K4	Cashmere
	58	Thunder™ Grey
	7	Black Black™

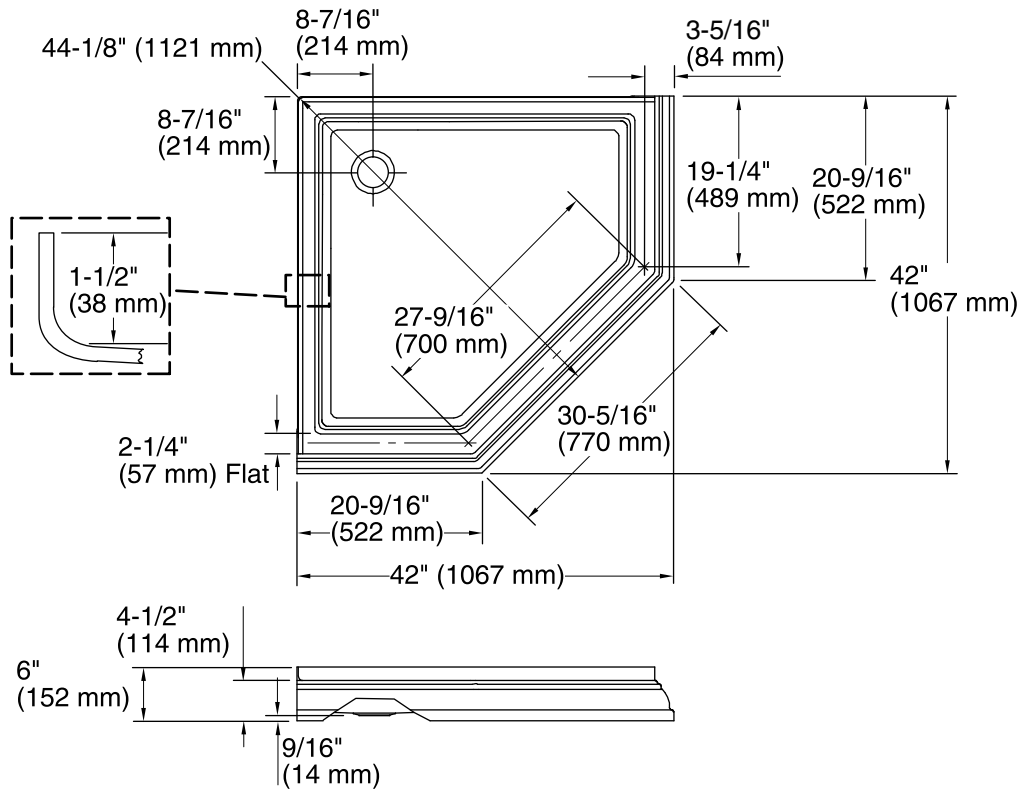

Technical Information

All product dimensions are nominal.

Installation:	Corner
Drain location:	Center rear
Drain hole diameter:	3-3/8" (86 mm)
Weight:	35 lbs (15.9 kg)
Minimum floor load:	20 lbs/ft ² (97.6 kg/m ²)
Minimum flat for door:	0" (0 mm)

Notes

Measure your actual product for rough-in details.

Install this product according to the installation instructions.

Shimming may be required to level the fixture.

Shimming may be required between the stud frame and the fixture.

Stud opening tolerance is + 1/4" (6 mm), - 0" (0 mm).