

NIBCO® FLO-BOSS™



LIST PRICE BOOK

BALANCING AND CONTROL VALVES

ABOUT

NIBCO®

AHEAD OF THE FLOW®

With the FLO-BOSS™ line of balancing valves – including automatic, manual, lead-free, and now press ends – NIBCO continues to demonstrate why we're the most reliable name in flow control.

Along with NIBCO® Coil-Connect® Kits, you'll find FLO-BOSS products are the right fit for a wide range of balancing applications. Quick-supply capabilities allow you to select the exact FLO-BOSS valves for every job so you can stay organized and work smarter.

Plus, all FLO-BOSS valves are quality tested to meet stringent NIBCO specifications, and backed by a five-year, 125% limited warranty.

Get the know-how you expect from a reliable partnership that works for you. With NIBCO sales representatives located across the United States, you always have someone who can help with everything from takeoffs to simply finding the right part.

As a vertically integrated manufacturer with plants and distribution centers nationwide, our superb logistics and customer service capabilities mean the FLO-BOSS valves you need are readily available when you need them.

Founded in 1904, NIBCO has grown to become a leading global provider of valves, fittings, and flow control products for commercial, industrial, and institutional construction as well as residential and irrigation markets.

When every detail matters, choose FLO-BOSS balancing valves from the leader in flow control reliability.



TABLE OF CONTENTS

5	LEAD-FREE MANUAL BALANCING VALVES
9	MANUAL BALANCING VALVES
15	AUTOMATIC BALANCING VALVES
21	COMBINATION SHUTOFF VALVES & UNIONS
43	NIBCO® COIL-CONNECT® PREPACKAGED COIL KITS
57	BALANCING AND CONTROL OPTIONS AND ACCESSORIES

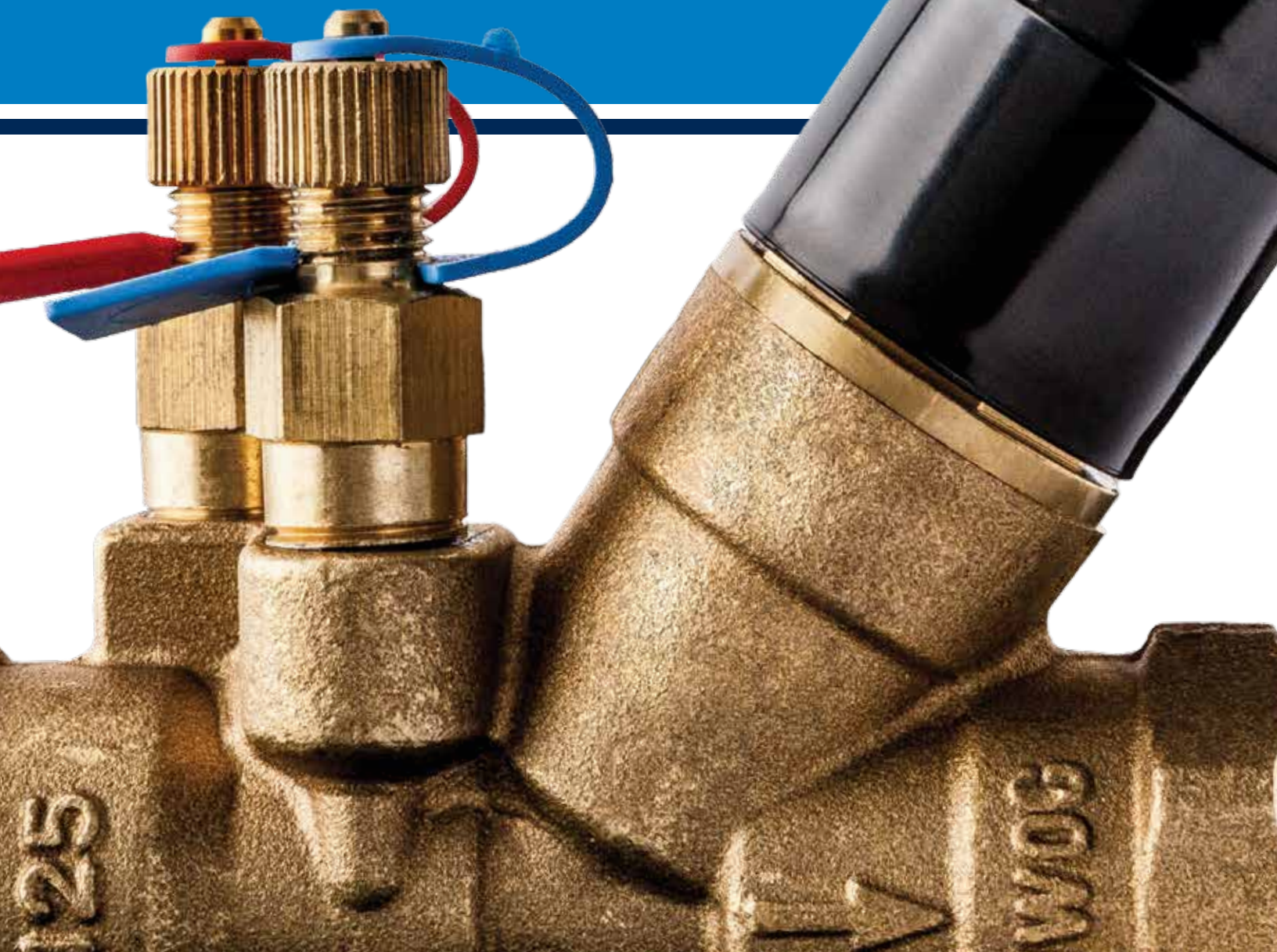

LEAD-FREE*

MANUAL BALANCING VALVES

- SPECIFICALLY DESIGNED FOR USE IN POTABLE, NON-POTABLE AND HYDRONIC SYSTEMS
- CERTIFIED TO NSF/ANSI 61 AND 372

**Weighted average lead content \leq 0.25%*



LEAD-FREE* MANUAL BALANCING VALVES



NSF/ANSI 61
NSF/ANSI 372

FLO-BOSS™ M

Lead-Free* DZR Brass Fixed Orifice Balancing Valve

1810-LF Series – Thread Ends

Ratings

300 PSI Non-Shock Cold Working Pressure
Maximum Temperature 260°F at 150 PSI

Features

Sizes: ½ to 2"
Flow Measurement Accuracy of +/- 3%
Integral Positive Off
Memory Stop
Fixed Orifice
Location Tag

Material #	Model	Size	Inlet x Outlet Connection	Min/Max Flow Rate GPM	Weight Lbs	List Price
NL2XULX6	T-1810U-LF	½" U	FPT x FPT	0.24/1.0	1.16	\$ 125.00
NL1XLX6	T-1810L-LF	½" L	FPT x FPT	0.52/2.0	1.16	125.00
NL2X0X6	T-1810-LF	½"	FPT x FPT	1.2/5.0	1.21	125.00
NL2X0X8	T-1810-LF	¾"	FPT x FPT	2.4/10.0	1.43	127.00
NL2X0XA	T-1810-LF	1"	FPT x FPT	4.3/18.0	1.73	142.00
NL2X0XB	T-1810-LF	1¼"	FPT x FPT	9.0/33.0	2.78	209.00
NL2X0XC	T-1810-LF	1½"	FPT x FPT	13/49.0	3.50	252.00
NL2X0XD	T-1810-LF	2"	FPT x FPT	24/78.0	4.80	348.00



NSF/ANSI 61
NSF/ANSI 372

FLO-BOSS™ M

Lead-Free* DZR Brass Fixed Orifice Balancing Valve

1810-LF Series – Solder Ends

Ratings

300 PSI Non-Shock Cold Working Pressure
Maximum Temperature 260°F at 150 PSI

Features

Sizes: ½ to 2"
Flow Measurement Accuracy of +/- 3%
Integral Positive Off
Memory Stop
Fixed Orifice
Location Tag

Material #	Model	Size	Inlet x Outlet Connection	Min/Max Flow Rate GPM	Weight Lbs	List Price
NJ2XULX6	S-1810U-LF	½" U	SWT x SWT	0.24/1.0	1.21	\$ 125.00
NJ1XLX6	S-1810L-LF	½" L	SWT x SWT	0.52/2.0	1.21	125.00
NJ2X0X6	S-1810-LF	½"	SWT x SWT	1.2/5.0	1.15	125.00
NJ2X0X8	S-1810-LF	¾"	SWT x SWT	2.4/10.0	1.30	127.00
NJ2X0XA	S-1810-LF	1"	SWT x SWT	4.3/18.0	1.55	142.00
NJ2X0XB	S-1810-LF	1¼"	SWT x SWT	9.0/33.0	2.52	209.00
NJ2X0XC	S-1810-LF	1½"	SWT x SWT	13/49.0	3.16	252.00
NJ2X0XD	S-1810-LF	2"	SWT x SWT	24/78.0	4.46	348.00

*Weighted average lead content ≤ 0.25%



NSF/ANSI 61
NSF/ANSI 372

FLO-BOSS™ M

Lead-Free* DZR Brass Fixed Orifice Balancing Valve

1810-LF Series – Press Ends

Ratings

200 PSI Non-Shock Cold Working Pressure
Maximum Temperature 250°F at 150 PSI

Features

Sizes: ½ to 2"
Flow Measurement Accuracy of +/- 3%
Integral Positive Off
Memory Stop
Fixed Orifice
Location Tag

Material #	Model	Size	Inlet/Outlet Connection	Min/Max Flow Rate GPM	Weight Lbs	List Price
NMP1XUX6	PC1810U-LF	½" U	PRESS x PRESS	0.24/1.0	1.37	\$ 168.00
NMP1XPX6	PC1810L-LF	½" L	PRESS x PRESS	0.52/2.0	1.37	168.00
NMP2X0X6	PC1810-LF	½"	PRESS x PRESS	1.2/5.0	1.42	168.00
NMP2X0X8	PC1810-LF	¾"	PRESS x PRESS	2.4/10.0	1.82	171.00
NMP2X0XA	PC1810-LF	1"	PRESS x PRESS	4.3/18.0	2.27	208.00
NMP2X0XB	PC1810-LF	1¼"	PRESS x PRESS	9.0/33.0	3.71	275.00
NMP2X0XC	PC1810-LF	1½"	PRESS x PRESS	13/49.0	4.89	318.00
NMP2X0XD	PC1810-LF	2"	PRESS x PRESS	24/78.0	6.65	396.00

*Weighted average lead content ≤ 0.25%

MANUAL BALANCING VALVES

- DEZINCIFICATION-RESISTANT FOR LONG-LASTING, CORROSION-FREE PERFORMANCE
- LARGE SELECTION OF CAST IRON FLANGED AND GROOVED VALVES ENGINEERED FOR OPTIMUM PERFORMANCE



MANUAL BALANCING VALVES



FLO-BOSS™ M

DZR Brass Fixed Orifice Balancing Valve

1810 Series – Threaded

Ratings

300 PSI Non-Shock Cold Working Pressure
Maximum Temperature 260°F at 150 PSI

Features

Sizes: ½ to 2"
Flow Measurement Accuracy of +/- 3%
Integral Positive Off
Memory Stop
Fixed Orifice
Location Tag

Material #	Model	Size	Inlet x Outlet Connection	Min/Max Flow Rate GPM	Weight Lbs	List Price
NL2XUL06	T-1810-U	½" ULT	FPT x FPT	0.24/1.0	1.23	\$ 102.00
NL1XM06	T-1810-L	½" L	FPT x FPT	0.52/2.0	1.23	102.00
NL2X006	T-1810	½"	FPT x FPT	1.2/5.0	1.23	102.00
NL2X008	T-1810	¾"	FPT x FPT	2.4/10.0	1.43	105.00
NL2X00A	T-1810	1"	FPT x FPT	4.3/18.0	1.73	119.00
NL2X00B	T-1810	1¼"	FPT x FPT	9.0/33.0	2.78	175.00
NL2X00C	T-1810	1½"	FPT x FPT	13/49.0	3.50	215.00
NL2X00D	T-1810	2"	FPT x FPT	24/78.0	4.82	282.00



FLO-BOSS™ M

DZR Brass Fixed Orifice Balancing Valve

1810 Series – Solder

Ratings

300 PSI Non-Shock Cold Working Pressure
Maximum Temperature 260°F at 150 PSI

Features

Sizes: ½ to 2"
Flow Measurement Accuracy of +/- 3%
Integral Positive Off
Memory Stop
Fixed Orifice
Location Tag

Material #	Model	Size	Inlet x Outlet Connection	Min/Max Flow Rate GPM	Weight Lbs	List Price
NJ2XUL06	S-1810-U	½" ULT	SWT x SWT	0.24/1.0	1.16	\$ 102.00
NJ1XM06	S-1810-L	½" L	SWT x SWT	0.52/2.0	1.16	102.00
NJ2X006	S-1810	½"	SWT x SWT	1.2/5.0	1.16	102.00
NJ2X008	S-1810	¾"	SWT x SWT	2.4/10.0	1.34	105.00
NJ2X00A	S-1810	1"	SWT x SWT	4.3/18.0	1.55	119.00
NJ2X00B	S-1810	1¼"	SWT x SWT	9.0/33.0	2.53	175.00
NJ2X00C	S-1810	1½"	SWT x SWT	13/49.0	3.16	215.00
NJ2X00D	S-1810	2"	SWT x SWT	24/78.0	4.46	282.00



FLO-BOSS™ M

DZR Brass Fixed Orifice Balancing Valve

1810 Series – Threaded x Press

Ratings

200 PSI Non-Shock Cold Working Pressure
Maximum Temperature 250°F at 150 PSI

Features

Sizes: ½ to 2"
Flow Measurement Accuracy of +/- 3%
Integral Positive Off
Memory Stop
Fixed Orifice
Location Tag

Material #	Model	Size	Inlet/Outlet Connection	Min/Max Flow Rate GPM	Weight Lbs	List Price
NMMU2406	TPC1810-U	½" U	FPT x PRESS	0.24/1.0	1.34	\$ 130.00
NMML2406	TPC1810-L	½" L	FPT x PRESS	0.52/2.0	1.34	130.00
NMM2406	TPC1810	½"	FPT x PRESS	1.2/5.0	1.34	130.00
NMM2408	TPC1810	¾"	FPT x PRESS	2.4/10.0	1.63	139.00
NMM240A	TPC1810	1"	FPT x PRESS	4.3/18.0	2.00	169.00
NMM240B	TPC1810	1¼"	FPT x PRESS	9.0/33.0	3.25	235.00
NMM240C	TPC1810	1½"	FPT x PRESS	13/49.0	4.20	303.00
NMM240D	TPC1810	2"	FPT x PRESS	24/78.0	5.75	372.00



FLO-BOSS™ MV

DZR Brass Variable Orifice Balancing Valve

1709 Series – Solder

Ratings

125 PSI Non-Shock Cold Working Pressure
Maximum Temperature 250°F at 125 PSI

Features

Sizes: ½ to 2"
Memory Stop
Variable Orifice

Material #	Model	Size	Inlet x Outlet Connection	Min/Max Flow Rate GPM	Weight Lbs	List Price
NJ1W006	S-1709	½"	SWT x SWT	1.4/4.6	1.1	\$ 114.00
NJ1W008	S-1709	¾"	SWT x SWT	1.4/4.6	1.2	129.00

MANUAL BALANCING VALVES



Ratings

240 PSI Non-Shock Cold Working Pressure
Maximum Temperature 250°F at 240 PSI

Features

Sizes: ½ to 2"
Memory Stop
Variable Orifice

FLO-BOSS™ MV

DZR Brass Variable Orifice Balancing Valve

1710 Series – Threaded

Material #	Model	Size	Inlet x Outlet Connection	Min/Max Flow Rate GPM	Weight Lbs	List Price
NL1XL06	T-1710L	½"L	FPT x FPT	0.47/1.6	1.7	\$ 161.00
NL1X006	T-1710	½"	FPT x FPT	1.5/4.8	1.7	161.00
NL1X008	T-1710	¾"	FPT x FPT	3/8.7	2.0	167.00
NL1X00A	T-1710	1"	FPT x FPT	5.0/14.0	3.1	200.00
NL1X00B	T-1710	1¼"	FPT x FPT	8.0/24.0	4.2	263.00
NL1X00C	T-1710	1½"	FPT x FPT	11.0/32.0	5.1	302.00
NL1X00D	T-1710	2"	FPT x FPT	16/52	8.0	456.00



Ratings

240 PSI Non-Shock Cold Working Pressure
Maximum Temperature 250°F at 240 PSI

Features

Sizes: ½ to 2"
Memory Stop
Variable Orifice

FLO-BOSS™ MV

DZR Brass Variable Orifice Balancing Valve

1710 Series – Solder

Material #	Model	Size	Inlet x Outlet Connection	Min/Max Flow Rate GPM	Weight Lbs	List Price
NJ1XL06	S-1710L	½"L	SWT x SWT	0.47/1.6	1.7	\$ 161.00
NJ1X006	S-1710	½"	SWT x SWT	1.5/4.8	1.7	161.00
NJ1X008	S-1710	¾"	SWT x SWT	3/8.7	2.0	167.00
NJ1X00A	S-1710	1"	SWT x SWT	5.0/14.0	3.1	200.00
NJ1X00B	S-1710	1¼"	SWT x SWT	8.0/24.0	4.2	263.00
NJ1X00C	S-1710	1½"	SWT x SWT	11.0/32.0	5.1	302.00
NJ1X00D	S-1710	2"	SWT x SWT	16/52	8.0	456.00



FLO-BOSS™ MF

Flanged Variable Orifice Balancing Valve

F737A Series – Flanged

Ratings

Flanged ANSI Class 125
240 PSI Non-shock CWP
Maximum Temperature 250°F at 175 PSI

Features

Sizes: 2" to 12"
Cast Iron Body & Bonnet
Globe Valve
Non-Rising Stem
Integral Memory Stop



Material #	Model	Size	Inlet x Outlet Connection	Minimum GPM @ 0.145 PSI	Maximum GPM @ 1.45 PSI	Flow Rate GPM @ 7 ft/s	Weight Lbs	List Price
NHC801D	F737A	2"	Flanged x Flanged	16.8	53.2	73.4	35	\$ 715.00
NHC801E	F737A	2½"	Flanged x Flanged	29.8	94.3	105	51	752.00
NHC801F	F737A	3"	Flanged x Flanged	43.6	138	162	62	973.00
NHC801H	F737A	4"	Flanged x Flanged	78.7	249	278	93	1,376.00
NHC801J	F737A	5"	Flanged x Flanged	105	330	437	152	2,408.00
NHC801K	F737A	6"	Flanged x Flanged	167	529	631	176	3,078.00
NHC801L	F737A	8"	Flanged x Flanged	300	947	1091	362	6,654.00
NHC801M	F737A	10"	Flanged x Flanged	490	1549	1723	590	8,648.00
NHC801N	F737A	12"	Flanged x Flanged	790	2499	2443	838	18,104.00

FLO-BOSS™ MG

Grooved Variable Orifice Balancing Valve

G737A Series – Grooved

Ratings

Grooved Dimensions per ANSI/
AWWA C606 for IPS Pipe
240 PSI Non-shock CWP
Maximum Temperature 250°F at 175 PSI

Features

Sizes: 2½" to 12"
Cast Iron Body & Bonnet
Globe Valve
Non-Rising Stem
Integral Memory Stop

Material #	Model	Size	Inlet x Outlet Connection	Minimum GPM @ 0.145 PSI	Maximum GPM @ 1.45 PSI	Flow Rate GPM @ 7 ft/s	Weight Lbs	List Price
NHC821E	G737A	2½"	Grooved x Grooved	29.8	94.3	105	39	\$ 788.00
NHC821F	G737A	3"	Grooved x Grooved	43.6	138	162	49	1,025.00
NHC821H	G737A	4"	Grooved x Grooved	78.7	249	278	66	1,292.00
NHC821J	G737A	5"	Grooved x Grooved	105	330	437	124	1,903.00
NHC821K	G737A	6"	Grooved x Grooved	167	529	631	148	3,240.00
NHC821L	G737A	8"	Grooved x Grooved	300	947	1091	330	7,004.00
NHC821M	G737A	10"	Grooved x Grooved	490	1549	1723	560	9,102.00
NHC821N	G737A	12"	Grooved x Grooved	790	2499	2443	783	19,056.00

AUTOMATIC BALANCING VALVES

- DEZINCIFICATION-RESISTANT BALANCING VALVES FOR LONG-LASTING, CORROSION-FREE PERFORMANCE
- WIDE RANGE OF FLOW REGULATION CARTRIDGES



AUTOMATIC BALANCING VALVES



Ratings

300 PSI Non-Shock Cold Working Pressure
Maximum Temperature 260°F at 150 PSI

Features

Sizes: ½ to 2"
Flow Measurement Accuracy of +/- 5%
Location Tag
Double Union Ends

FLO-BOSS™ A

DZR Brass Automatic Balancing Valve

1880 Series – Threaded

Material #	Model	Size	Inlet x Outlet Connection	Min/Max Flow Rate GPM	Weight Lbs	List Price
NL2X806	T-1880 Mini	½" Mini	FPT x FPT	0.32/3.17	0.83	\$ 104.00
NL3X806	T-1880	½"	FPT x FPT	2.06/15.1	1.07	104.00
NL2X808	T-1880 Mini	¾" Mini	FPT x FPT	0.32/3.17	0.99	109.00
NL3X808	T-1880	¾"	FPT x FPT	2.06/15.1	1.10	109.00
NL3X80A	T-1880	1"	FPT x FPT	2.06/15.1	1.14	131.00
NL3X80B	T-1880	1¼"	FPT x FPT	4.44/41.2	3.21	249.00
NL3X80C	T-1880	1½"	FPT x FPT	4.44/41.2	3.44	267.00
NL3X80D	T-1880	2"	FPT x FPT	4.44/41.2	7.50	396.00

*Note: Cartridges are not included and must be added separately
See pages 19-20 for cartridge pricing*



Ratings

300 PSI Non-Shock Cold Working Pressure
Maximum Temperature 260°F at 150 PSI

Features

Sizes: ½ to 2"
Flow Measurement Accuracy of +/- 5%
Location Tag
Double Union Ends

FLO-BOSS™ A

DZR Brass Automatic Balancing Valve

1880 Series – Solder

Material #	Model	Size	Inlet x Outlet Connection	Min/Max Flow Rate GPM	Weight Lbs	List Price
NJ2X806	S-1880 Mini	½" Mini	SWT x SWT	0.32/3.17	0.83	\$ 104.00
NJ3X806	S-1880	½"	SWT x SWT	2.06/15.1	1.07	104.00
NJ2X808	S-1880 Mini	¾" Mini	SWT x SWT	0.32/3.17	0.99	109.00
NJ3X808	S-1880	¾"	SWT x SWT	2.06/15.1	1.10	109.00
NJ3X80A	S-1880	1"	SWT x SWT	2.06/15.1	1.14	131.00
NJ3X80B	S-1880	1¼"	SWT x SWT	4.44/41.2	3.21	249.00
NJ3X80C	S-1880	1½"	SWT x SWT	4.44/41.2	3.44	267.00
NJ3X80D	S-1880	2"	SWT x SWT	4.44/41.2	7.50	396.00

*Note: Cartridges are not included and must be added separately
See pages 19-20 for cartridge pricing*



FLO-BOSS™ AI

DZR Brass Automatic Balancing Valve with Isolation

1880 Series – Threaded

Ratings

300 PSI Non-Shock Cold Working Pressure
Maximum Temperature 260°F at 150 PSI

Features

Sizes: ½ to 2"
Flow Measurement Accuracy of +/- 5%
Location Tag

Material #	Model	Size	Inlet x Outlet Connection	Min/Max Flow Rate GPM	Weight Lbs	List Price
NMAMS2206	T-1880SO Mini	½" Mini	FPT x FPT	0.32/3.17	1.29	\$ 127.00
NMAS2206	T-1880SO	½"	FPT x FPT	2.06/15.1	1.53	127.00
NMAMS2208	T-1880SO Mini	¾" Mini	FPT x FPT	0.32/3.17	1.43	138.00
NMAS2208	T-1880SO	¾"	FPT x FPT	2.06/15.1	1.77	138.00
NMAS220A	T-1880SO	1"	FPT x FPT	2.06/15.1	2.24	180.00
NMAS220B	T-1880SO	1¼"	FPT x FPT	4.44/41.2	4.85	317.00
NMAS220C	T-1880SO	1½"	FPT x FPT	4.44/41.2	5.86	386.00
NMAS220D	T-1880SO	2"	FPT x FPT	4.44/41.2	11.04	515.00

*Note: Cartridges are not included and must be added separately
See pages 19-20 for cartridge pricing*



FLO-BOSS™ A

DZR Brass Automatic Balancing Valve

1880 Series – Threaded x Press

Ratings

200 PSI Non-Shock Cold Working Pressure
Maximum Temperature 250°F at 150 PSI

Features

Sizes: ½ to 2"
Flow Measurement Accuracy of +/- 5%
Location Tag

Material #	Model	Size	Inlet x Outlet Connection	Min/Max Flow Rate GPM	Weight Lbs	List Price
NMAM2406	TPC-1880 Mini	½" Mini	FPT x PRESS	0.32/3.17	0.94	\$ 135.00
NMA2406	TPC-1880	½"	FPT x PRESS	2.06/15.1	1.18	135.00
NMAM2408	TPC-1880 Mini	¾" Mini	FPT x PRESS	0.32/3.17	0.96	142.00
NMA2408	TPC-1880	¾"	FPT x PRESS	2.06/15.1	1.3	142.00
NMA240A	TPC-1880	1"	FPT x PRESS	2.06/15.1	1.41	189.00
NMA240B	TPC-1880	1¼"	FPT x PRESS	4.44/41.2	3.68	323.00
NMA240C	TPC1880	1½"	FPT x PRESS	4.44/41.2	4.14	389.00
NMA240D	TPC1880	2"	FPT x PRESS	4.44/41.2	8.43	519.00

*Note: Cartridges are not included and must be added separately
See pages 19-20 for cartridge pricing*

AUTOMATIC BALANCING VALVES



FLO-BOSS™ AI

DZR Brass Automatic Balancing Valve with Isolation

1880 Series – Threaded x Press

Ratings

200 PSI Non-Shock Cold Working Pressure
Maximum Temperature 250°F at 150 PSI

Features

Sizes: ½ to 2"
Flow Measurement Accuracy of +/- 5%
Location Tag

Material #	Model	Size	Inlet x Outlet Connection	Min/Max Flow Rate GPM	Weight Lbs	List Price
NMAMS2406	TPC-1880SO Mini	½" Mini	FPT x PRESS	0.32/3.17	1.40	\$ 159.00
NMAS2406	TPC-1880SO	½"	FPT x PRESS	2.06/15.1	1.64	159.00
NMAMS2408	TPC-1880SO Mini	¾" Mini	FPT x PRESS	0.32/3.17	1.63	169.00
NMAS2408	TPC-1880SO	¾"	FPT x PRESS	2.06/15.1	2.04	169.00
NMAS240A	TPC-1880SO	1"	FPT x PRESS	2.06/15.1	2.51	218.00
NMAS240B	TPC-1880SO	1¼"	FPT x PRESS	4.44/41.2	5.32	359.00
NMAS240C	TPC-1880SO	1½"	FPT x PRESS	4.44/41.2	6.56	449.00
NMAS240D	TPC-1880SO	2"	FPT x PRESS	4.44/41.2	11.97	575.00

Note: Cartridges are not included and must be added separately
See pages 19-20 for cartridge pricing

FLO-BOSS™

1880 Series Automatic Balancing Valve

Automatic Cartridges

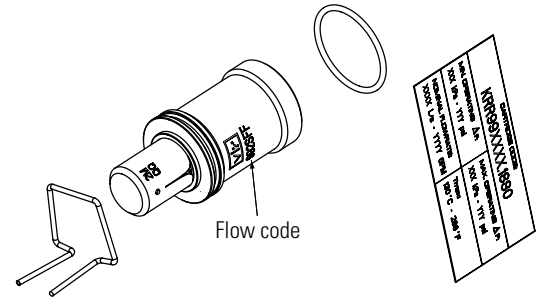

Mini (For 1/2" & 3/4" Mini Valves ONLY)

Standard Range

Material #	Flow (GPM)	List Price
KRR991202	0.32	\$ 69.00
KRR991203	0.48	69.00
KRR991204	0.63	69.00
KRR991205	0.79	69.00
KRR991206	0.95	69.00
KRR991207	1.11	69.00
KRR991208	1.27	69.00
KRR991209	1.43	69.00
KRR991210	1.59	69.00
KRR991211	1.74	69.00
KRR991212	1.90	69.00
KRR991213	2.06	69.00
KRR991214	2.22	69.00
KRR991215	2.38	69.00
KRR991216	2.54	69.00
KRR991218	2.85	69.00
KRR991220	3.17	69.00

Small – For 1/2", 3/4" and 1" Valves

Standard Range

Material #	Flow (GPM)	List Price
KRR992213	2.06	\$ 83.00
KRR992214	2.22	83.00
KRR992215	2.38	83.00
KRR992216	2.54	83.00
KRR992217	2.69	83.00
KRR992219	3.01	83.00
KRR992221	3.33	83.00
KRR992224	3.80	83.00
KRR992226	4.12	83.00
KRR992227	4.28	83.00
KRR992230	4.76	83.00
KRR992233	5.23	83.00
KRR992236	5.71	83.00
KRR992238	6.02	83.00
KRR992240	6.34	83.00
KRR992245	7.13	83.00
KRR992250	7.93	83.00
KRR992255	8.72	83.00
KRR992260	9.51	83.00
KRR992266	10.50	83.00
KRR992272	11.41	83.00

HP Range

Material #	Flow (GPM)	List Price
KRR992318	2.85	\$ 83.00
KRR992320	3.17	83.00
KRR992323	3.65	83.00
KRR992327	3.96	83.00
KRR992329	4.60	83.00
KRR992332	5.07	83.00
KRR992336	5.71	83.00
KRR992340	6.34	83.00
KRR992345	7.13	83.00
KRR992350	7.93	83.00
KRR992355	8.72	83.00
KRR992361	9.67	83.00
KRR992368	10.78	83.00
KRR992375	11.90	83.00
KRR992380	12.68	83.00
KRR992386	13.63	83.00
KRR992395	15.10	83.00

AUTOMATIC BALANCING VALVES

FLO-BOSS™

1880 Series Automatic Balancing Valve

Automatic Cartridges

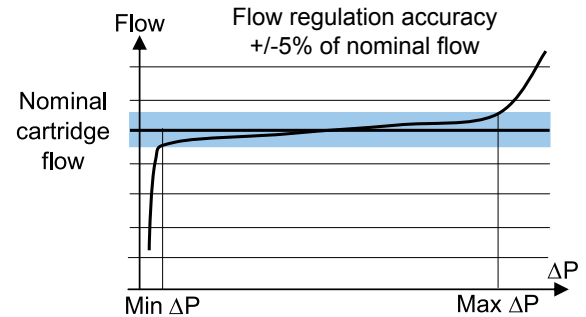

Medium – For 1¼", 1½" and 2" Valves

Standard Range

HP Range

Material #	Flow (GPM)	List Price
KRR994231	4.91	\$ 175.00
KRR994234	5.39	175.00
KRR994237	5.86	175.00
KRR994240	6.34	175.00
KRR994246	7.29	175.00
KRR994250	7.93	175.00
KRR994255	8.72	175.00
KRR994258	9.19	175.00
KRR994262	9.83	175.00
KRR994267	10.6	175.00
KRR994274	11.7	175.00
KRR994283	13.2	175.00
KRR994290	14.3	175.00
KRR994297	15.4	175.00
KRR994210	16.6	175.00
KRR994212	19.0	175.00
KRR994213	20.6	175.00
KRR994214	22.8	175.00
KRR994216	24.7	175.00
KRR994217	26.6	175.00
KRR994218	28.5	175.00
KRR994220	31.1	175.00

Material #	Flow (GPM)	List Price
KRR994341	6.50	\$ 175.00
KRR994346	7.29	175.00
KRR994351	8.08	175.00
KRR994355	8.72	175.00
KRR994362	9.83	175.00
KRR994368	10.80	175.00
KRR994374	11.70	175.00
KRR994379	12.50	175.00
KRR994383	13.20	175.00
KRR994391	14.40	175.00
KRR994310	15.90	175.00
KRR994311	17.60	175.00
KRR994312	19.00	175.00
KRR994313	20.60	175.00
KRR994314	22.00	175.00
KRR994316	26.00	175.00
KRR994318	27.70	175.00
KRR994319	30.10	175.00
KRR994321	32.70	175.00
KRR994322	35.40	175.00
KRR994324	38.00	175.00
KRR994326	41.20	175.00

Sample Label – 1880DU with Cartridge

CARTRIDGE CODE	
KRR992205.1880	
MIN OPERATING Dp: 14 kPa - 2.0 psi	MAX OPERATING Dp: 240 kPa - 35 psi
NOMINAL FLOWRATE: 0.050 L/s - 0.79 GPM	Tmax: 130°C - 266°F

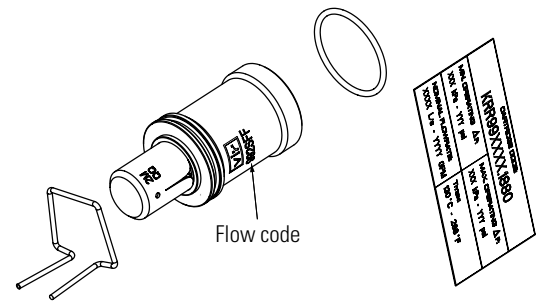

For more detailed flow performance information please contact NIBCO or visit our webpage.

COMBINATION

SHUTOFF VALVES & UNIONS

- FEATURES A SINGLE UNION END DESIGN TO SAVE LABOR, SPACE, AND ADDITIONAL PIPE JOINTS
- DEZINCIFICATION RESISTANT WITH DRILLED AND TAPPED BOSSES



COMBINATION STRAINER VALVES



Ratings

400 PSI Non-Shock Cold Working Pressure to 175°F
Maximum Temperature 260°F at 150 PSI

Features

Sizes: ½ to 2"
20 Mesh 304 Stainless Steel Filter
Integral Positive Off

FLO-BOSS™ S

DZR Brass Combination Ball Valve with Union, Integral Strainer, Test Point and Drain Valve

1820 Series – Threaded

Material #	Model	Size	Inlet x Outlet Connection	Weight Lbs	List Price
NL3X206	T-1820	½"	FPT x FPT	1.15	\$ 76.00
NL3X208	T-1820	¾"	FPT x FPT	1.37	84.00
NL3X20A	T-1820	1"	FPT x FPT	1.78	112.00
NL3X20B	T-1820	1¼"	FPT x FPT	2.69	144.00
NL3X20C	T-1820	1½"	FPT x FPT	3.43	212.00
NL3X20D	T-1820	2"	FPT x FPT	5.40	267.00



Ratings

400 PSI Non-Shock Cold Working Pressure to 175°F
Maximum Temperature 260°F at 150 PSI

Features

Sizes: ½ to 2"
20 Mesh 304 Stainless Steel Filter
Integral Positive Off

FLO-BOSS™ S

DZR Brass Combination Ball Valve with Union, Integral Strainer, Test Point and Drain Valve

1820 Series – Solder

Material #	Model	Size	Inlet x Outlet Connection	Weight Lbs	List Price
NJ3X206	S-1820	½"	SWT x SWT	1.09	\$ 76.00
NJ3X208	S-1820	¾"	SWT x SWT	1.30	84.00
NJ3X20A	S-1820	1"	SWT x SWT	1.74	112.00
NJ3X20B	S-1820	1¼"	SWT x SWT	2.72	144.00
NJ3X20C	S-1820	1½"	SWT x SWT	3.44	212.00
NJ3X20D	S-1820	2"	SWT x SWT	5.59	267.00



FLO-BOSS™ S

DZR Brass Combination Ball Valve with Union,
Integral Strainer, Test Point and Drain Valve

1820 Series – Press x Threaded

Ratings

200 PSI Non-Shock Cold Working Pressure
Maximum Temperature 250°F at 200 PSI

Features

Sizes: ½ to 2"
20 Mesh 304 Stainless Steel Filter
Integral Positive Off

Material #	Model	Size	Inlet x Outlet Connection	Weight Lbs	List Price
NMP3X206	PCT-1820	½"	PRESS x FPT	1.20	\$ 85.00
NMP3X208	PCT-1820	¾"	PRESS x FPT	1.50	93.00
NMP3X20A	PCT-1820	1"	PRESS x FPT	2.01	121.00
NMP3X20B	PCT-1820	1¼"	PRESS x FPT	3.19	153.00
NMP3X20C	PCT-1820	1½"	PRESS x FPT	4.14	227.00
NMP3X20D	PCT-1820	2"	PRESS x FPT	6.52	282.00

COMBINATION ISOLATION VALVES



Ratings

600 PSI Non-Shock Cold Working Pressure
Maximum Temperature 250°F at 200 PSI

Features

Sizes: ½ to 2"
Integral Positive Off

FLO-BOSS™ I

DZR Brass Combination Isolation Ball Valve with Union, Test Point and Drain Valve

1830 Series – Threaded

Material #	Model	Size	Inlet x Outlet Connection	Weight Lbs	List Price
NL3X306	T-1830	½"	FPT x FPT	0.97	\$ 69.00
NL3X308	T-1830	¾"	FPT x FPT	1.13	76.00
NL3X30A	T-1830	1"	FPT x FPT	1.48	107.00
NL3X30B	T-1830	1¼"	FPT x FPT	2.21	127.00
NL3X30C	T-1830	1½"	FPT x FPT	2.80	184.00
NL3X30D	T-1830	2"	FPT x FPT	4.33	220.00



Ratings

600 PSI Non-Shock Cold Working Pressure
Maximum Temperature 250°F at 200 PSI
ANSI B16.22

Features

Sizes: ½ to 2"
Integral Positive Off

FLO-BOSS™ I

DZR Brass Combination Isolation Ball Valve with Union, Test Point and Drain Valve

1830 Series – Solder

Material #	Model	Size	Inlet x Outlet Connection	Weight Lbs	List Price
NJ3X306	S-1830	½"	SWT x SWT	0.9	\$ 69.00
NJ3X308	S-1830	¾"	SWT x SWT	1.09	76.00
NJ3X30A	S-1830	1"	SWT x SWT	1.47	107.00
NJ3X30B	S-1830	1¼"	SWT x SWT	2.13	127.00
NJ3X30C	S-1830	1½"	SWT x SWT	2.82	184.00
NJ3X30D	S-1830	2"	SWT x SWT	4.54	220.00



FLO-BOSS™ I

DZR Brass Combination Isolation Ball Valve with Union, Test Point and Drain Valve

1830 Series – Press x Threaded

Ratings

200 PSI Non-Shock Cold Working Pressure
Maximum Temperature 250°F at 200 PSI

Features

Sizes: ½ to 2"
Integral Positive Off

Material #	Model	Size	Inlet x Outlet Connection	Weight Lbs	List Price
NMP3X306	PCT-1830	½"	PRESS x FPT	1.08	\$ 78.00
NMP3X308	PCT-1830	¾"	PRESS x FPT	1.33	85.00
NMP3X30A	PCT-1830	1"	PRESS x FPT	1.65	116.00
NMP3X30B	PCT-1830	1¼"	PRESS x FPT	2.68	136.00
NMP3X30C	PCT-1830	1½"	PRESS x FPT	3.50	199.00
NMP3X30D	PCT-1830	2"	PRESS x FPT	5.26	235.00



FLO-BOSS™ U

DZR Brass Union with Test Port

1800 Series – SWT x SWT

Ratings

600 PSI Non-Shock Cold Working Pressure at 100°F
Maximum Temperature 250°F at 200 PSI

Features

Sizes: ½ to 2"

Material #	Model	Size	Inlet x Outlet Connection	Weight Lbs	List Price
NJ3X406	S-1800	½"	SWT x SWT	0.49	\$ 49.00
NJ3X408	S-1800	¾"	SWT x SWT	0.60	52.00
NJ3X40A	S-1800	1"	SWT x SWT	0.79	68.00
NJ3X40B	S-1800	1¼"	SWT x SWT	1.11	89.00
NJ3X40C	S-1800	1½"	SWT x SWT	1.41	97.00
NJ3X40D	S-1800	2"	SWT x SWT	2.01	144.00
NMU11R86	S-1800R	¾" x ½"	SWT x SWT	0.58	44.00
NMU11RA6	S-1800R	1" x ½"	SWT x SWT	0.76	52.00
NMU11RA8	S-1800R	1" x ¾"	SWT x SWT	0.76	52.00
NMU11RB8	S-1800R	1¼" x ¾"	SWT x SWT	1.10	72.00
NMU11RBA	S-1800R	1¼" x 1"	SWT x SWT	1.10	72.00
NMU11RCA	S-1800R	1½" x 1"	SWT x SWT	1.42	87.00
NMU11RCB	S-1800R	1½" x 1¼"	SWT x SWT	1.41	87.00
NMU11RDB	S-1800R	2" x 1¼"	SWT x SWT	2.06	110.00
NMU11RDC	S-1800R	2" x 1½"	SWT x SWT	2.03	110.00



FLO-BOSS™ U

DZR Brass Union with Test Port

1800 Series – SWT x FPT

Ratings

600 PSI Non-Shock Cold Working Pressure at 100°F
Maximum Temperature 250°F at 200 PSI

Features

Sizes: ½ to 2"

Material #	Model	Size	Inlet x Outlet Connection	Weight Lbs	List Price
NMU1206	ST-1800	½"	SWT x FPT	0.48	\$ 40.00
NMU1208	ST-1800	¾"	SWT x FPT	0.58	44.00
NMU120A	ST-1800	1"	SWT x FPT	0.76	52.00
NMU120B	ST-1800	1¼"	SWT x FPT	1.07	72.00
NMU120C	ST-1800	1½"	SWT x FPT	1.37	87.00
NMU120D	ST-1800	2"	SWT x FPT	1.88	110.00
NMU12R86	ST-1800R	¾" x ½"	SWT x FPT	0.592	44.00
NMU12RA6	ST-1800R	1" x ½"	SWT x FPT	0.78	52.00
NMU12RA8	ST-1800R	1" x ¾"	SWT x FPT	0.77	52.00
NMU12RB8	ST-1800R	1¼" x ¾"	SWT x FPT	1.10	72.00
NMU12RBA	ST-1800R	1¼" x 1"	SWT x FPT	1.10	72.00
NMU12RCA	ST-1800R	1½" x 1"	SWT x FPT	1.43	87.00
NMU12RCB	ST-1800R	1½" x 1¼"	SWT x FPT	1.40	87.00
NMU12RDB	ST-1800R	2" x 1¼"	SWT x FPT	2.03	110.00
NMU12RDC	ST-1800R	2" x 1½"	SWT x FPT	2.00	110.00



FLO-BOSS™ U

DZR Brass Union with Test Port

1800 Series – SWT x MPT

Ratings

600 PSI Non-Shock Cold Working Pressure at 100°F
Maximum Temperature 250°F at 200 PSI

Features

Sizes: ½ to 2"

Material #	Model	Size	Inlet x Outlet Connection	Weight Lbs	List Price
NMU1306	SMT-1800	½"	SWT x MPT	0.50	\$ 40.00
NMU1308	SMT-1800	¾"	SWT x MPT	0.62	44.00
NMU130A	SMT-1800	1"	SWT x MPT	0.85	52.00
NMU130B	SMT-1800	1¼"	SWT x MPT	1.22	72.00
NMU130C	SMT-1800	1½"	SWT x MPT	1.52	87.00
NMU130D	SMT-1800	2"	SWT x MPT	2.19	110.00
NMU13R86	SMT-1800R	¾" x ½"	SWT x MPT	0.60	44.00
NMU13RA6	SMT-1800R	1" x ½"	SWT x MPT	0.75	52.00
NMU13RA8	SMT-1800R	1" x ¾"	SWT x MPT	0.79	52.00
NMU13RB8	SMT-1800R	1¼" x ¾"	SWT x MPT	1.08	72.00
NMU13RBA	SMT-1800R	1¼" x 1"	SWT x MPT	1.15	72.00
NMU13RCA	SMT-1800R	1½" x 1"	SWT x MPT	1.45	87.00
NMU13RCB	SMT-1800R	1½" x 1¼"	SWT x MPT	1.51	87.00
NMU13RDB	SMT-1800R	2" x 1¼"	SWT x MPT	2.08	110.00
NMU13RDC	SMT-1800R	2" x 1½"	SWT x MPT	2.07	110.00



FLO-BOSS™ U

DZR Brass Union with Test Port

1800 Series – SWT x Press

Ratings

200 PSI Non-Shock Cold Working Pressure
Maximum Temperature 250°F at 200 PSI

Features

Sizes: ½ to 2"

Material #	Model	Size	Inlet x Outlet Connection	Weight Lbs	List Price
NMU1406	SPC-1800	½"	SWT x PRESS	0.59	\$ 63.00
NMU1408	SPC-1800	¾"	SWT x PRESS	0.78	66.00
NMU140A	SPC-1800	1"	SWT x PRESS	1.03	78.00
NMU140B	SPC-1800	1-¼"	SWT x PRESS	1.54	95.00
NMU140C	SPC-1800	1½"	SWT x PRESS	2.07	117.00
NMU140D	SPC-1800	2"	SWT x PRESS	2.81	182.00
NMU14R86	SPC-1800R	¾" x ½"	SWT x PRESS	0.70	66.00
NMU14RA6	SPC-1800R	1" x ½"	SWT x PRESS	0.89	79.00
NMU14RA8	SPC-1800R	1" x ¾"	SWT x PRESS	1.04	78.00
NMU14RB8	SPC-1800R	1¼" x ¾"	SWT x PRESS	1.30	96.00
NMU14RBA	SPC-1800R	1¼" x 1"	SWT x PRESS	1.37	96.00
NMU14RCA	SPC-1800R	1½" x 1"	SWT x PRESS	1.70	119.00
NMU14RCB	SPC-1800R	1½" x 1¼"	SWT x PRESS	1.87	118.00
NMU14RDB	SPC-1800R	2" x 1¼"	SWT x PRESS	2.50	187.00
NMU14RDC	SPC-1800R	2" x 1½"	SWT x PRESS	2.70	186.00



FLO-BOSS™ U

DZR Brass Union with Test Port

1800 Series – FPT x SWT

Ratings

600 PSI Non-Shock Cold Working Pressure at 100°F
Maximum Temperature 250°F at 200 PSI

Features

Sizes: ½ to 2"

Material #	Model	Size	Inlet x Outlet Connection	Weight Lbs	List Price
NMU2106	TS-1800	½"	FPT x SWT	0.50	\$ 40.00
NMU2108	TS-1800	¾"	FPT x SWT	0.62	44.00
NMU210A	TS-1800	1"	FPT x SWT	0.79	52.00
NMU210B	TS-1800	1¼"	FPT x SWT	1.15	72.00
NMU210C	TS-1800	1½"	FPT x SWT	1.45	87.00
NMU210D	TS-1800	2"	FPT x SWT	2.00	110.00
NMU21R86	TS-1800R	¾" x ½"	FPT x SWT	0.642	44.00
NMU21RA6	TS-1800R	1" x ½"	FPT x SWT	0.81	52.00
NMU21RA8	TS-1800R	1" x ¾"	FPT x SWT	0.80	52.00
NMU21RB8	TS-1800R	1¼" x ¾"	FPT x SWT	1.18	72.00
NMU21RBA	TS-1800R	1¼" x 1"	FPT x SWT	1.18	72.00
NMU21RCA	TS-1800R	1½" x 1"	FPT x SWT	1.48	87.00
NMU21RCB	TS-1800R	1½" x 1¼"	FPT x SWT	1.47	87.00
NMU21RDB	TS-1800R	2" x 1¼"	FPT x SWT	2.06	110.00
NMU21RDC	TS-1800R	2" x 1½"	FPT x SWT	2.03	110.00



FLO-BOSS™ U

DZR Brass Union with Test Port

1800 Series – FPT x FPT

Ratings

600 PSI Non-Shock Cold Working Pressure at 100°F
Maximum Temperature 250°F at 200 PSI

Features

Sizes: ½ to 2"

Material #	Model	Size	Inlet x Outlet Connection	Weight Lbs	List Price
NL3X406	T-1800	½"	FPT x FPT	0.55	\$ 49.00
NL3X408	T-1800	¾"	FPT x FPT	0.67	52.00
NL3X40A	T-1800	1"	FPT x FPT	0.83	68.00
NL3X40B	T-1800	1¼"	FPT x FPT	1.17	89.00
NL3X40C	T-1800	1½"	FPT x FPT	1.44	97.00
NL3X40D	T-1800	2"	FPT x FPT	1.89	144.00
NMU22R86	T-1800R	¾" x ½"	FPT x FPT	0.642	44.00
NMU22RA6	T-1800R	1" x ½"	FPT x FPT	0.81	52.00
NMU22RA8	T-1800R	1" x ¾"	FPT x FPT	0.80	52.00
NMU22RB8	T-1800R	1¼" x ¾"	FPT x FPT	1.18	72.00
NMU22RBA	T-1800R	1¼" x 1"	FPT x FPT	1.18	72.00
NMU22RCA	T-1800R	1½" x 1"	FPT x FPT	1.49	87.00
NMU22RCB	T-1800R	1½" x 1¼"	FPT x FPT	1.46	87.00
NMU22RDB	T-1800R	2" x 1¼"	FPT x FPT	2.03	110.00
NMU22RDC	T-1800R	2" x 1½"	FPT x FPT	2.00	110.00



FLO-BOSS™ U

DZR Brass Union with Test Port

1800 Series – FPT x MPT

Ratings

600 PSI Non-Shock Cold Working Pressure at 100°F
Maximum Temperature 250°F at 200 PSI

Features

Sizes: ½ to 2"

Material #	Model	Size	Inlet x Outlet Connection	Weight Lbs	List Price
NMU2306	TMT-1800	½"	FPT x MPT	0.54	\$ 40.00
NMU2308	TMT-1800	¾"	FPT x MPT	0.65	44.00
NMU230A	TMT-1800	1"	FPT x MPT	0.88	52.00
NMU230B	TMT-1800	1¼"	FPT x MPT	1.51	72.00
NMU230C	TMT-1800	1½"	FPT x MPT	1.58	87.00
NMU230D	TMT-1800	2"	FPT x MPT	2.19	110.00
NMU23R86	TMT-1800R	¾" x ½"	FPT x MPT	0.65	44.00
NMU23RA6	TMT-1800R	1" x ½"	FPT x MPT	0.78	52.00
NMU23RA8	TMT-1800R	1" x ¾"	FPT x MPT	0.82	52.00
NMU23RB8	TMT-1800R	1¼" x ¾"	FPT x MPT	1.06	72.00
NMU23RBA	TMT-1800R	1¼" x 1"	FPT x MPT	1.23	72.00
NMU23RCA	TMT-1800R	1½" x 1"	FPT x MPT	1.51	87.00
NMU23RCB	TMT-1800R	1½" x 1¼"	FPT x MPT	1.57	87.00
NMU23RDB	TMT-1800R	2" x 1¼"	FPT x MPT	2.08	110.00
NMU23RDC	TMT-1800R	2" x 1½"	FPT x MPT	2.07	110.00

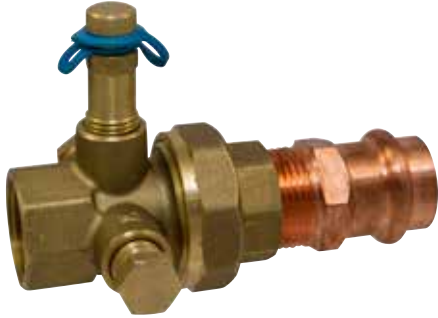

FLO-BOSS™ U

DZR Brass Union with Test Port

1800 Series – FPT x Press

Ratings

200 PSI Non-Shock Cold Working Pressure to 250°F
Maximum Temperature 250°F at 200 PSI

Features

Sizes: ½ to 2"

Material #	Model	Size	Inlet x Outlet Connection	Weight Lbs	List Price
NMU2406	TPC-1800	½"	FPT x PRESS	0.66	\$ 65.00
NMU2408	TPC-1800	¾"	FPT x PRESS	0.87	69.00
NMU240A	TPC-1800	1"	FPT x PRESS	1.10	83.00
NMU240B	TPC-1800	1¼"	FPT x PRESS	1.64	105.00
NMU240C	TPC-1800	1½"	FPT x PRESS	2.14	126.00
NMU240D	TPC-1800	2"	FPT x PRESS	2.82	193.00
NMU24R86	TPC-1800R	¾" x ½"	FPT x PRESS	0.75	68.00
NMU24RA6	TPC-1800R	1" x ½"	FPT x PRESS	0.92	80.00
NMU24RA8	TPC-1800R	1" x ¾"	FPT x PRESS	1.00	80.00
NMU24RB8	TPC-1800R	1¼" x ¾"	FPT x PRESS	1.38	98.00
NMU24RBA	TPC-1800R	1¼" x 1"	FPT x PRESS	1.45	98.00
NMU24RCA	TPC-1800R	1½" x 1"	FPT x PRESS	1.76	121.00
NMU24RCB	TPC-1800R	1½" x 1¼"	FPT x PRESS	1.93	120.00
NMU24RDB	TPC-1800R	2" x 1¼"	FPT x PRESS	2.50	186.00
NMU24RDC	TPC-1800R	2" x 1½"	FPT x PRESS	2.70	185.00



FLO-BOSS™ U

DZR Brass Union with Test Port

1800 Series – MPT x MPT

Ratings

600 PSI Non-Shock Cold Working Pressure to 100°F
Maximum Temperature 250°F at 200 PSI

Features

Sizes: ½ to 2"

Material #	Model	Size	Inlet x Outlet Connection	Weight Lbs	List Price
NMU3306	MT-1800	½"	MPT x MPT	0.54	\$ 40.00
NMU3308	MT-1800	¾"	MPT x MPT	0.67	44.00
NMU330A	MT-1800	1"	MPT x MPT	0.94	52.00
NMU330B	MT-1800	1¼"	MPT x MPT	1.38	72.00
NMU330C	MT-1800	1½"	MPT x MPT	1.66	87.00
NMU330D	MT-1800	2"	MPT x MPT	2.37	110.00
NMU33R86	MT-1800R	¾" x ½"	MPT x MPT	0.65	44.00
NMU33RA6	MT-1800R	1" x ½"	MPT x MPT	0.84	52.00
NMU33RA8	MT-1800R	1" x ¾"	MPT x MPT	0.88	52.00
NMU33RB8	MT-1800R	1¼" x ¾"	MPT x MPT	1.24	72.00
NMU33RBA	MT-1800R	1¼" x 1"	MPT x MPT	1.31	72.00
NMU33RCA	MT-1800R	1½" x 1"	MPT x MPT	1.59	87.00
NMU33RCB	MT-1800R	1½" x 1¼"	MPT x MPT	1.65	87.00
NMU33RDB	MT-1800R	2" x 1¼"	MPT x MPT	2.26	110.00
NMU33RDC	MT-1800R	2" x 1½"	MPT x MPT	2.25	110.00



FLO-BOSS™ U

DZR Brass Union with Test Port

1800 Series – MPT x SWT

Ratings

600 PSI Non-Shock Cold Working Pressure to 100°F
Maximum Temperature 250°F at 200 PSI

Features

Sizes: ½ to 2"

Material #	Model	Size	Inlet x Outlet Connection	Weight Lbs	List Price
NMU3106	MTS-1800	½"	MPT x SWT	0.50	\$ 40.00
NMU3108	MTS-1800	¾"	MPT x SWT	0.62	44.00
NMU310A	MTS-1800	1"	MPT x SWT	0.85	52.00
NMU310B	MTS-1800	1¼"	MPT x SWT	1.23	72.00
NMU310C	MTS-1800	1½"	MPT x SWT	1.66	87.00
NMU310D	MTS-1800	2"	MPT x SWT	2.37	110.00
NMU31R86	MTS-1800R	¾" x ½"	MPT x SWT	0.63	44.00
NMU31RA6	MTS-1800R	1" x ½"	MPT x SWT	0.85	52.00
NMU31RA8	MTS-1800R	1" x ¾"	MPT x SWT	0.85	52.00
NMU31RB8	MTS-1800R	1¼" x ¾"	MPT x SWT	1.26	72.00
NMU31RBA	MTS-1800R	1¼" x 1"	MPT x SWT	1.26	72.00
NMU31RCA	MTS-1800R	1½" x 1"	MPT x SWT	1.56	87.00
NMU31RCB	MTS-1800R	1½" x 1¼"	MPT x SWT	1.55	87.00
NMU31RDB	MTS-1800R	2" x 1¼"	MPT x SWT	2.26	110.00
NMU31RDC	MTS-1800R	2" x 1½"	MPT x SWT	2.25	110.00



FLO-BOSS™ U

DZR Brass Union with Test Port

1800 Series – MPT x FPT

Ratings

600 PSI Non-Shock Cold Working Pressure to 100°F
Maximum Temperature 250°F at 200 PSI

Features

Sizes: ½ to 2"

Material #	Model	Size	Inlet x Outlet Connection	Weight Lbs	List Price
NMU3206	MTT-1800	½"	MPT x FPT	0.52	\$ 65.00
NMU3208	MTT-1800	¾"	MPT x FPT	0.63	69.00
NMU320A	MTT-1800	1"	MPT x FPT	0.85	83.00
NMU320B	MTT-1800	1¼"	MPT x FPT	1.23	105.00
NMU320C	MTT-1800	1½"	MPT x FPT	1.51	126.00
NMU320D	MTT-1800	2"	MPT x FPT	2.06	193.00
NMU32R86	MTT-1800R	¾" x ½"	MPT x FPT	0.64	68.00
NMU32RA6	MTT-1800R	1" x ½"	MPT x FPT	0.87	80.00
NMU32RA8	MTT-1800R	1" x ¾"	MPT x FPT	0.86	80.00
NMU32RB8	MTT-1800R	1¼" x ¾"	MPT x FPT	1.26	98.00
NMU32RBA	MTT-1800R	1¼" x 1"	MPT x FPT	1.36	98.00
NMU32RCA	MTT-1800R	1½" x 1"	MPT x FPT	1.57	121.00
NMU32RCB	MTT-1800R	1½" x 1¼"	MPT x FPT	1.54	120.00
NMU32RDB	MTT-1800R	2" x 1¼"	MPT x FPT	2.21	186.00
NMU32RDC	MTT-1800R	2" x 1½"	MPT x FPT	2.18	185.00



FLO-BOSS™ U

DZR Brass Union with Test Port

1800 Series – MPT x Press

Ratings

200 PSI Non-Shock Cold Working Pressure to 250°F
Maximum Temperature 250°F at 200 PSI

Features

Sizes: ½ to 2"

Material #	Model	Size	Inlet x Outlet Connection	Weight Lbs	List Price
NMU3406	MTPC-1800	½"	MPT x PRESS	0.63	\$ 64.00
NMU3408	MTPC-1800	¾"	MPT x PRESS	0.83	68.00
NMU340A	MTPC-1800	1"	MPT x PRESS	1.12	81.00
NMU340B	MTPC-1800	1¼"	MPT x PRESS	1.70	101.00
NMU340C	MTPC-1800	1½"	MPT x PRESS	2.21	122.00
NMU340D	MTPC-1800	2"	MPT x PRESS	2.99	181.00
NMU34R86	MTPC-1800R	¾" x ½"	MPT x PRESS	0.75	68.00
NMU34RA6	MTPC-1800R	1" x ½"	MPT x PRESS	0.98	81.00
NMU34RA8	MTPC-1800R	1" x ¾"	MPT x PRESS	1.07	81.00
NMU34RB8	MTPC-1800R	1¼" x ¾"	MPT x PRESS	1.63	102.00
NMU34RBA	MTPC-1800R	1¼" x 1"	MPT x PRESS	1.93	102.00
NMU34RCA	MTPC-1800R	1½" x 1"	MPT x PRESS	1.84	124.00
NMU34RCB	MTPC-1800R	1½" x 1¼"	MPT x PRESS	2.01	123.00
NMU34RDB	MTPC-1800R	2" x 1¼"	MPT x PRESS	2.68	187.00
NMU34RDC	MTPC-1800R	2" x 1½"	MPT x PRESS	2.88	185.00



FLO-BOSS™ U

DZR Brass Union with Test Port

1800 Series – Press x SWT

Ratings

200 PSI Non-Shock Cold Working Pressure to 250°F
Maximum Temperature 250°F at 200 PSI

Features

Sizes: ½ to 2"

Material #	Model	Size	Inlet x Outlet Connection	Weight Lbs	List Price
NMU4106	PCS-1800	½"	PRESS x SWT	0.61	\$ 63.00
NMU4108	PCS-1800	¾"	PRESS x SWT	0.82	67.00
NMU410A	PCS-1800	1"	PRESS x SWT	1.06	79.00
NMU410B	PCS-1800	1¼"	PRESS x SWT	1.62	99.00
NMU410C	PCS-1800	1½"	PRESS x SWT	2.15	121.00
NMU410D	PCS-1800	2"	PRESS x SWT	2.93	186.00
NMU41R86	PCS-1800R	¾" x ½"	PRESS x SWT	0.84	67.00
NMU41RA6	PCS-1800R	1" x ½"	PRESS x SWT	1.08	79.00
NMU41RA8	PCS-1800R	1" x ¾"	PRESS x SWT	1.07	79.00
NMU41RB8	PCS-1800R	1¼" x ¾"	PRESS x SWT	1.65	100.00
NMU41RBA	PCS-1800R	1¼" x 1"	PRESS x SWT	1.65	101.00
NMU41RCA	PCS-1800R	1½" x 1"	PRESS x SWT	2.18	121.00
NMU41RCB	PCS-1800R	1½" x 1¼"	PRESS x SWT	2.17	122.00
NMU41RDB	PCS-1800R	2" x 1¼"	PRESS x SWT	2.99	188.00
NMU41RDC	PCS-1800R	2" x 1½"	PRESS x SWT	2.96	187.00



FLO-BOSS™ U

DZR Brass Union with Test Port

1800 Series – Press x FPT

Ratings

200 PSI Non-Shock Cold Working Pressure to 250°F
Maximum Temperature 250°F at 200 PSI

Features

Sizes: ½ to 2"

Material #	Model	Size	Inlet x Outlet Connection	Weight Lbs	List Price
NMU4206	PCT-1800	½"	PRESS x FPT	0.66	\$ 64.00
NMU4208	PCT-1800	¾"	PRESS x FPT	0.87	68.00
NMU420A	PCT-1800	1"	PRESS x FPT	1.10	81.00
NMU420B	PCT-1800	1¼"	PRESS x FPT	1.64	101.00
NMU420C	PCT-1800	1½"	PRESS x FPT	2.14	122.00
NMU420D	PCT-1800	2"	PRESS x FPT	2.82	181.00
NMU42R86	PCT-1800R	¾" x ½"	PRESS x FPT	0.85	68.00
NMU42RA6	PCT-1800R	1" x ½"	PRESS x FPT	1.08	79.00
NMU42RA8	PCT-1800R	1" x ¾"	PRESS x FPT	1.07	79.00
NMU42RB8	PCT-1800R	1¼" x ¾"	PRESS x FPT	1.65	98.00
NMU42RBA	PCT-1800R	1¼" x 1"	PRESS x FPT	1.65	98.00
NMU42RCA	PCT-1800R	1½" x 1"	PRESS x FPT	2.19	121.00
NMU42RCB	PCT-1800R	1½" x 1¼"	PRESS x FPT	2.16	120.00
NMU42RDB	PCT-1800R	2" x 1¼"	PRESS x FPT	2.96	186.00
NMU42RDC	PCT-1800R	2" x 1½"	PRESS x FPT	2.93	185.00



FLO-BOSS™ U

DZR Brass Union with Test Port

1800 Series – Press x MPT

Ratings

200 PSI Non-Shock Cold Working Pressure to 250°F
Maximum Temperature 250°F at 200 PSI

Features

Sizes: ½ to 2"

Material #	Model	Size	Inlet x Outlet Connection	Weight Lbs	List Price
NMU4306	PCMT-1800	½"	PRESS x MPT	0.63	\$ 65.00
NMU4308	PCMT-1800	¾"	PRESS x MPT	0.83	69.00
NMU430A	PCMT-1800	1"	PRESS x MPT	1.12	83.00
NMU430B	PCMT-1800	1¼"	PRESS x MPT	1.70	105.00
NMU430C	PCMT-1800	1½"	PRESS x MPT	2.21	126.00
NMU430D	PCMT-1800	2"	PRESS x MPT	2.19	193.00
NMU43R86	PCMT-1800R	¾" x ½"	PRESS x MPT	0.76	69.00
NMU43RA6	PCMT-1800R	1" x ½"	PRESS x MPT	1.05	80.00
NMU43RA8	PCMT-1800R	1" x ¾"	PRESS x MPT	1.09	80.00
NMU43RB8	PCMT-1800R	1¼" x ¾"	PRESS x MPT	1.53	102.00
NMU43RBA	PCMT-1800R	1¼" x 1"	PRESS x MPT	1.60	102.00
NMU43RCA	PCMT-1800R	1½" x 1"	PRESS x MPT	2.21	124.00
NMU43RCB	PCMT-1800R	1½" x 1¼"	PRESS x MPT	2.27	125.00
NMU43RDB	PCMT-1800R	2" x 1¼"	PRESS x MPT	3.01	188.00
NMU43RDC	PCMT-1800R	2" x 1½"	PRESS x MPT	3.00	187.00



FLO-BOSS™ U

DZR Brass Union with Test Port

1800 Series – Press x Press

Ratings

200 PSI Non-Shock Cold Working Pressure to 250°F
Maximum Temperature 250°F at 200 PSI

Features

Sizes: ½ to 2"

Material #	Model	Size	Inlet x Outlet Connection	Weight Lbs	List Price
NMU4406	PC-1800	½"	PRESS x PRESS	0.77	\$ 81.00
NMU4408	PC-1800	¾"	PRESS x PRESS	1.07	86.00
NMU440A	PC-1800	1"	PRESS x PRESS	1.37	107.00
NMU440B	PC-1800	1¼"	PRESS x PRESS	2.01	127.00
NMU440C	PC-1800	1½"	PRESS x PRESS	2.84	160.00
NMU440D	PC-1800	2"	PRESS x PRESS	3.75	263.00
NMU44R86	PC-1800R	¾" x ½"	PRESS x PRESS	0.96	84.00
NMU44RA6	PC-1800R	1" x ½"	PRESS x PRESS	1.19	101.00
NMU44RA8	PC-1800R	1" x ¾"	PRESS x PRESS	1.27	101.00
NMU44RB8	PC-1800R	1¼" x ¾"	PRESS x PRESS	1.85	124.00
NMU44RBA	PC-1800R	1¼" x 1"	PRESS x PRESS	1.92	124.00
NMU44RCA	PC-1800R	1½" x 1"	PRESS x PRESS	2.46	155.00
NMU44RCB	PC-1800R	1½" x 1¼"	PRESS x PRESS	2.63	155.00
NMU44RDB	PC-1800R	2" x 1¼"	PRESS x PRESS	3.43	269.00
NMU44RDC	PC-1800R	2" x 1½"	PRESS x PRESS	3.63	267.00

COIL-CONNECT®

PREPACKAGED COIL KITS

— MANUAL AND AUTOMATIC VALVE KITS

— INDIVIDUALLY PACKAGED AND
LABELED PER REQUIREMENTS



COIL-CONNECT® PREPACKAGED COIL KITS



FLO-BOSS™

Manual Coil-Connect® Kit with Isolation Valve

NCC1T – Threaded

Includes

- T-1810 (1) Manual Balancing Valve
- T-1830 (1) Combination Isolation Valve
- T-1800 (1) Union

Features

Sizes: ½ to 2"

Material #	Model	Size	Min/Max Flow Rate GPM	Weight Lbs	List Price
NCC1T006	NCC1T	½"	1.2/5.0	2.75	\$ 217.00
NCC1T008	NCC1T	¾"	2.4/10.0	3.23	233.00
NCC1T00A	NCC1T	1"	4.3/18.0	4.04	299.00
NCC1T00B	NCC1T	1¼"	9.0/33.0	6.16	396.00
NCC1T00C	NCC1T	1½"	13/49.0	7.74	501.00
NCC1T00D	NCC1T	2"	24/78.0	11.04	651.00

Note: Flexible hoses are not included and must be added separately

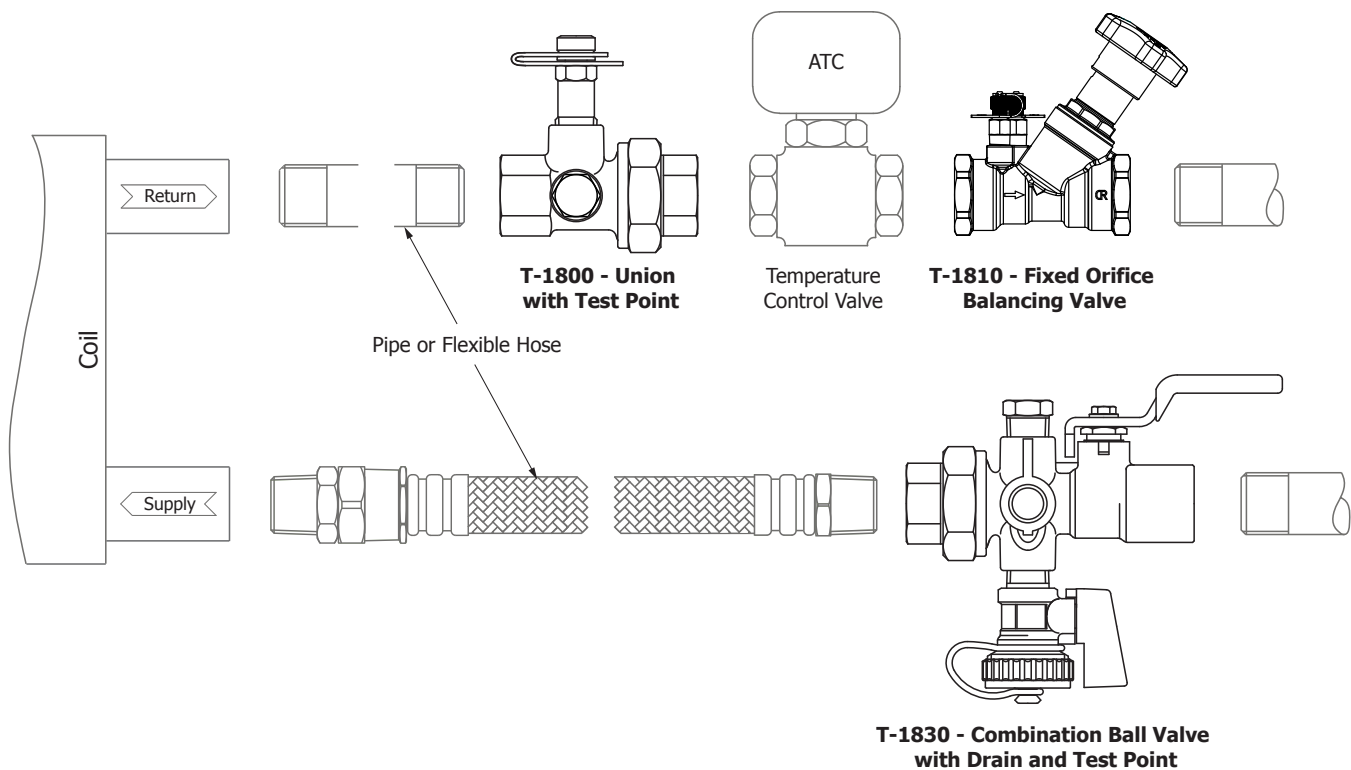



FLO-BOSS™

Manual Coil-Connect® Kit with Isolation Valve NCC1S – Solder

Includes

- S-1810 (1) Manual Balancing Valve
- S-1830 (1) Combination Isolation Valve
- S-1800 (1) Union

Features

Sizes: ½ to 2"

Material #	Model	Size	Min/Max Flow Rate GPM	Weight Lbs	List Price
NCC1S006	NCC1S	½"	1.2/5.0	2.55	\$ 217.00
NCC1S008	NCC1S	¾"	2.4/10.0	3.03	234.00
NCC1S00A	NCC1S	1"	4.3/18.0	3.81	299.00
NCC1S00B	NCC1S	1¼"	9.0/33.0	5.77	396.00
NCC1S00C	NCC1S	1½"	13/49.0	7.39	501.00
NCC1S00D	NCC1S	2"	24/78.0	11.01	651.00

Note: Flexible hoses are not included and must be added separately

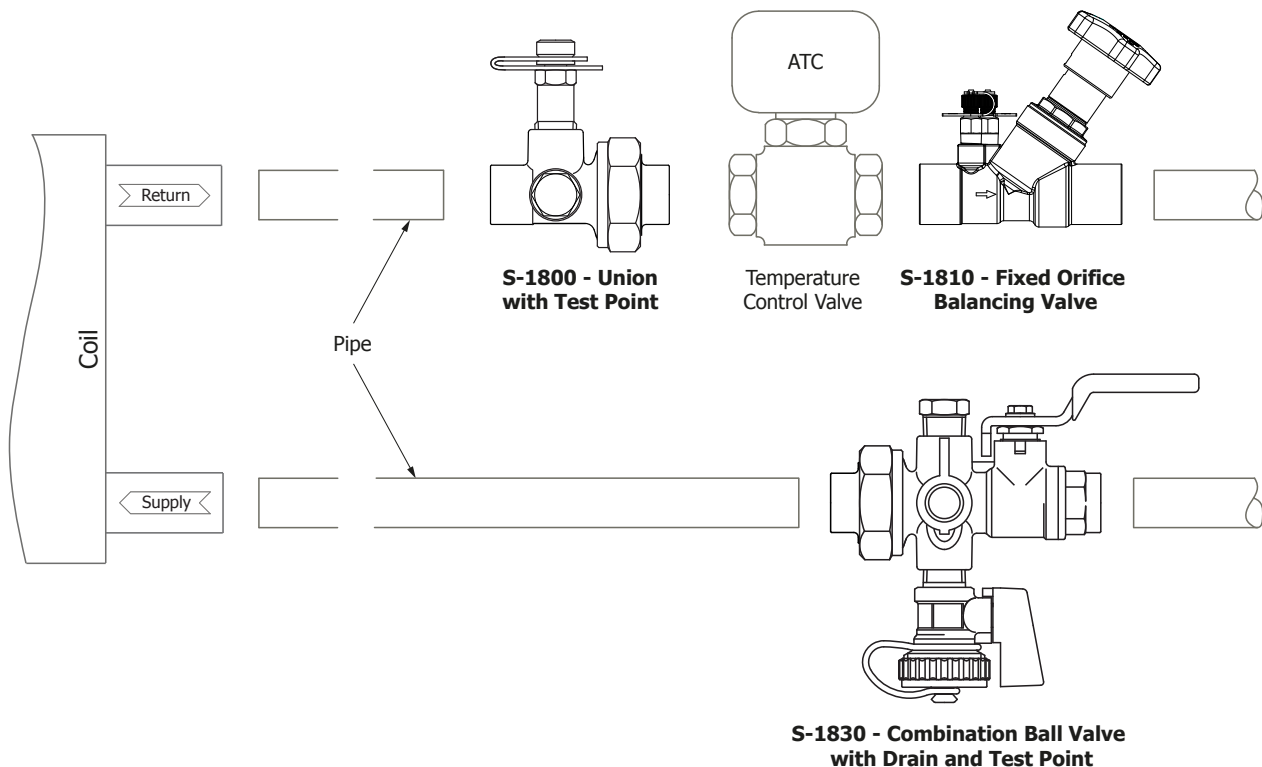

COIL-CONNECT® PREPACKAGED COIL KITS



FLO-BOSS™

Manual Coil-Connect® Kit with Isolation Valve
NCC1P – Press

Includes

- TPC-1810 (1) Manual Balancing Valve
- PCT-1830 (1) Combination Isolation Valve
- T-1800 (1) Union

Features

Sizes: ½ to 2"

Material #	Model	Size	Min/Max Flow Rate GPM	Weight Lbs	List Price
NCC1P006	NCC1P	½"	1.2/5.0	2.96	\$ 262.00
NCC1P008	NCC1P	¾"	2.4/10.0	3.62	281.00
NCC1P00A	NCC1P	1"	4.3/18.0	4.58	358.00
NCC1P00B	NCC1P	1¼"	9.0/33.0	7.09	465.00
NCC1P00C	NCC1P	1½"	13/49.0	9.13	604.00
NCC1P00D	NCC1P	2"	24/78.0	12.89	756.00

Note: Flexible hoses are not included and must be added separately

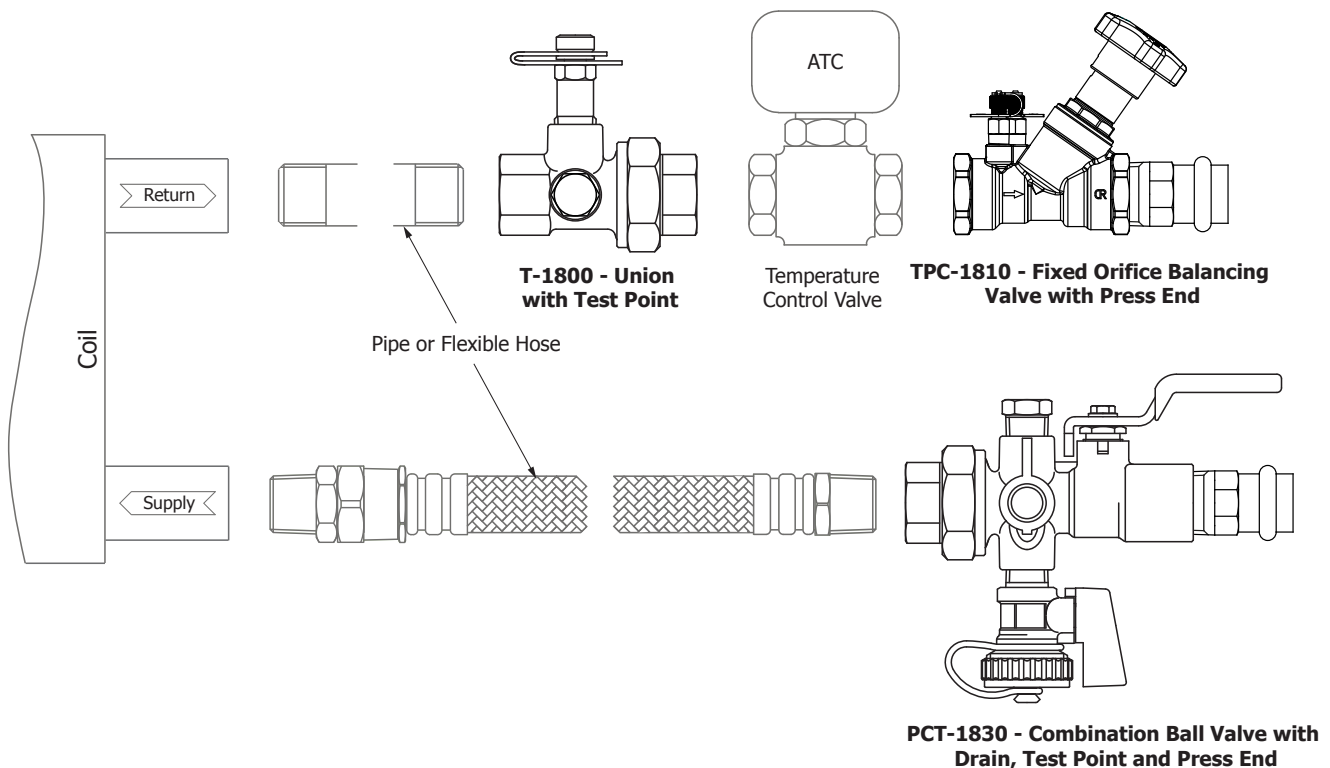



FLO-BOSS™

Manual Coil-Connect® Kit with Strainer Valve

NCC2T – Threaded

Includes

- T-1810 (1) Manual Balancing Valve
- T-1820 (1) Combination Strainer Valve
- T-1800 (1) Union

Features

Sizes: ½ to 2"

Material #	Model	Size	Min/Max Flow Rate GPM	Weight Lbs	List Price
NCC2T006	NCC2T	½"	1.2/5.0	2.93	\$ 224.00
NCC2T008	NCC2T	¾"	2.4/10.0	3.47	241.00
NCC2T00A	NCC2T	1"	4.3/18.0	4.34	304.00
NCC2T00B	NCC2T	1¼"	9.0/33.0	6.64	413.00
NCC2T00C	NCC2T	1½"	13/49.0	8.37	529.00
NCC2T00D	NCC2T	2"	24/78.0	12.11	698.00

Note: Flexible hoses are not included and must be added separately

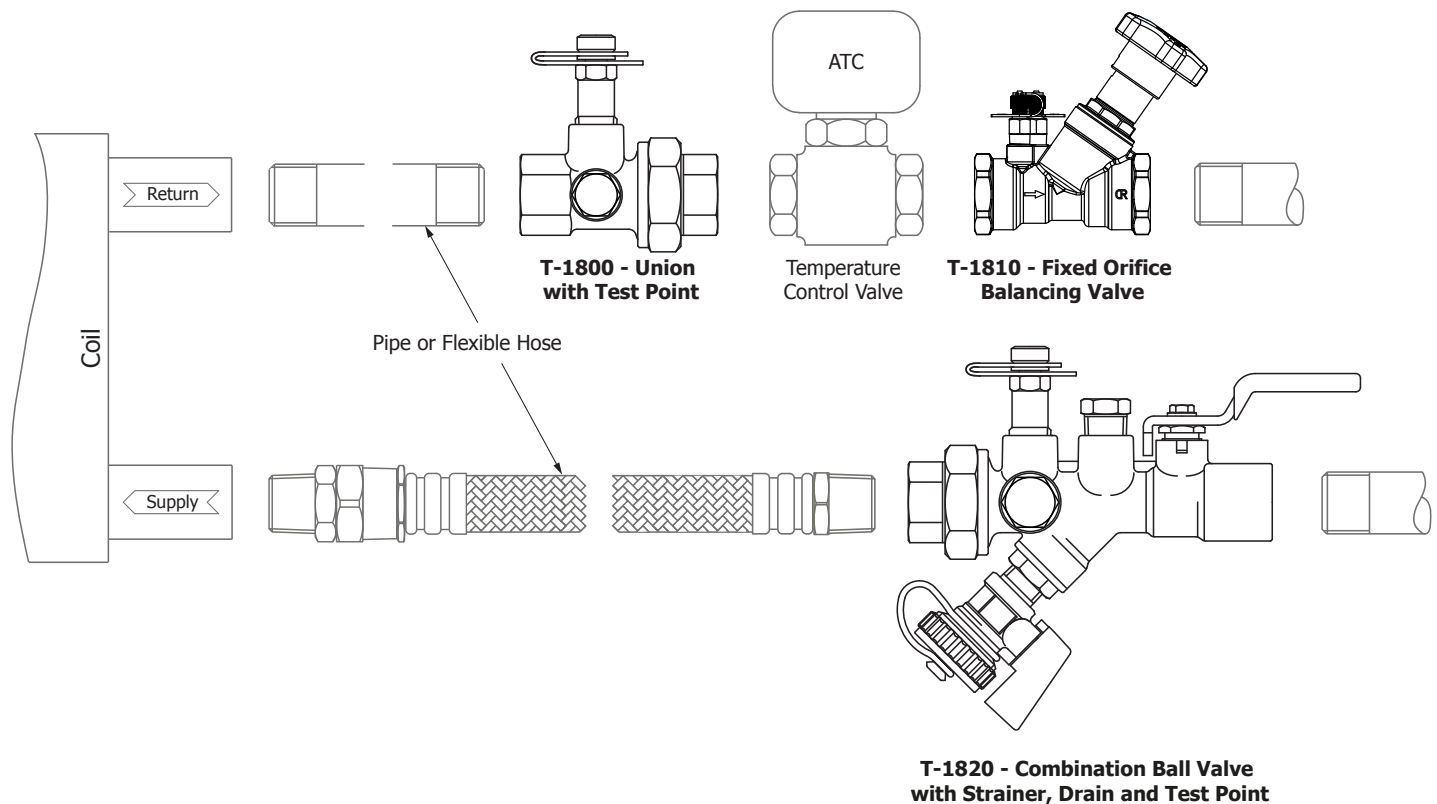

COIL-CONNECT® PREPACKAGED COIL KITS



FLO-BOSS™

Manual Coil-Connect® Kit with Strainer Valve

NCC2S – Solder

Includes

- S-1810 (1) Manual Balancing Valve
- S-1820 (1) Combination Strainer Valve
- S-1800 (1) Union

Features

Sizes: ½ to 2"

Material #	Model	Size	Min/Max Flow Rate GPM	Weight Lbs	List Price
NCC2S006	NCC2S	½"	1.2/5.0	2.74	\$ 224.00
NCC2S008	NCC2S	¾"	2.4/10.0	3.24	241.00
NCC2S00A	NCC2S	1"	4.3/18.0	4.08	304.00
NCC2S00B	NCC2S	1¼"	9.0/33.0	6.36	413.00
NCC2S00C	NCC2S	1½"	13/49.0	8.01	529.00
NCC2S00D	NCC2S	2"	24/78.0	12.06	698.00

Note: Flexible hoses are not included and must be added separately

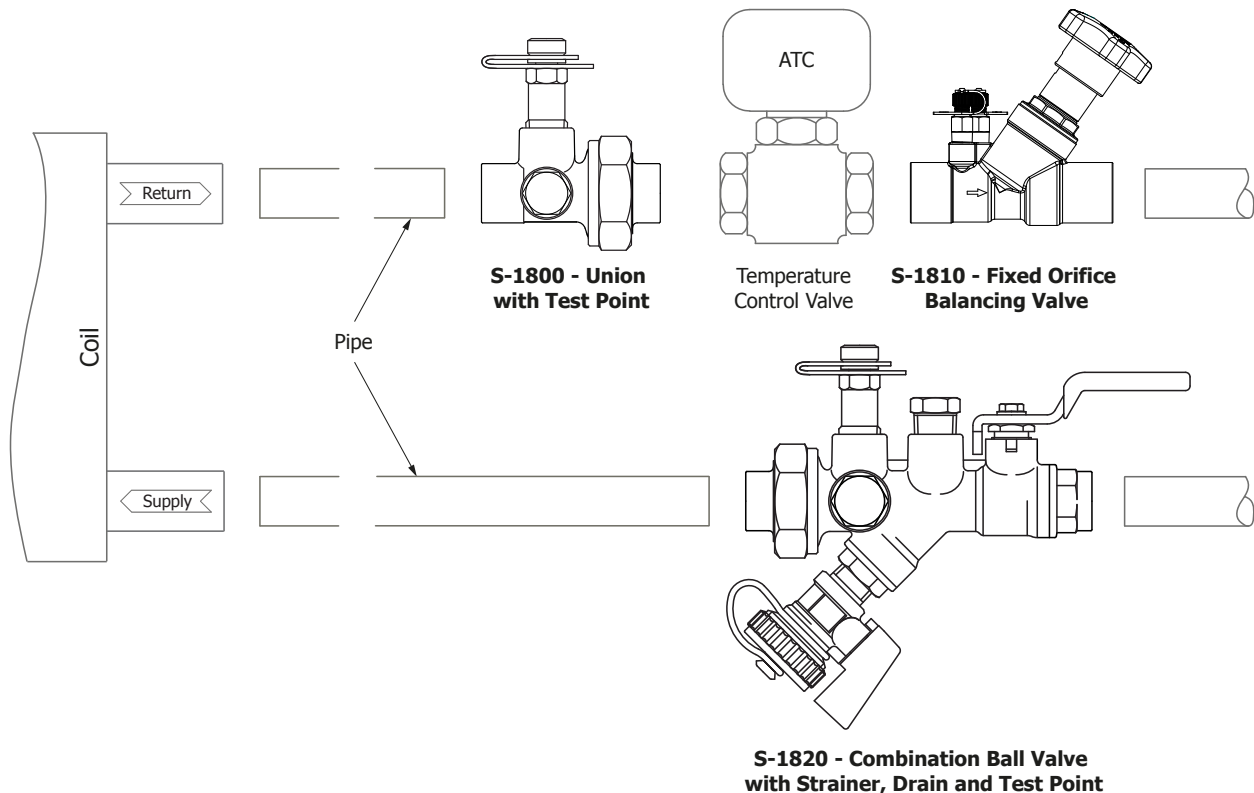



FLO-BOSS™

Manual Coil-Connect® Kit with Strainer Valve

NCC2P – Press

Includes

TPC-1810 (1) Manual Balancing Valve
PCT-1820 (1) Combination Strainer Valve
T-1800 (1) Union

Features

Sizes: ½ to 2"

Material #	Model	Size	Min/Max Flow Rate GPM	Weight Lbs	List Price
NCC2P006	NCC2P	½"	1.2/5.0	3.14	\$ 269.00
NCC2P008	NCC2P	¾"	2.4/10.0	3.86	289.00
NCC2P00A	NCC2P	1"	4.3/18.0	4.88	363.00
NCC2P00B	NCC2P	1¼"	9.0/33.0	7.58	482.00
NCC2P00C	NCC2P	1½"	13/49.0	9.76	632.00
NCC2P00D	NCC2P	2"	24/78.0	13.96	803.00

Note: Flexible hoses are not included and must be added separately

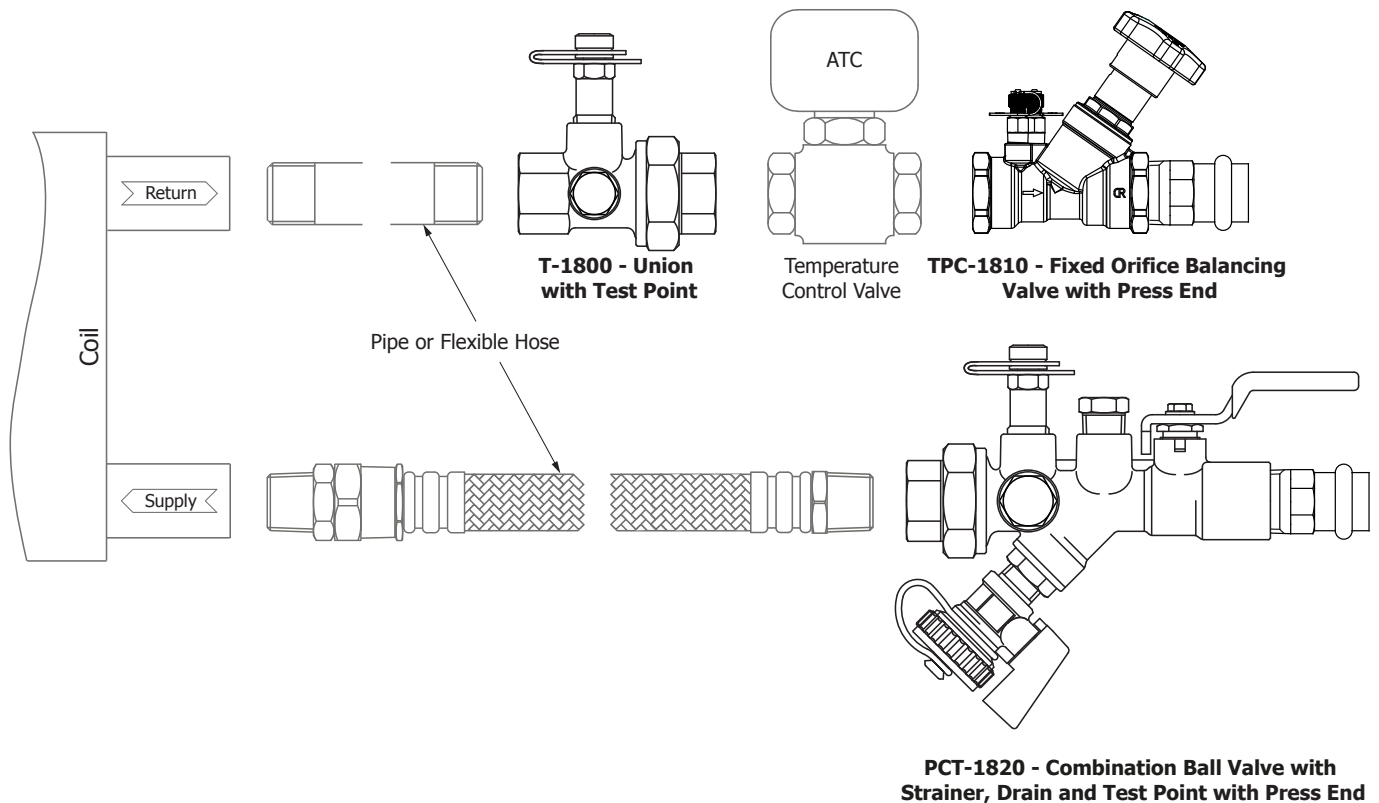

COIL-CONNECT® PREPACKAGED COIL KITS



FLO-BOSS™

Automatic Coil-Connect® Kit with Isolation Valve
NCC3T – Threaded

Includes

- T-1880 (1) Automatic Balancing Valve
- T-1830 (1) Combination Isolation Valve
- T-1800 (1) Union

Features

Sizes: ½ to 2"

Material #	Model	Size	Min/Max Flow Rate GPM	Weight Lbs	List Price
NCC3T006	NCC3T	½"	2.06/15.1	2.04	\$ 227.00
NCC3T008	NCC3T	¾"	2.06/15.1	2.23	242.00
NCC3T00A	NCC3T	1"	2.06/15.1	2.62	311.00
NCC3T00B	NCC3T	1¼"	4.44/41.2	5.42	470.00
NCC3T00C	NCC3T	1½"	4.44/41.2	6.24	553.00
NCC3T00D	NCC3T	2"	4.44/41.2	11.83	765.00

Note: Flexible hoses are not included and must be added separately

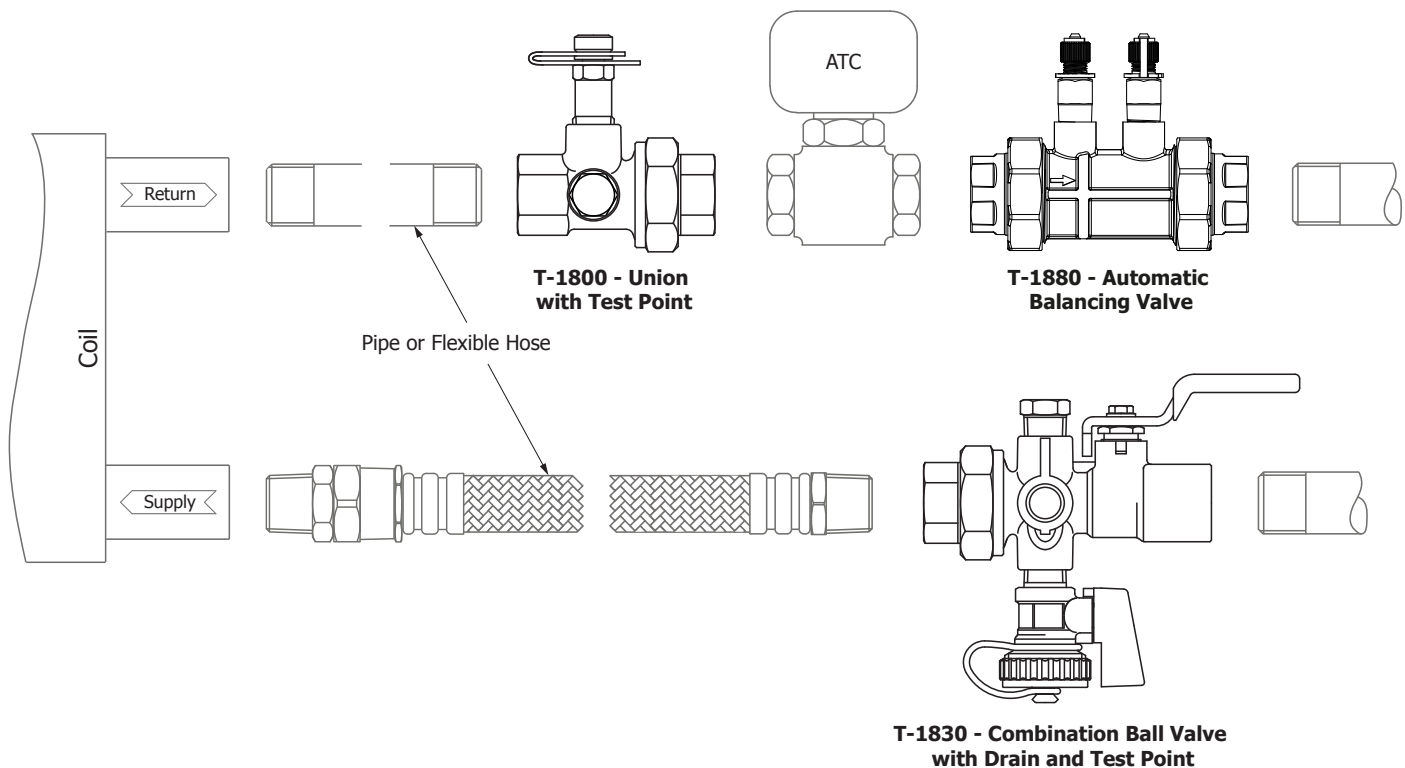

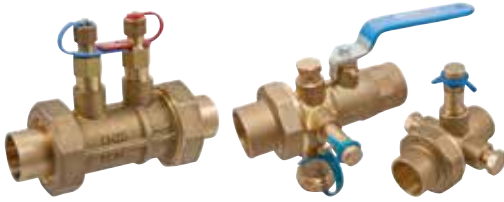

FLO-BOSS™

Automatic Coil-Connect® Kit with Isolation Valve NCC3S – Solder

Includes

- S-1880 (1) Automatic Balancing Valve
- S-1830 (1) Combination Isolation Valve
- S-1800 (1) Union

Features

Sizes: ½ to 2"

Material #	Model	Size	Min/Max Flow Rate GPM	Weight Lbs	List Price
NCC3S006	NCC3S	½"	2.06/15.1	1.97	\$ 227.00
NCC3S008	NCC3S	¾"	2.06/15.1	2.19	242.00
NCC3S00A	NCC3S	1"	2.06/15.1	2.61	311.00
NCC3S00B	NCC3S	1¼"	4.44/41.2	5.34	470.00
NCC3S00C	NCC3S	1½"	4.44/41.2	6.26	553.00
NCC3S00D	NCC3S	2"	4.44/41.2	12.04	765.00

Note: Flexible hoses are not included and must be added separately

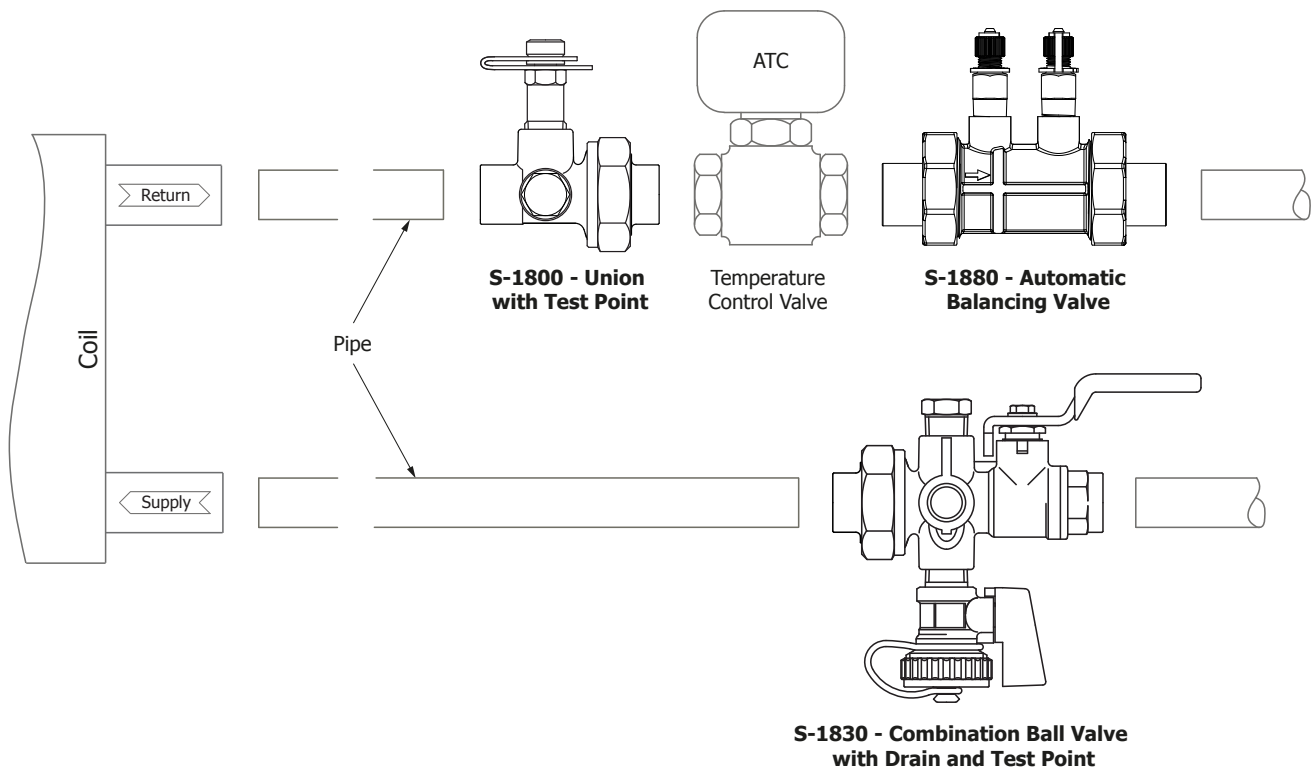

COIL-CONNECT® PREPACKAGED COIL KITS



FLO-BOSS™

Automatic Coil-Connect® Kit with Isolation Valve

NCC3P – Press

Includes

- TPC-1880 (1) Automatic Balancing Valve
- PCT-1830 (1) Combination Isolation Valve
- T-1800 (1) Union

Features

Sizes: ½ to 2"

Material #	Model	Size	Min/Max Flow Rate GPM	Weight Lbs	List Price
NCC3P006	NCC3P	½"	2.06/15.1	2.25	\$ 267.00
NCC3P008	NCC3P	¾"	2.06/15.1	2.62	284.00
NCC3P00A	NCC3P	1"	2.06/15.1	3.16	378.00
NCC3P00B	NCC3P	1¼"	4.44/41.2	6.35	553.00
NCC3P00C	NCC3P	1½"	4.44/41.2	7.63	690.00
NCC3P00D	NCC3P	2"	4.44/41.2	13.68	903.00

Note: Flexible hoses are not included and must be added separately

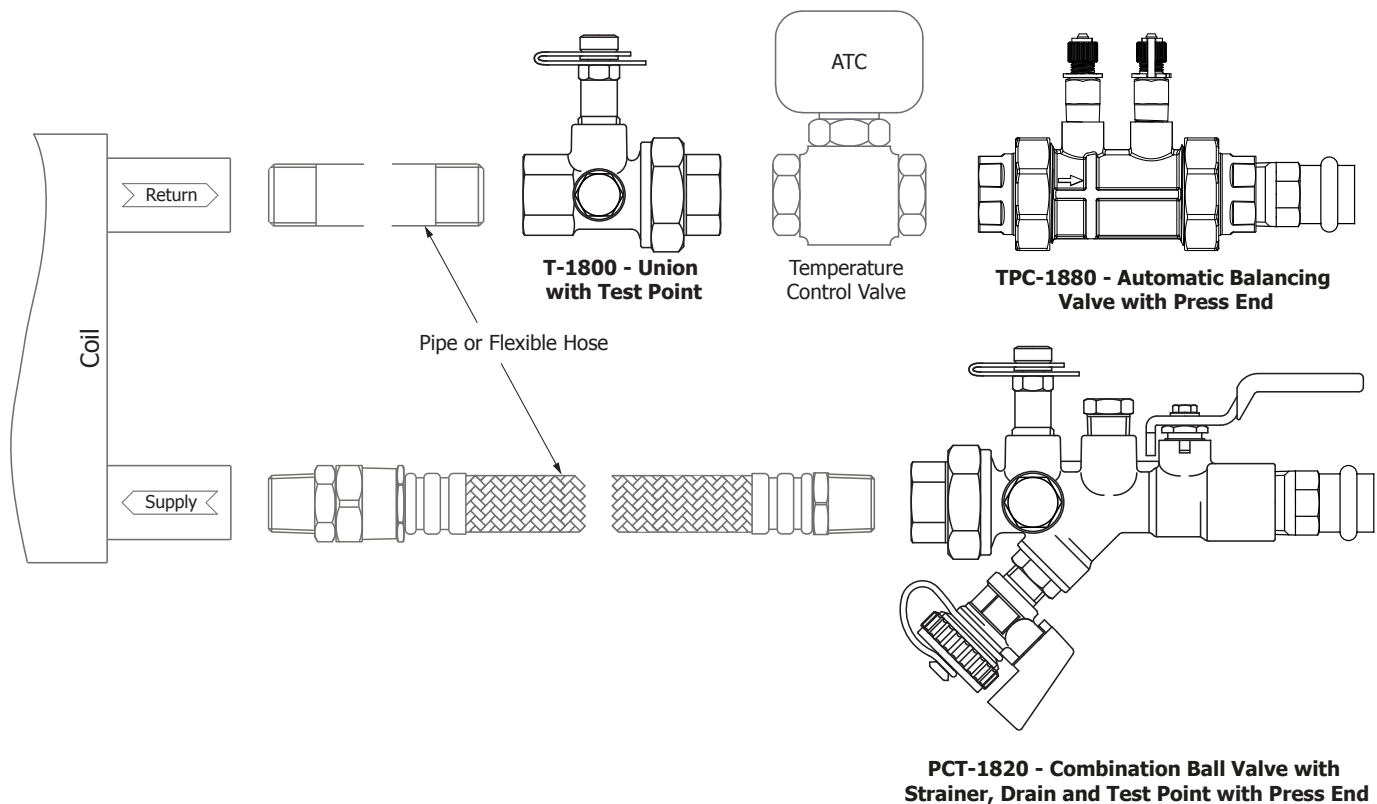



FLO-BOSS™

Automatic Coil-Connect® Kit with Strainer Valve NCC4T – Threaded

Includes

- T-1880 (1) Automatic Balancing Valve
- T-1820 (1) Combination Strainer Valve
- T-1800 (1) Union

Features

Sizes: ½ to 2"

Material #	Model	Size	Min/Max Flow Rate GPM	Weight Lbs	List Price
NCC4T006	NCC4T	½"	2.06/15.1	2.68	\$ 234.00
NCC4T008	NCC4T	¾"	2.06/15.1	3.06	250.00
NCC4T00A	NCC4T	1"	2.06/15.1	3.67	316.00
NCC4T00B	NCC4T	1¼"	4.44/41.2	6.85	487.00
NCC4T00C	NCC4T	1½"	4.44/41.2	8.10	581.00
NCC4T00D	NCC4T	2"	4.44/41.2	13.89	812.00

Note: Flexible hoses are not included and must be added separately

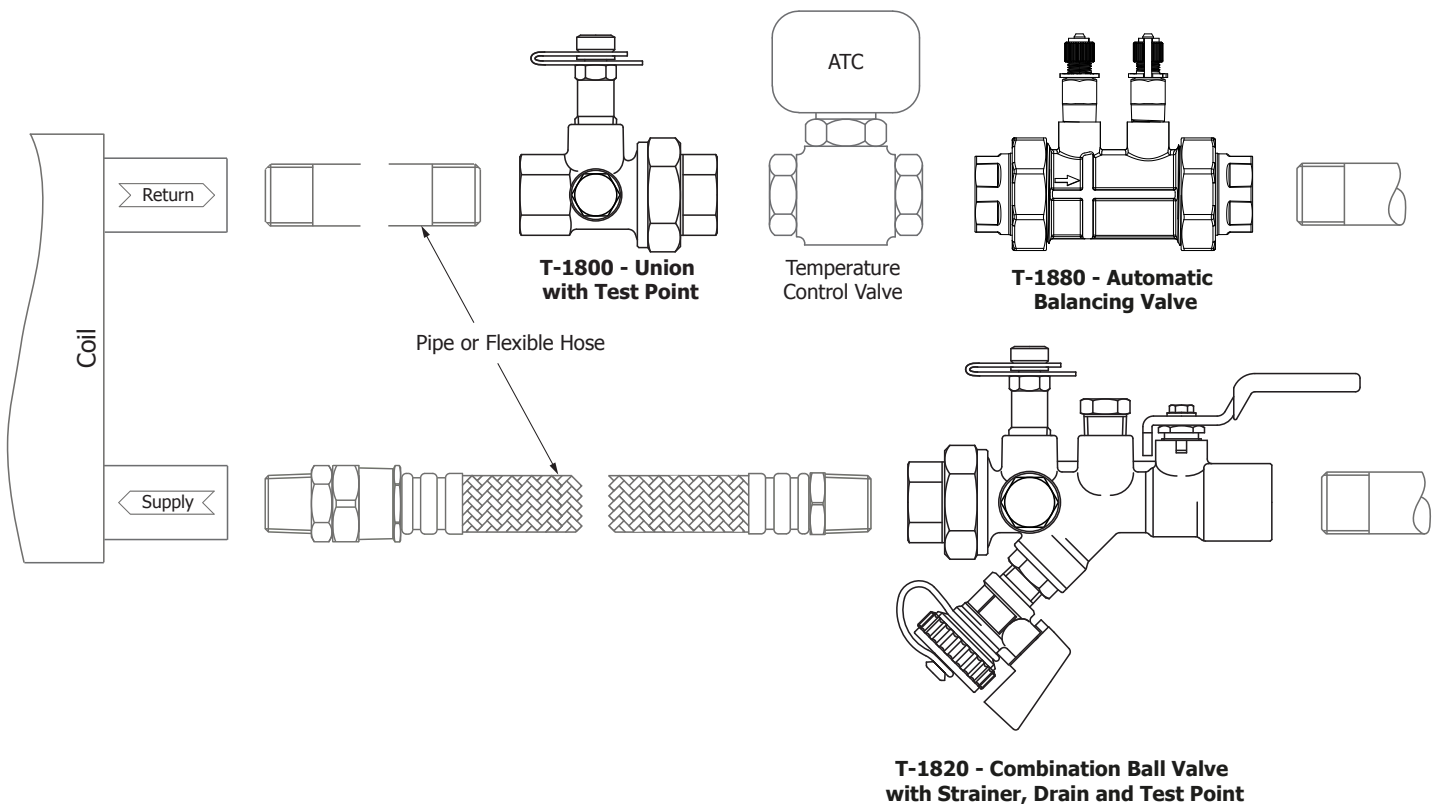

Available in sizes ½" to 2"

COIL-CONNECT® PREPACKAGED COIL KITS



FLO-BOSS™

Automatic Coil-Connect® Kit with Strainer Valve
NCC4S – Solder

Includes

- S-1880 (1) Automatic Balancing Valve
- S-1820 (1) Combination Strainer Valve
- S-1800 (1) Union

Features

Sizes: ½ to 2"

Material #	Model	Size	Min/Max Flow Rate GPM	Weight Lbs	List Price
NCC4S006	NCC4S	½"	2.06/15.1	2.57	\$ 234.00
NCC4S008	NCC4S	¾"	2.06/15.1	2.94	250.00
NCC4S00A	NCC4S	1"	2.06/15.1	3.58	316.00
NCC4S00B	NCC4S	1¼"	4.44/41.2	6.82	487.00
NCC4S00C	NCC4S	1½"	4.44/41.2	8.07	581.00
NCC4S00D	NCC4S	2"	4.44/41.2	14.2	812.00

Note: Flexible hoses are not included and must be added separately

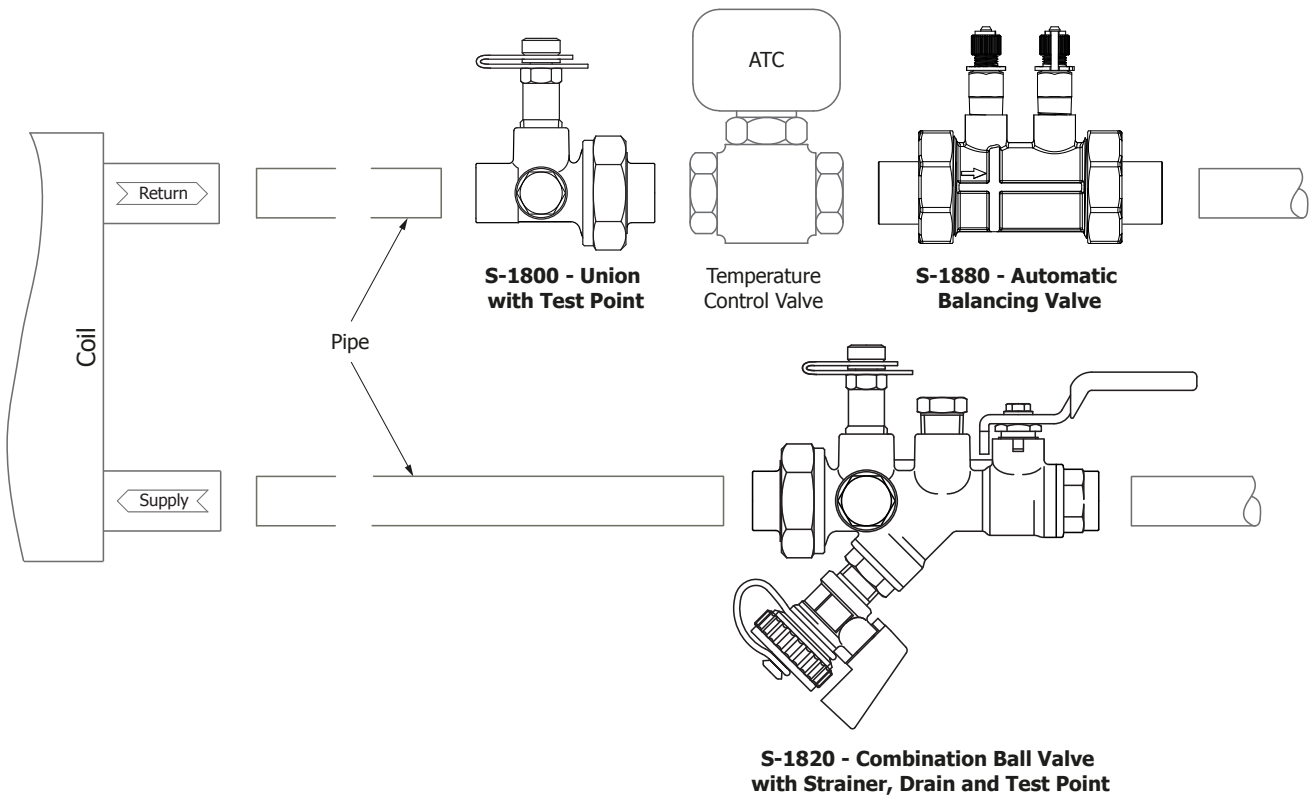

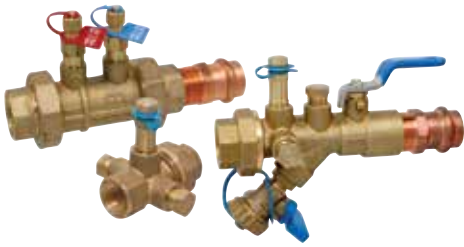

FLO-BOSS™

Automatic Coil-Connect® Kit with Strainer Valve NCC4P – Press

Includes

TPC-1880 (1) Automatic Balancing Valve
PCT-1820 (1) Combination Strainer Valve
T-1800 (1) Union

Features

Sizes: ½ to 2"

Material #	Model	Size	Min/Max Flow Rate GPM	Weight Lbs	List Price
NCC4P006	NCC4P	½"	2.06/15.1	2.89	\$ 274.00
NCC4P008	NCC4P	¾"	2.06/15.1	3.45	292.00
NCC4P00A	NCC4P	1"	2.06/15.1	4.21	383.00
NCC4P00B	NCC4P	1¼"	4.44/41.2	7.78	570.00
NCC4P00C	NCC4P	1½"	4.44/41.2	9.49	718.00
NCC4P00D	NCC4P	2"	4.44/41.2	15.74	950.00

Note: Flexible hoses are not included and must be added separately

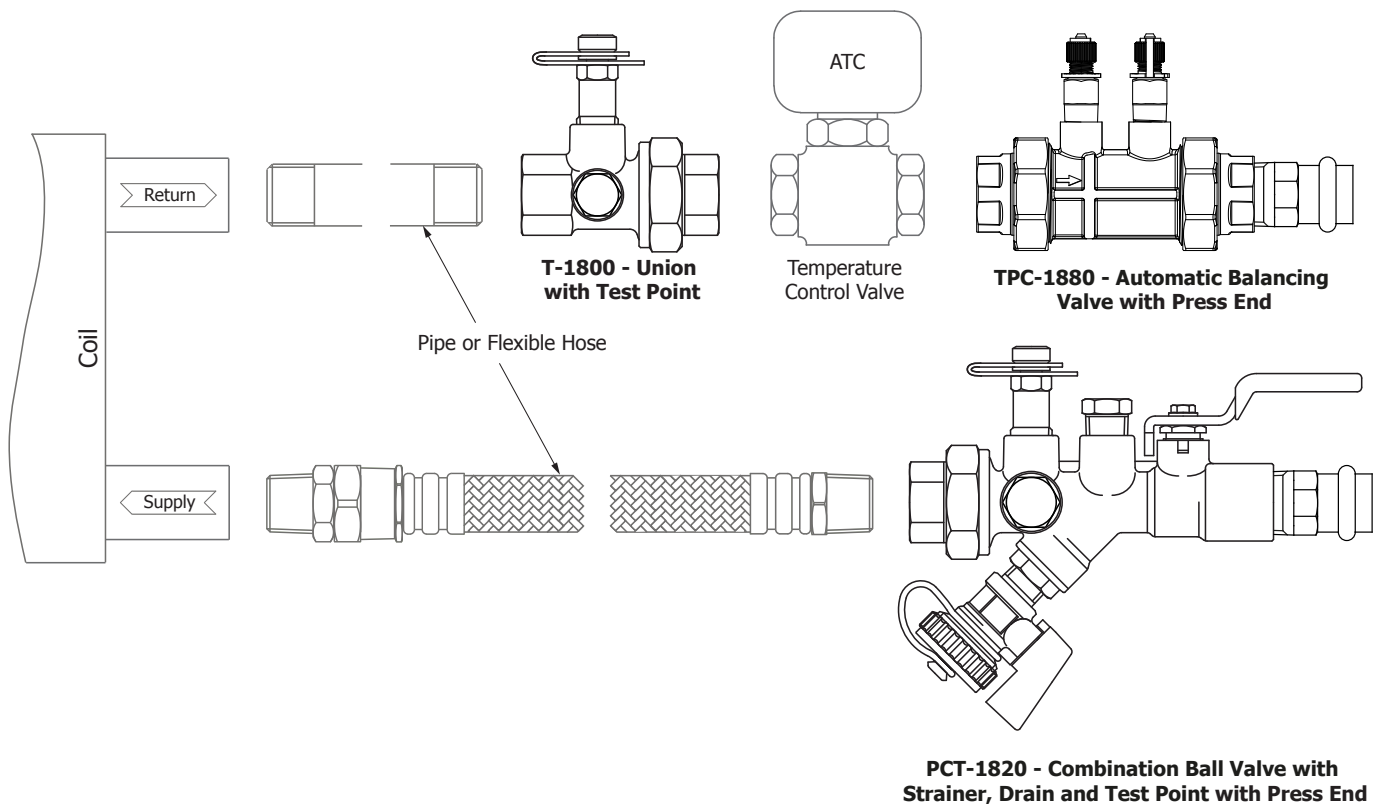

BALANCING AND CONTROLS

OPTIONS AND ACCESSORIES

— A COMPLETE LINE OF HOSES, AIR VENTS,
EXTENSIONS, PT PORTS, AND METERING
STATIONS TO FIT YOUR PROJECT'S NEEDS





Stainless Steel Hose Assembly

1940 – MPT x MPT

Features

Sizes: ½ to 1¼"

Stainless Steel

Material #	Model	Size	Weight Lbs	Qty	List Price
RGC2001	1940	½" x 12"	0.61	1	\$ 43.00
RGC3001	1940	½" x 18"	0.70	1	45.00
RGC4001	1940	½" x 24"	0.79	1	47.00
RGC2005	1940	½" x 36"	0.97	1	86.00
RGC2002	1940	¾" x 12"	0.99	1	68.00
RGC3002	1940	¾" x 18"	1.12	1	70.00
RGC4002	1940	¾" x 24"	1.25	1	71.00
RGC2006	1940	¾" x 36"	1.50	1	117.00
RGC2003	1940	1" x 12"	2.04	1	106.00
RGC3003	1940	1" x 18"	2.23	1	112.00
RGC4003	1940	1" x 24"	2.42	1	120.00
RGC2007	1940	1" x 36"	2.80	1	189.00
RGC2004	1940	1¼" x 12"	3.06	1	197.00
RGC3004	1940	1¼" x 18"	3.32	1	215.00
RGC4004	1940	1¼" x 24"	3.58	1	232.00
RGC2008	1940	1¼" x 36"	4.10	1	286.00



Stainless Steel Hose Assembly 1940 – MPT x Press

Features

Sizes: ½ to 1¼"
Stainless Steel

Material #	Model	Size	Weight Lbs	Qty	List Price
RGC2001PC	1940	½" x 12"	0.71	1	\$ 87.00
RGC3001PC	1940	½" x 18"	0.80	1	92.00
RGC4001PC	1940	½" x 24"	0.90	1	97.00
RGC2005PC	1940	½" x 36"	1.10	1	108.00
RGC2002PC	1940	¾" x 12"	1.15	1	107.00
RGC3002PC	1940	¾" x 18"	1.28	1	116.00
RGC4002PC	1940	¾" x 24"	1.41	1	124.00
RGC2006PC	1940	¾" x 36"	1.70	1	140.00
RGC2003PC	1940	1" x 12"	2.28	1	189.00
RGC3003PC	1940	1" x 18"	2.50	1	202.00
RGC4003PC	1940	1" x 24"	2.70	1	215.10
RGC2007PC	1940	1" x 36"	3.00	1	242.00
RGC2004PC	1940	1¼" x 12"	3.43	1	290.00
RGC3004PC	1940	1¼" x 18"	3.70	1	309.00
RGC4004PC	1940	1¼" x 24"	3.95	1	329.00
RGC2008PC	1940	1¼" x 36"	4.50	1	366.00



Stainless Steel Hose Assembly

1950 – MPT x MPT

Features

Sizes: 1½" to 2"

Material #	Model	Size	Weight Lbs	Box Qty	List Price
RGC5001	1950	1½" x 12"	4.10	1	\$ 311.00
RGC6001	1950	1½" x 18"	4.40	1	437.70
RGC7001	1950	1½" x 24"	4.71	1	496.10
RGC2009	1950	1½" x 36"	5.32	1	483.48
RGC5002	1950	2" x 12"	7.46	1	475.00
RGC6002	1950	2" x 18"	7.92	1	480.00
RGC7002	1950	2" x 24"	8.37	1	490.00
RGC2010	1950	2" x 36"	9.28	1	602.17



Stainless Steel Hose Assembly

1950 – MPT x Press

Features

Sizes: 1½" to 2"

Material #	Model	Size	Weight Lbs	Box Qty	List Price
RGC5001PC	1950	1½" x 12"	4.62	1	\$ 380.83
RGC6001PC	1950	1½" x 18"	4.92	1	437.70
RGC7001PC	1950	1½" x 24"	5.23	1	496.10
RGC2009PC	1950	1½" x 36"	5.80	1	616.55
RGC5002PC	1950	2" x 12"	8.20	1	458.00
RGC6002PC	1950	2" x 18"	8.60	1	531.45
RGC7002PC	1950	2" x 24"	9.10	1	613.00
RGC2010PC	1950	2" x 36"	10.00	1	763.35



Brass Male Hose Adapter 1901 – JIC x SWT

Features

Sizes: ½ to 1-¼"
Stainless Steel

Material #	Model	Size	Weight Lbs	Bag Qty	List Price
RGC1001	1901	½"	0.05	1	\$ 14.50
RGC1002	1901	¾"	0.30	1	26.00
RGC1003	1901	1"	0.40	1	47.00
RGC1004	1901	1¼"	0.60	1	68.00



1/4" Automatic Air Vent 1902

Features

Sizes: ½ - 2"

Material #	Model	Size	Weight Lbs	Bag Qty	List Price
NMB2023	1902	¼"	0.01	1	\$ 13.68



1/4" Manual Air Vent 1903

Features

Sizes: ½ - 2"

Material #	Model	Size	Weight Lbs	Bag Qty	List Price
NMB2024	1903	¼"	0.01	1	\$ 5.85



Air Vent Extension 1/4" x 1.75"

1904

Features

Sizes: 1/4 x 1.75"
Stainless Steel

Material #	Model	Size	Weight Lbs	Bag Qty	List Price
NMMA14	1904	1/4" x 1.75"	0.01	1	\$ 6.00



Brass Close Nipples

1910

Features

Sizes: 1/4 to 2"
Brass

Material #	Model	Size	Weight Lbs	Bag Qty	List Price
NMB2007	1910	1/4"	0.01	1	\$ 14.00
NMB2008	1910	3/8"	0.01	1	15.00
NMB2009	1910	1/2"	0.01	1	17.00
NMB2010	1910	3/4"	0.01	1	24.00
NMB2011	1910	1"	0.02	1	31.00
NMB2012	1910	1 1/4"	0.03	1	47.00
NMB2013	1910	1 1/2"	0.04	1	53.00
NMB2014	1910	2"	0.06	1	67.00



3" Brass Nipples

1911

Features

Sizes: ¼ to 2"

Material #	Model	Size	Weight Lbs	Bag Qty	List Price
NMB2015	1911	¼"	0.01	1	\$ 24.00
NMB2016	1911	3/8"	0.02	1	29.00
NMB2017	1911	½"	0.02	1	31.00
NMB2018	1911	¾"	0.03	1	39.00
NMB2019	1911	1"	0.04	1	51.00
NMB2020	1911	1¼"	0.06	1	70.00
NMB2021	1911	1½"	0.07	1	92.00
NMB2022	1911	2"	0.09	1	90.00



PT Port Extension

1920

Features

Sizes: ¼"

Material #	Model	Size	Weight Lbs	Bag Qty	List Price
NMB2025	1920	¼"	0.01	1	\$ 6.00



1/4" Ball Valve for Air Vent & for Automatic Isolation

1905 – MPT x FPT

Features

Sizes: ¼"

Material #	Model	Size	Weight Lbs	Bag Qty	List Price
NMAVBV14	1905	¼"	0.01	1	\$ 9.00



1820/1830 Handle Extension

1955

Features

Sizes: ½" - 1"
1¼" - 1½"
2"

Material #	Model	Size	Weight Lbs	Bag Qty	List Price
RGNM01A	1955	½" - 1"	0.12	1	\$ 9.00
RGNM01D	1955	1¼" - 1½"	0.18	1	12.00
RGNM01E	1955	2"	0.26	1	15.00



NPT Drain Valve with Cap

1960

Features

Sizes: ¼" - ½"

Material #	Model	Size	Weight Lbs	Bag Qty	List Price
RGC0001	1960	¼"	0.19	1	\$ 7.00
RGC0002	1960	½"	0.24	1	8.00



1/4" NPT PT Port

1970

Features

Sizes: ¼"

Material #	Model	Size	Weight Lbs	Bag Qty	List Price
RGC0003	1970	¼"	0.05	1	\$ 3.00



NPT Plug
1990

Features

Sizes: 1/4"

Material #	Model	Size	Weight Lbs	Bag Qty	List Price
RG0004	1990	1/4"	0.03	1	\$ 9.80



Metering Station
M2000

Features

Sizes: 2 1/2" to 12"

Material #	Model	Size	Weight Lbs	Bag Qty	List Price
RG10210	M2000	2 1/2"	3.5	1	\$ 287.00
RG10220	M2000	3"	4.2	1	217.00
RG10230	M2000	4"	4.6	1	373.00
RG10240	M2000	5"	6.2	1	429.00
RG10250	M2000	6"	7.3	1	536.00
RG10260	M2000	8"	11.0	1	689.00
RG10270	M2000	10"	13.2	1	900.00
RG10280	M2000	12"	22.0	1	957.00
RG10290	M2000	14"	27.5	1	1,798.00
RG10300	M2000	16"	33.0	1	2,199.00
RG10305	M2000	18"	38.5	1	3,199.00



Handwheel for 1710 Series Valve **1709H & 1710H**

Features

Sizes: ½" & ¾"
1¼" - 1½"
2"

Material #	Model	Size	Weight Lbs	Bag Qty	List Price
RG10030	1709H	½" & ¾"	0.05	1	\$ 19.00
RG10010	1710H	½" - 1¼"	0.10	1	27.00
RG10020	1710H	1½" - 2"	0.10	1	54.00



Test Points **1710TP**

Features

Sizes: ½" & ¾"
1¼" - 1½"
2"

Material #	Model	Size	Weight Lbs	Units Per Card	List Price
RG10050	1710TP	½" - 1¼"	0.06	10	\$ 13.00
T118129 KIT	1710TP	1½" & 2"	1.0	2	26.00



Auto Flow Differential Pressure Test Kit **1022**

Features

Pressure Range: 0-30psi/Soft Water Column
Accuracy: +/-2% Full Scale (ascending)
ASME B40.100 Grade B

Material #	Model	Weight Lbs	List Price
RG10000	1022	9.9	\$ 1,373.00

NIBCO® **FLO-BOSS™**

BALANCING & CONTROLS

BVPL-1116

Effective November 28, 2016 · Supersedes BVPL-0115R of January 19, 2015

*Suggested List Prices Subject to Change Without Notice
Visit our website for the most current information*

NIBCO INC.
WORLD HEADQUARTERS

1516 MIDDLEBURY ST.
ELKHART, IN 46516-4740
USA

www.nibco.com

DOMESTIC CUSTOMER SERVICE
PHONE: 800.234.0227
FAX: 800.234.0557

TECHNICAL SERVICE
PHONE: 888.446.4226
FAX: 888.336.4226

INTERNATIONAL OFFICE
PHONE: +1/574.295.3327
FAX: +1/574.295.3455