

TOTO® Owner's Manual

NOTE TO INSTALLER : PLEASE GIVE THIS MANUAL TO THE CUSTOMER AFTER INSTALLATION.

Automatic Soap Dispenser

TOTO SOAP DISPENSER



- Thank you for your recent purchase of the TOTO product. Please read the enclosed information to ensure the safe use of your product.
- Please keep this owner's manual in a safe place.
- **Warranty Registration and Inquiry**
For product warranty registration, TOTO U.S.A. Inc. recommends online Warranty Registration. Please visit our web site <http://www.totousa.com>. If you have questions regarding warranty policy or coverage, please contact TOTO U.S.A. Inc., Customer Service Department, 1155 Southern Road, Morrow, GA 30260 (888) 295 8134 or (678)466-1300 when calling from outside of U.S.A.

Safety Warnings	1	Getting Started
User Warnings	3	
Names and Numbers of Parts	4	
Before Using Your New Product .	5	

How to Use this Product	6	How to Use
Filling the Product with Liquid Soap	7	
Making Adjustments	8	

Day-to-Day Care	9	Maintenance
Recommended Periodic Inspections	10	



Troubleshooting	13	Troubleshooting
Specifications	14	

WARRANTY







Safety Warnings (For your safety, please be sure to follow these guidelines.)

Please read these Safety Warnings carefully in order to use your new product properly.





- After reading the manual, please store it in a place where it can be referred to whenever necessary.
- This owner's manual uses symbols regarding the proper and safe use of this device and can help to prevent harm to yourself or others or damage to assets before they can occur. Those symbols are shown below.





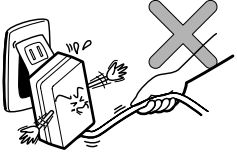
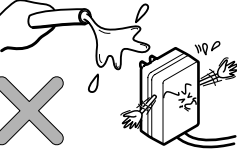
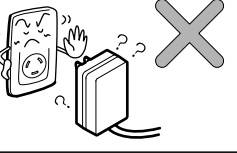

Symbol	Meaning
 Warning	This symbol is used to indicate that it is possible that misuse of the product after ignoring the warning associated with this symbol could result in someone's injury or death.
 Caution	This symbol is used to indicate that it is possible that misuse of the product after ignoring the warning associated with this symbol could result in damage or physical loss.

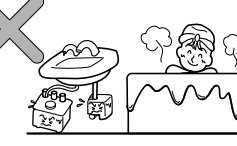

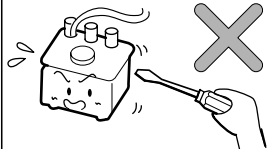

- We have categorized and explained the various activities in the table below.

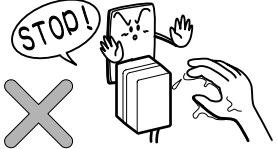
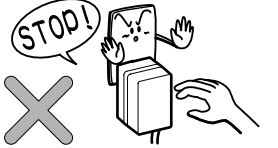
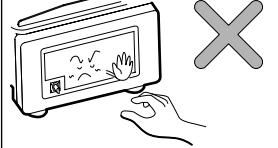
	Indicates something "forbidden" that should not be done.		Please do not touch places marked with this symbol.
	Indicates that the product should not be used in the bath, shower or other wet area.		Please remove the power supply cord from the outlet.
	Please do not disassemble.		Indicates a "required" activity. Please be sure to comply.

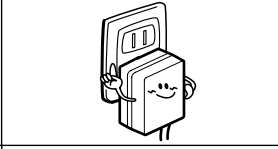
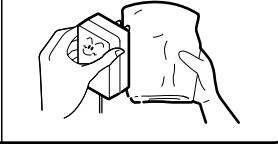





- Depending upon the parts number, the actual item may differ somewhat from the diagram.

 Warning		
 Forbidden	<p>Please do not handle the cord roughly or use an outlet that is not properly tightened.</p> <p>Doing so could cause a fire.</p>	
	<p>Please refrain from pouring water over the power supply plug or the functioning modules.</p> <p>It is an electrical product; doing so could cause a fire or electric shock.</p>	
	<p>Please refrain from connecting the product with a direct current power supply or a power supply with a different voltage.</p> <p>Doing so could cause an electric shock.</p>	
 Do Not Use In Wet Areas	<p>Please do not install in a bathing area or humid place.</p> <p>Doing so could cause product failure or electric shock.</p>	

 Warning		
 Do not Disassemble	<p>Under no circumstances should anyone other than a factory repair technician disassemble, repair or modify any items other than those designated for maintenance or inspection. Doing so could cause product failure or electric shock.</p>	
 Do Not Touch	<p>Please do not touch the power supply plug with wet hands. Doing so could cause product failure or electric shock.</p>	
	<p>Please refrain from touching the power supply plug during thunderstorms or lightning. Doing so could result in an electric shock.</p>	
	<p>Please do not, under any circumstances, touch any internal parts other than the potentiometer knob. Doing so could cause product failure or electric shock.</p>	
 Be Sure to Do This	<p>When plugging the power supply plug into the outlet, please insert the plug fully into place. TOTO recommends that the AC adapter be connected to a GFCI-protected outlet. Not doing so could cause a fire.</p>	
	<p>Please remove any dust found on the power supply plug. If dust builds up on the power supply plug, then moisture could cause the insulation to fail and cause a fire. Please wipe the power supply plug with a dry cloth.</p>	

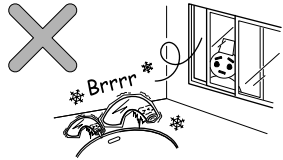
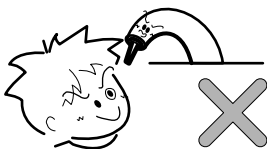
 Caution		
 Forbidden	<p>Please refrain from striking or using excessive force on the product. Doing so could cause product failure or leaking.</p>	
	<p>Please refrain from using disinfectant. Please refrain from using cresol or similar disinfectant in place of liquid soap. Doing so could cause damage to the product or interfere with soap dispensing.</p>	
	<p>Please do not install the product outside. Doing so could cause product failure.</p>	

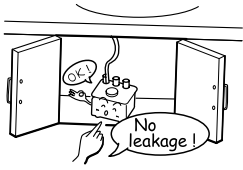
! Caution

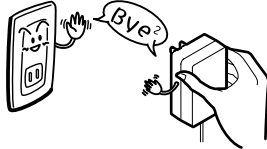
 Forbidden	<p>Please refrain from using liquid soap if rashes, dermatitis or other skin problems become apparent.</p> <p>Not doing so could make symptoms worse.</p>	
	<p>Please do not use this product in a place where the liquid soap in the tank or the water in the pipes can freeze.</p> <p>The devices could rupture, which might leak and damage personal property.</p>	
	<p>Please do not peer inside the nozzle.</p> <p>Doing so could cause soap to get in one's eyes or other injury. In the unlikely event that soap does get in someone's eyes, (remove contact lenses, if applicable) and then rinse the eyes with large amounts of water for at least 15 minutes before immediately seeking the advice of a physician.</p>	
 Be Sure to Do This	<p>Please check regularly, the area around the pipes (inside the cabinet, including inside the inspection port) to make sure that there are no leaks.</p> <p>Not doing so could leave a liquid soap leak, caused by undetected deterioration or wear. A leak could cause damage to personal property.</p>	
 Unplug Product	<p>When the product will go unused for long periods of time, please unplug the power supply.</p> <p>Not doing so could cause an unforeseen accident due to malfunctioning or product failure.</p>	

User Warnings (Please observe the following guidelines.)

- **Please keep obstacles from getting into the sensor area.**

Otherwise the product could malfunction.

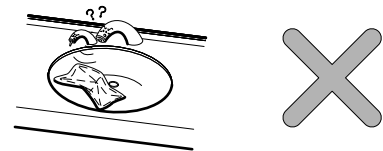

- **Please use a clean container when filling the product.**

The use of paint thinner or other organic solvents or detergents could damage the product or cause other problems.

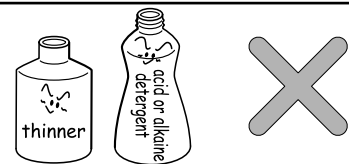

- **Liquid Soap.**

For proper system operation, please use only TOTO® approved soap.

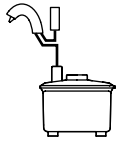
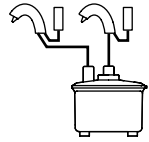
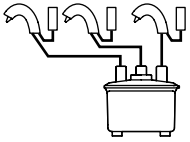

Names and Numbers of Parts

<Standard>			
Item	TES1ADC-05	TES2ADC-05	TES3ADC-05
Base Unit			
Number of Dispenser	1	2	3
Tube and Cord Length	16.4' (5m)		

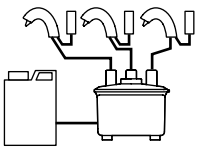
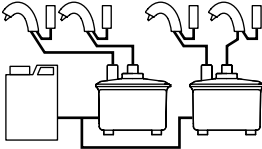
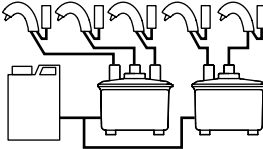
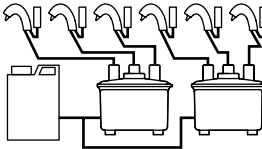
<Special Order Item>				
Item	TES3ADC-12	TES4ADC-12	TES5ADC-12	TES6ADC-12
Base Unit				
Number of Dispenser	3	4	5	6
Tube and Cord Length	39.4' (12m)			

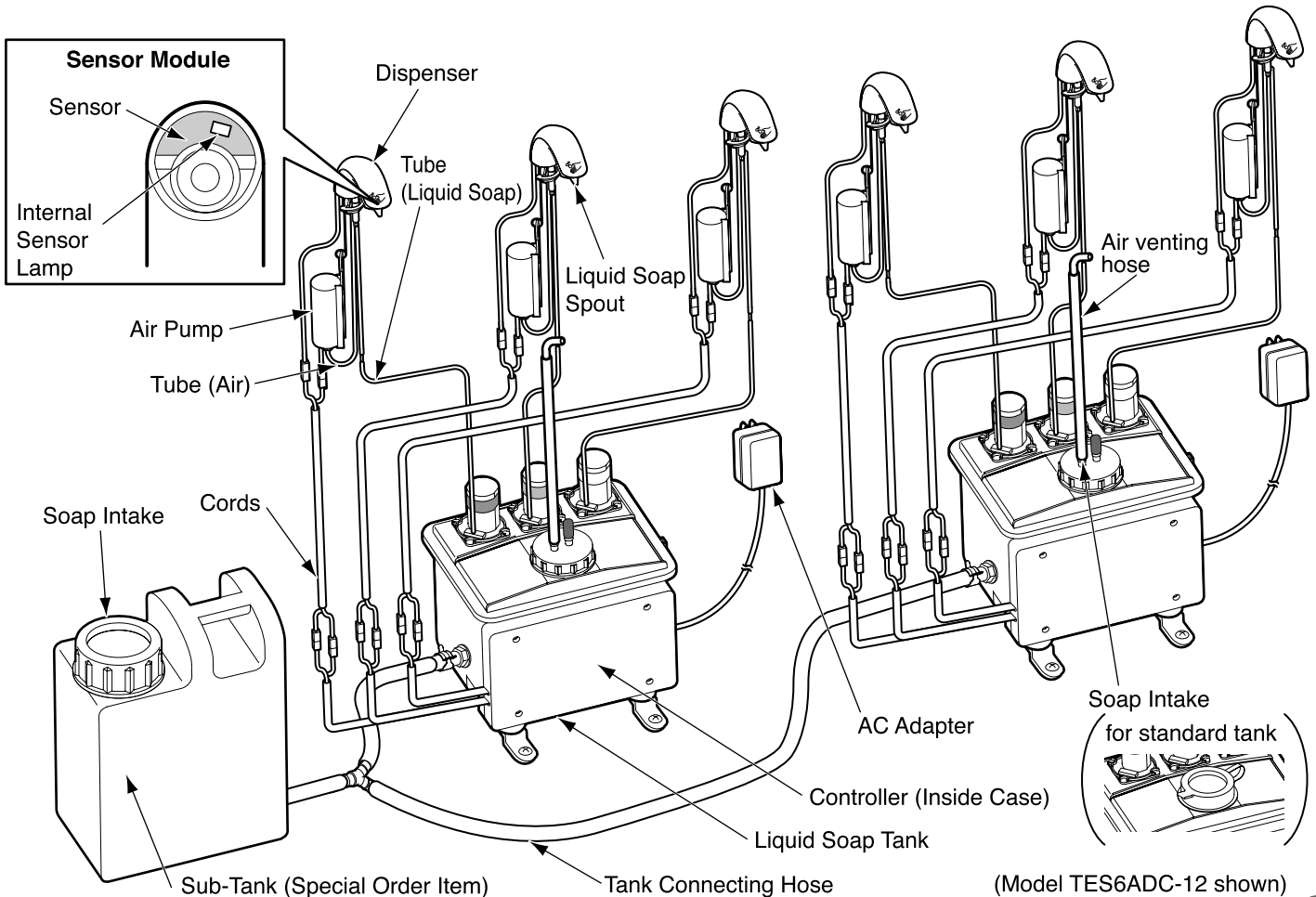

Before Using Your New Product

Checking the Power Supply

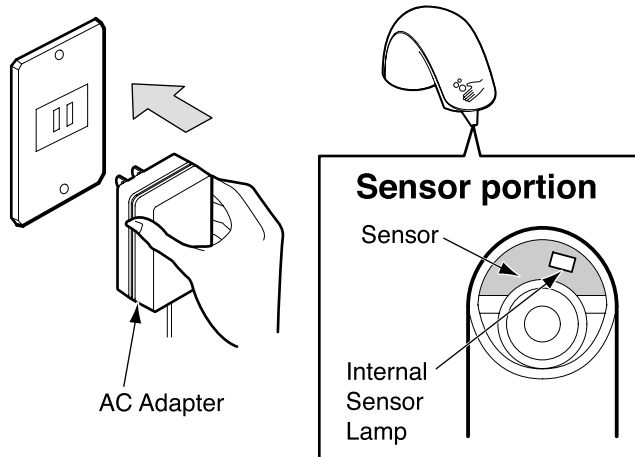

Is the Power On?

Please push the power supply plug completely into the outlet.

Caution

For approximately 10 minutes after turning on the power, the internal sensor lamp will blink every time it senses something. This is not a malfunction. (The lamp will stop blinking after approximately 10 minutes.)

Check the Connections of the Tubes and Hoses

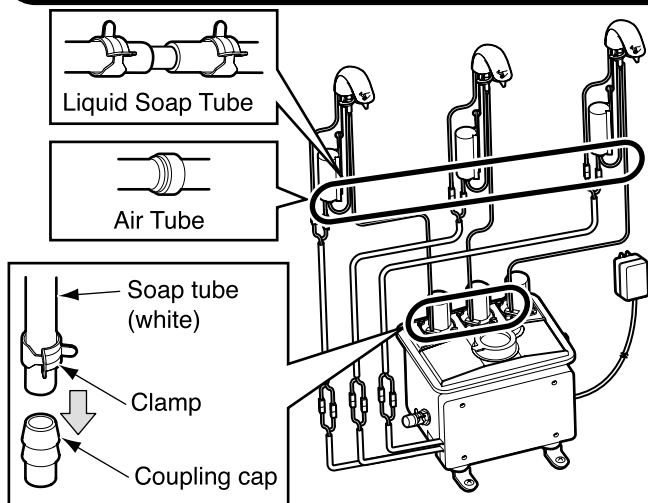

Are the tubes and hoses connected?

Please check to see that the pump module, the liquid soap tube connectors and the air tube connectors are securely connected. When tanks or sub-tanks are connected, please check to see that the connecting hoses are secure.

* Please check to see that there are no sharp kinks in the tubes or hoses.

Checking the Connections of the Connectors

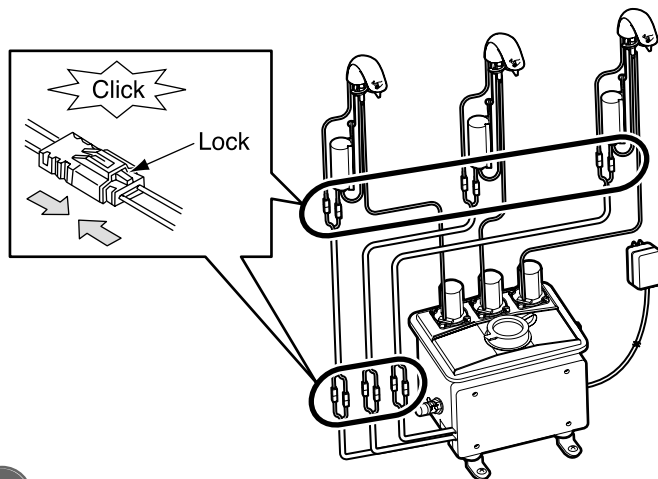

Are the connectors properly connected?

Please check to see that sensor connectors (white) and the air-pump connectors (green) are securely connected.

How to Use this Product

Dispensing Liquid Soap

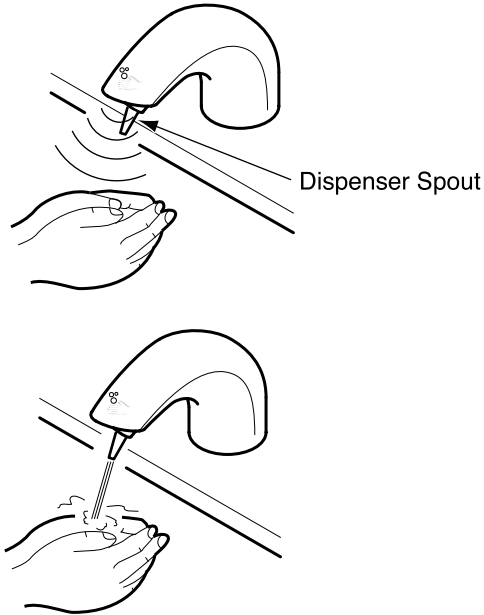

Place Hands Near Dispenser Spout.

- When the sensor senses someone's hands, it dispenses a mousse-like liquid soap.
- The dispensing time is approximately 0.2 second.
- Dispensing stops when the hand is taken away from the dispenser.
- If one's hands remain in front of the dispenser, the mousse-like liquid soap will again be dispensed after approximately a 2-second delay. This process can be repeated up to three times.
- In order to prevent mischief, the liquid soap dispenser will stop after 3 times, but repeated soap dispensing is possible by moving the hands away and placing them in front of the dispenser again.

Caution

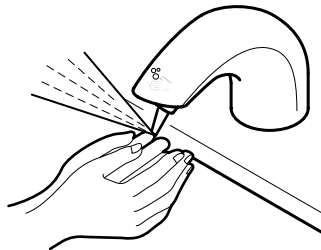
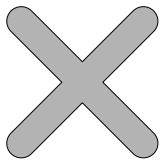

Please do not obstruct the dispenser spout opening.

The soap might go flying off in an unexpected direction.

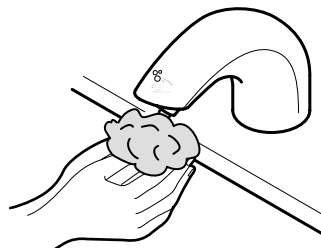
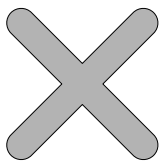

Please do not put foam on the tip of the dispenser. If the sensor becomes soiled, it could malfunction.

When the tip becomes soiled, please wipe away the debris using a damp cloth.

Filling the Product with Liquid Soap

Please refill the liquid soap when the internal sensor lamp (red) starts blinking.

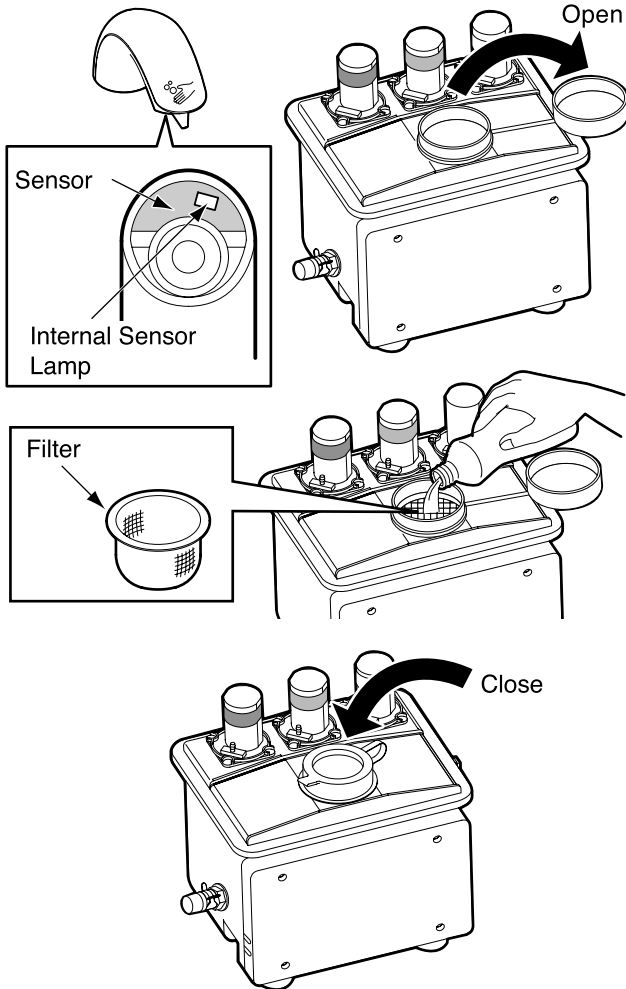

1. Remove the cap on the liquid soap tank.

2. Slowly pour the liquid soap into the holding tank.

Please keep an eye on the level as you pour the liquid soap in slowly so that it doesn't become foamy. Please pour the liquid soap through the built-in filter.

3. Firmly replace the cap on the liquid soap tank.

Please make sure that the cap is securely in place after filling the tank.

Filling the Sub-Tank (Only if a sub-tank has been installed.)

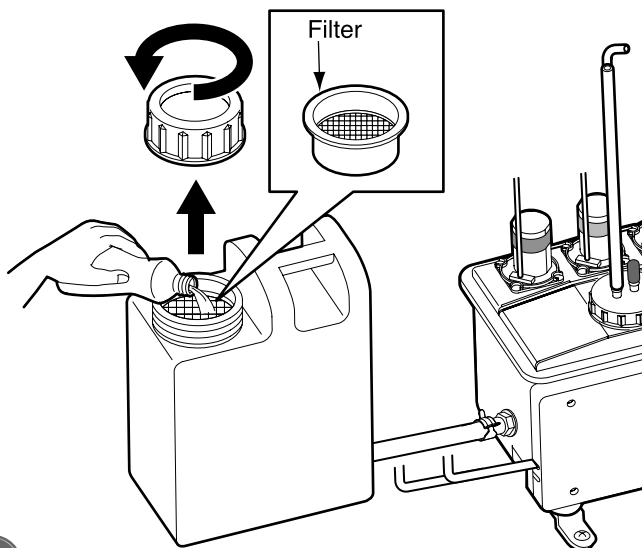

When a sub-tank has been installed, please fill the liquid soap from the opening in the sub-tank.

NOTE: Pour soap slowly to avoid bubbles in the tank.

• If the soap is very slow to drain into the tank or excessive bubbling occurs, please clean the filter and cap area. (see page 11)

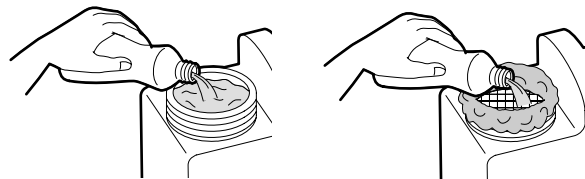

Making Adjustments

Warning



Do Not Touch

Please do not, under any circumstances, touch to any internal parts other than the potentiometer knob.

Doing so could cause product failure or electric shock.

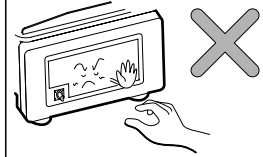

Caution



Unplug Product

When the product will go unused for long periods of time, please unplug the power supply.

Not doing so could cause an unforeseen accident due to malfunctioning or product failure.

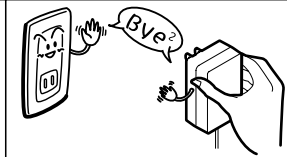

Adjusting the Liquid Soap Dispensing Time

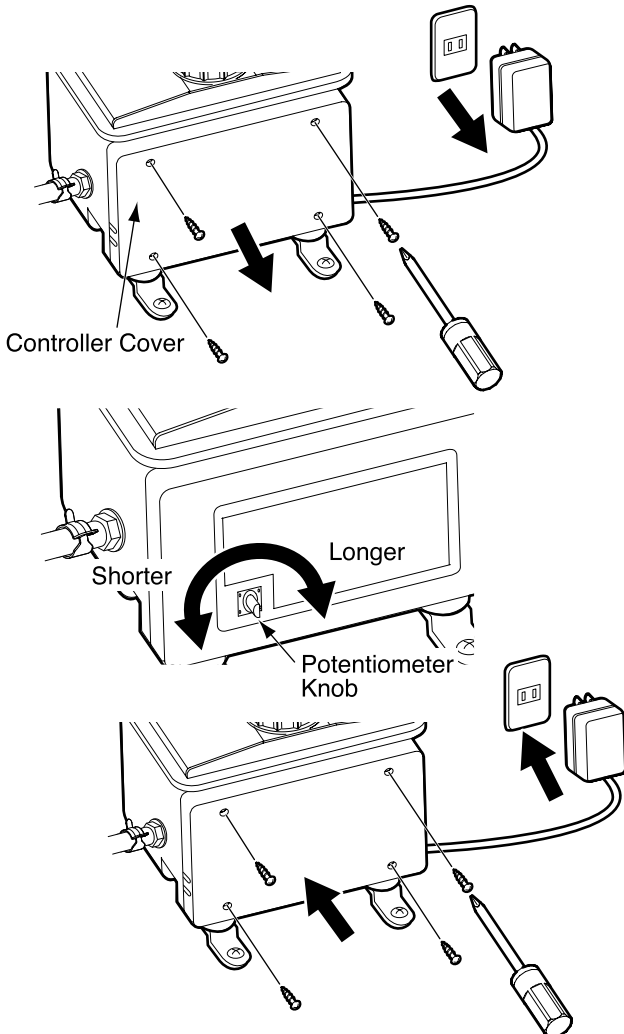

The dispensing time of the liquid soap can be adjusted as necessary from 0.2 seconds to 20 seconds.

* The factory setting is approximately 0.2 second.

1. Remove power supply plug.
2. Using a Phillips head screwdriver, remove the four screws and the controller cover on the side of the tank.
3. Turn the potentiometer knob to adjust the dispensing time.

Please turn the potentiometer knob at the lower left of the base plate and adjust the maximum dispensing time per use.

* The liquid soap dispensing time can be adjusted as follows.
0.2 ~ 2.0 Seconds (in 0.2-second increments)
2.5, 3.0, 5.0, 10.0 or 20.0 seconds

Guide to the Positions of the Potentiometer Knob

0.2 Seconds	1.4 Seconds	2.0 Seconds

4. Replace the Controller Cover.

* Please be careful not to pinch the cords with the lid.

* Please tighten screws fully.

Day-to-Day Care

In order to enjoy your new product, please follow the guidelines below on a day-to-day basis.

Care with a Cloth

● For Light Cleaning

Please wring out a cloth that has been soaked in water and wipe away any debris adhering to the dispenser or sensor.

● For Heavy-Duty Cleaning

After wiping away debris with a cloth containing a suitable amount of a neutral, dishwashing detergent, wipe clean with a damp cloth.



Caution

● *When cleaning around the sensor, please be careful not to scratch the surface of the sensor.*

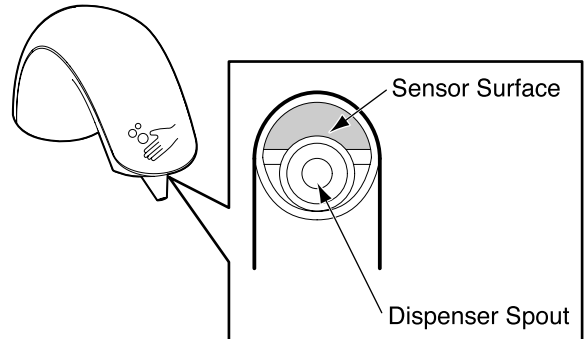

● *Please avoid using cleansers that might scratch the surface of dispenser.*

These include:

- *Detergents containing acid, chlorine bleach or alkali.*
- *Solvents like paint thinner or benzene.*
- *Detergents with coarse granules, polishing powder or cleanser. Nylon scrubbers, pot scrubbers, brushes, etc.*

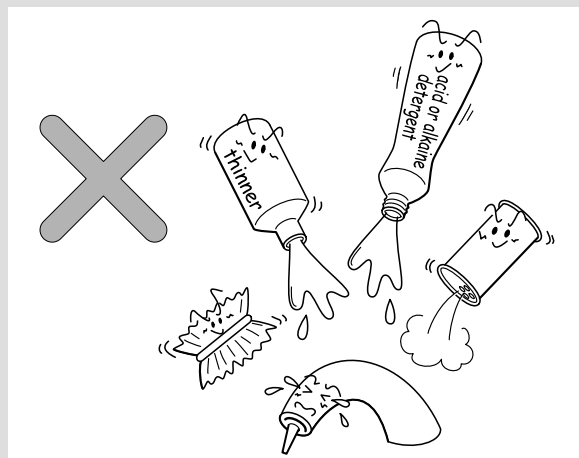

Recommended Periodic Inspections

Please Perform the Following Inspections Once Per Month

⚠ Caution



Unplug Product

When the product will go unused for long periods of time, please unplug the power supply.

Not doing so could cause an unforeseen accident due to malfunctioning or product failure.

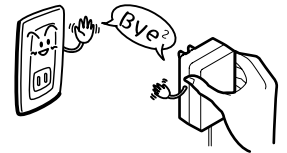

Blocked Dispenser Spout

Occasionally, the dispenser spout or the inside tube may become obstructed by debris and block the liquid soap.

Please clean the dispenser spout and inside tube on a regular basis.

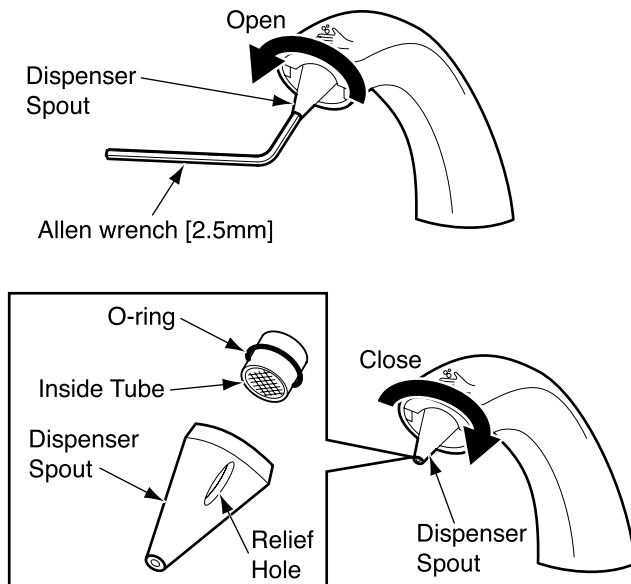

Caution

- If washing the parts in the sink, please cover the drain in advance. The parts are small and there is a chance of losing them.
- When tightening, please adjust the spout so that **the hole in the side of the dispenser spout is pointing straight down.** If not, it could discharge soap in an unexpected direction.

1. Remove the power supply plug from the outlet.

2. Twist the dispenser spout and remove it.

If the blocked nozzle is difficult to turn, please use a 2.5mm allen wrench or similar tool to remove it.

3. Remove the inside tube and “O” ring.

4. Clean (rinse with water) the dispenser spout and the inside tube.

After rinsing with water, dry away the moisture with a soft, dry cloth.

5. After cleaning, replace the parts as they were.

- (1) Place the O-Ring on the inside tube in the dispenser spout.
- (2) When installing the dispenser spout, please do not use any tools. Turn it with your fingers at first.
- (3) Use Allen wrench to adjust the dispenser spout so that **the relief hole is pointing straight down.**

* After re-installing the dispenser spout, check to make sure that the dispenser spout does not leak. If it does, please tighten the joints.

Tightening a Loose Dispenser

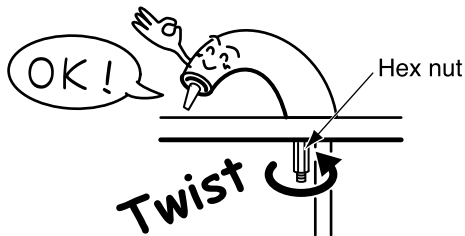

Check to see that the dispenser is not loose.
If the dispenser is loose, please tighten the hexagonal nut on the lower half of the dispenser.

Blocked Liquid Soap Filter

Please clean out the liquid soap filter whenever debris becomes trapped so that the supply of liquid soap will continue smoothly.

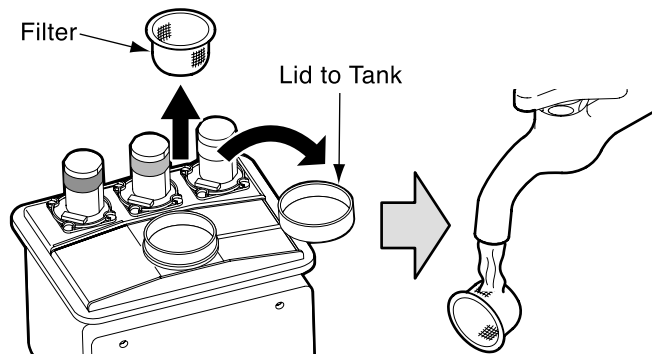

1. Remove the lid on the liquid soap tank.
2. Remove the Filter.
3. Clean (rinse in water) the filter.
4. After cleaning, reassemble the parts.

Blocked Sub-Tank Liquid Soap Filter (Only if a sub-tank has been installed.)

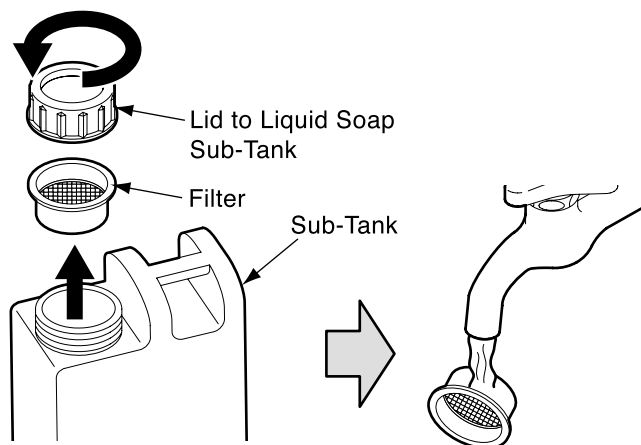

1. Remove the lid on the liquid soap tank.
2. Remove the Filter.
3. Clean (rinse in water) the filter.
4. After cleaning, reassemble the parts.

• Clean the filter with water.
Clean the top of the tank with a damp cloth.

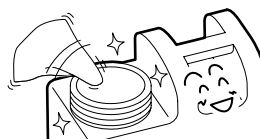

Cleaning Out the Tank Interior

In order to enjoy your new product, please clean the tank as outlined below on a regular basis.

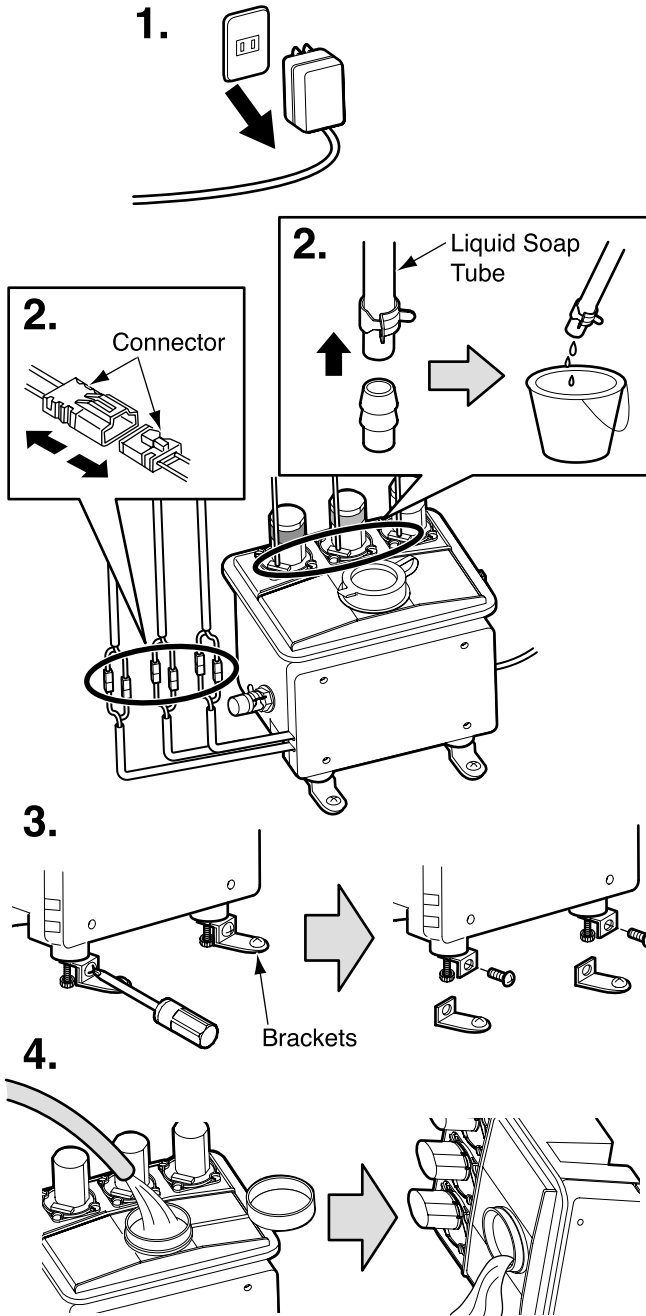

Cleaning the Sub-Tank

When a sub-tank has been installed, please remove the connecting hose and clean the tank.

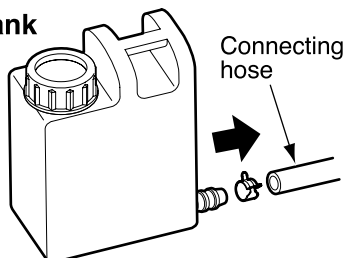

1. Unplug the power supply.
2. Remove the connectors on the cords (white and green).
Remove the tubes from the tank.

Please remove the bands and draw the tubes out of the tank. When the tubes are removed, the liquid soap will flow out, so please catch it using a bucket or the toilet.

* If a sub-tank has been installed, then the cap that connects the air hose in the tank is removed.

3. Loosen the brackets that secure the tank in place.
4. Wash the tank.

Remove the caps and pour water into the tank from the refill port. After rinsing several times, please discard the water.

Caution

Please be careful not to let water get on the connectors or pumps.

5. Return the tank to its original position.
6. Assemble the brackets that secure the device.
7. Attach the connecting air hose to the tank.
(Only if a sub-tank has been installed.)
8. Connect the connectors and tubes to the tank.

Caution

- Please be aware of the orientation of the connectors. Please press them all the way in, until they lock shut.
- Please push the tubes all the way in and secure them carefully with the bands.

Troubleshooting

Warning



**Do not
Disassemble**

Under no circumstances should anyone other than a factory repair technician disassemble, repair or modify any items other than those designated for maintenance or inspection.

Doing so could cause product failure or electric shock.

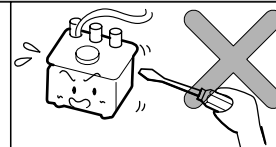

If you experience any of the following, your product is not necessarily broken. Please consult this table before calling for repairs.

If your product still does not function properly, please contact the store or dealership of purchase.

Before Calling for Repairs...

Phenomenon	What to Look For	What to Do	Reference Page
No liquid soap comes out.	Is there soap on the tip of the dispenser or on the surface of the sensor ?	Remove the soap.	9,10
	Does the surface of the sensor need cleaning ?	Clean sensor.	9
	Is something obstructing the front of the sensor ?	Remove the obstruction.	3
	Is the AC adapter plugged into an outlet ?	Plug in the AC adapter.	5
	Are the connectors (white) plugged all the way in ?	Plug in the connectors (white).	5
	Is the power out ?	Wait until power has been restored.	-
	Are the tubes fully and securely connected ?	Insert the tubes.	5
	Is there debris in the dispenser spout or the inside tube?	Clean the dispenser spout or inside tube.	10
	Does the liquid soap tank contain liquid soap ? (Is the internal sensor lamp blinking?)	Fill the tank with liquid soap. (After filling, check to see that the internal sensor lamp has gone out.)	7
	Are you using a high-viscosity liquid soap ?	Please use the recommended liquid soap.	3
It doesn't dispense mousse.	Is the air-pump connector (green) pushed all the way into place?	Push the connector all the way into place.	5
	Is the air tube (blue) pushed all the way into place?	Push the tube all the way into place.	5
Hardly any soap comes out.	Are there any kinks in the tubes ?	Straighten out the kinks in the tubes.	5
	Is debris blocking the dispenser spout or the inside tube ?	Clean out the dispenser spout or the inside tube.	10
	Are you using a high-viscosity liquid soap ?	Please use the recommended liquid soap.	3
Takes too long to refill soap.	Is the inlet filter clogged ?	Clean the inlet filter.	11
Soap won't come out unless you put your hands closer than usual.	If there are drops of water or debris on the sensor surface, the learning mechanism may not function properly. Please keep the sensor surface clean at all times.		
The soap comes out by itself. (There are drips.)	When unused for 48 hours, the dispenser automatically dispenses liquid soap. This is a mechanism for keeping the soap from hardening in the tubes and is not a malfunction.		

Specifications

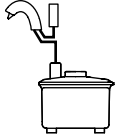
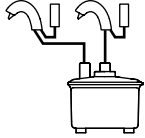
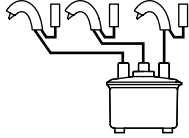
<Standard>			
Item	TES1ADC-05	TES2ADC-05	TES3ADC-05
Configuration			
Number of Dispenser	1	2	3
Tube and Cords	16.4' (5m)		
Sub-Tank	N/A		
Power Source	AC Aapter Input : 120VAC60Hz Output : 24VDC		
Wattage	10W	20W	30W
Detection Range	4"(110mm) (using #300 white paper)*Note that the detection range may vary due to learning methods.		
Ambient Temperature for Use	34~104°F(1~40°C)		
Power Cord Length	71" (1.8m)		
Dispensed Amount of Soap	1mL (at factory setting)		
Tank Capacity	Approximately 1 gallon (4L) (Usable Capacity)		

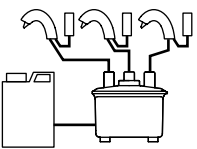
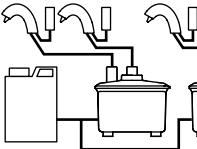
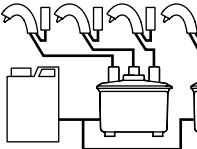
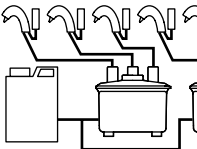
<Special> ... with subtank and 39.4' (12m) tube and cords				
Item	TES3ADC-12	TES4ADC-12	TES5ADC-12	TES6ADC-12
Configuration				
Number of Dispenser	3	4	5	6
Tube and Cords	39.4' (12m)			
Sub-Tank	1set			
Power Source	AC Aapter Input : 120VAC60Hz Output : 24VDC			
Wattage	30W	40W(20W+20W)	50W(20W+30W)	60W(30W+30W)
Detection Range	4"(110mm) (using #300 white paper)*Note that the detection range may vary due to learning methods.			
Ambient Temperature for Use	34~104°F(1~40°C)			
Power Cord Length	71" (1.8m)			
Dispensed Amount of Soap	1mL (at factory setting)			
Tank Capacity	6.8 gallons (26L) (usable capacity)	Approximately 8 gallons (30L) (Usable Capacity)		

WARRANTY

TOTO U.S.A., INC. THREE YEAR LIMITED WARRANTY

1. TOTO warrants its electronic flush valves, faucets and soap dispensers ("Product") to be free from defects in materials and workmanship during normal use when properly installed and serviced, for a period of three (3) years from date of purchase. This limited warranty is extended only to the ORIGINAL PURCHASER of the Product and is not transferable to any third party, including but not limited to any subsequent purchaser or owner of the Product. This warranty applies only to TOTO Product purchased and installed in North, Central and South America.
2. TOTO's obligations under this warranty are limited to repair, replacement or other appropriate adjustment, at TOTO's option, of the Product or parts found to be defective in normal use, provided that such Product was properly installed, used and serviced in accordance with instructions. TOTO reserves the right to make such inspections as may be necessary in order to determine the cause of the defect. TOTO will not charge for labor or parts in connection with warranty repairs or replacements. TOTO is not responsible for the cost of removal, return and/or reinstallation of the Product.
3. This warranty does not apply to the following items:
 - a. Damage or loss sustained in a natural calamity such as fire, earthquake, flood, thunder, electrical storm, etc.
 - b. Damage or loss resulting from any accident, unreasonable use, misuse, abuse, negligence, or improper care, cleaning, or maintenance of the Product.
 - c. Damage or loss resulting from sediments or foreign matter contained in a water system.
 - d. Damage or loss resulting from improper installation or from installation of the Product in a harsh and/or hazardous environment, or improper removal, repair or modification of the Product.
 - e. Damage or loss resulting from electrical surges or lightning strikes or other acts which are not the fault of TOTO or which the Product is not specified to tolerate.
 - f. Damage or loss resulting from normal and customary wear and tear, such as gloss reduction, scratching or fading over time due to use, cleaning practices or water or atmospheric conditions, including but not limited to, the use of bleach, alkali, acid cleaners, dry (powder) cleaners or any other abrasive cleaners or the use of metal or nylon scrubbers.
4. In order for this limited warranty to be valid, proof of purchase is required. TOTO encourages warranty registration upon purchase to create a record of Product ownership at <http://www.totousa.com>. Product registration is completely voluntary and failure to register will not diminish your limited warranty rights.
5. THIS WARRANTY GIVES YOU SPECIFIC LEGAL RIGHTS. YOU MAY HAVE OTHER RIGHTS WHICH VARY FROM STATE TO STATE, PROVINCE TO PROVINCE OR COUNTRY TO COUNTRY.
6. To obtain warranty repair service under this warranty, you must take the Product or deliver it prepaid to a TOTO service facility together with proof of purchase (original sales receipt) and a letter stating the problem, or contact a TOTO distributor or products service contractor, or write directly to TOTO U.S.A., INC., 1155 Southern Road, Morrow, GA 30260 (888) 295 8134 or (678) 466-1300, if outside the U.S.A. If, because of the size of the Product or nature of the defect, the Product cannot be returned to TOTO, receipt by TOTO of written notice of the defect together with proof of purchase (original sales receipt) shall constitute delivery. In such case, TOTO may choose to repair the Product at the purchaser's location or pay to transport the Product to a service facility.

THIS WRITTEN WARRANTY IS THE ONLY WARRANTY MADE BY TOTO. REPAIR, REPLACEMENT OR OTHER APPROPRIATE ADJUSTMENT AS PROVIDED UNDER THIS WARRANTY SHALL BE THE EXCLUSIVE REMEDY AVAILABLE TO THE ORIGINAL PURCHASER. TOTO SHALL NOT BE RESPONSIBLE FOR LOSS OF THE PRODUCT OR FOR OTHER INCIDENTAL, SPECIAL OR CONSEQUENTIAL DAMAGES OR EXPENSES INCURRED BY THE ORIGINAL PURCHASER, OR FOR LABOR OR OTHER COSTS DUE TO INSTALLATION OR REMOVAL, OR COSTS OF REPAIRS BY OTHERS, OR FOR ANY OTHER EXPENSE NOT SPECIFICALLY STATED ABOVE. IN NO EVENT WILL TOTO'S RESPONSIBILITY EXCEED THE PURCHASE PRICE OF THE PRODUCT. EXCEPT TO THE EXTENT PROHIBITED BY APPLICABLE LAW, ANY IMPLIED WARRANTIES, INCLUDING THAT OF MERCHANTABILITY OR FITNESS FOR USE OR FOR A PARTICULAR PURPOSE, ARE EXPRESSLY DISCLAIMED. SOME STATES DO NOT ALLOW LIMITATIONS ON HOW LONG AN IMPLIED WARRANTY LASTS, OR THE EXCLUSION OR LIMITATION OF INCIDENTAL OR CONSEQUENTIAL DAMAGES, SO THE ABOVE LIMITATION AND EXCLUSION MAY NOT APPLY TO YOU.

TOTO[®]

©2009 TOTO[®] USA, Inc. 1155 Southern Road, Morrow GA 30260
Phone (888)-295-8134 Fax (800)-699-4889 www.totousa.com
TOTO[®] USA, INC. is a wholly owned subsidiary of TOTO[®] Ltd.