

Features

- 15" (381) x 15" (381) x 6" (152) top mount kitchen sink.
- Single compartment.
- 20 gauge 304 stainless steel.
- Center drain location.
- Brushed finish.
- 19mm radius corners.
- 3mm sound deadening pads.
- Fits 30" base cabinet width.

Components

Product includes:
Cutout Template
Installation Hardware
Installation Instructions

Options

- 2210R Covered Sink Strainer
- 4010 Covered Disposer Strainer
- TMTK1 Magnetic Tool Set

Warranty

- Lifetime Limited Warranty

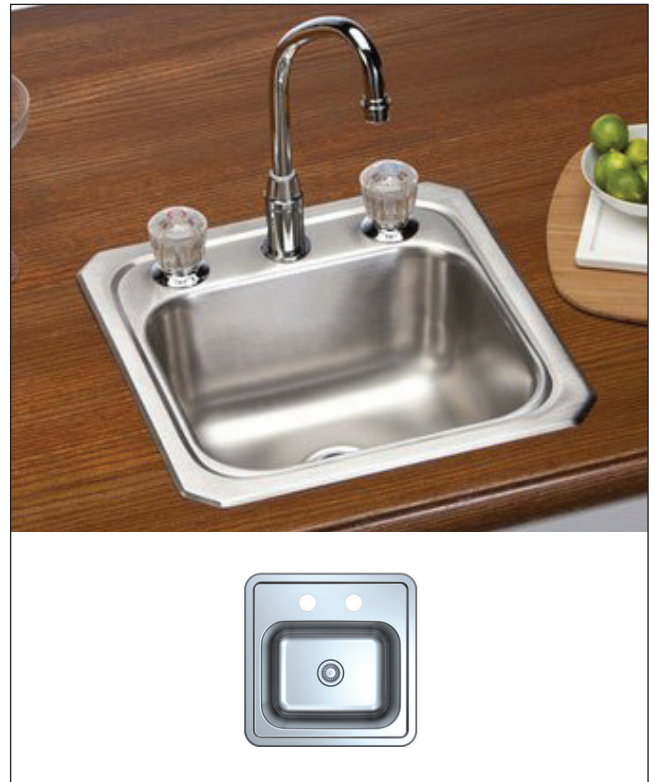

Specified Model

Model	STSB15156
Overall Dimensions	L15" x W15" x D6" 381 x 381 x 152
Bowl Dimensions	L12 ¹ / ₄ " x W9 ¹ / ₄ " x D6" 305 x 235 x 152
Drain hole:	2" (51mm)
Shipping Weight	8 lbs.
Material	20 gauge 304 stainless steel
Installation	counter top mounted
Required	template, included

To Be Specified:

see back for configurations available for this sink

Faucet Hole Drillings	
<input type="checkbox"/>	1 Hole
<input type="checkbox"/>	2 Holes

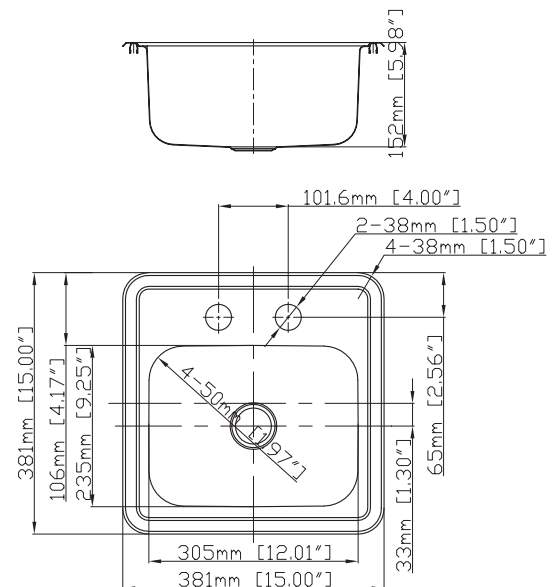

Codes/Standards

ASME A112.19.3/CSA B45.4

Notes

Install this product according to the installation instructions.

Faucet Hole Configurations available for this sink model

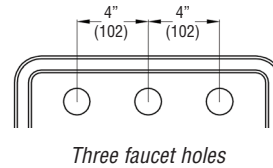
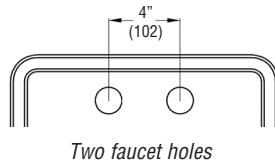
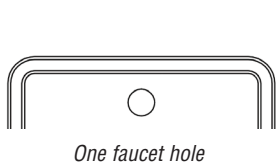

Optional Accessories

2210R Covered Flip Top Sink Strainer.

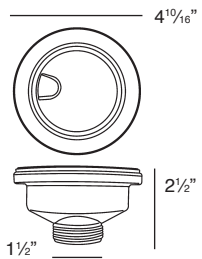

Water drains easily when cover is in place. Cover flips up with easy touch. Polypropylene housing. Fits standard 3 1/2" opening.

2310 Remote Covered Flip Top Sink Strainer.

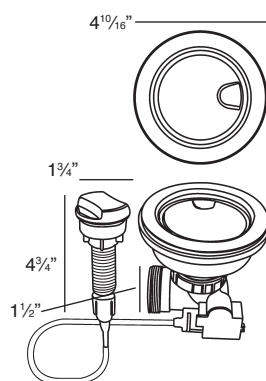

Turn the remote knob to open and close drain. Water drains easily when cover is in place. Cover flips up with easy touch. Polypropylene housing. Fits standard 3 1/2" opening. 1 3/8" hole required in countertop for remote installation. Remote cable 25 1/2" L.

4010 Covered Flip Top Disposer Strainer.

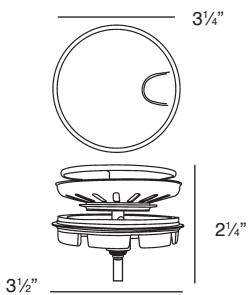

Water drains easily when cover is in place. Cover flips up with easy touch. Polypropylene housing. Top mount installation for 3 1/2" opening.